

# Farming freshwater prawns

A manual for the culture of the giant river prawn (*Macrobrachium rosenbergii*)

FAO  
FISHERIES  
TECHNICAL  
PAPER

428



# Farming freshwater prawns

A manual for the culture of the giant river prawn (*Macrobrachium rosenbergii*)

by

**Michael B. New**

Marlow, United Kingdom

The designations employed and the presentation of material in this information product do not imply the expression of any opinion whatsoever on the part of the Food and Agriculture Organization of the United Nations concerning the legal status of any country, territory, city or area or of its authorities, or concerning the delimitation of its frontiers or boundaries.

The mention of specific companies, their products or brand names does not imply any endorsement by the Food and Agriculture Organization of the United Nations.

ISBN 92-5-104811-8

All rights reserved. Reproduction and dissemination of material in this information product for educational or other non-commercial purposes are authorized without any prior written permission from the copyright holders provided the source is fully acknowledged. Reproduction of material in this information product for resale or other commercial purposes is prohibited without written permission of the copyright holders. Applications for such permission should be addressed to the Chief, Publishing Management Service, Information Division, FAO, Viale delle Terme di Caracalla, 00100 Rome, Italy or by e-mail to [copyright@fao.org](mailto:copyright@fao.org)

© FAO 2002

## PREPARATION OF THIS DOCUMENT

A **PREVIOUS MANUAL ON THIS TOPIC** was prepared for FAO in 1982 and revised in 1985 but the English edition is now out-of-print. Research has generated considerable benefits on this subject and substantial advances in technology have occurred since the original manual was published. These facts, combined with a revival in interest in expanding the farming of freshwater prawns, have created the need for a new technical manual.

This document has therefore been prepared to provide up-to-date and practical information on freshwater prawn farming. Its emphasis is on techniques for cultivating the major farmed species, namely the giant river prawn (*Macrobrachium rosenbergii*). The manual also contains information of relevance to the farming of other *Macrobrachium* species and to the enhancement of freshwater prawn fisheries.

The document was prepared under contract for the Inland Water Resources and Aquaculture Service, FAO Fishery Resources Division, by one of the authors of the original FAO manual, Michael B. New. It is a synthesis of the personal experience of the author and of his many international friends and colleagues working in this field, who are gratefully acknowledged within the manual text.

The principal targeted audience includes trainers, extension agents, farmers, and students. It is also hoped that the manual will provide background information and reference sources for those embarking on research in this field.

The designations employed and the presentation of material in this information product do not imply the expression of any opinion whatsoever on the part of the Food and Agriculture Organization of the United Nations concerning the legal status of any country, territory, city or area or of its authorities, or concerning the delimitation of its frontiers or boundaries.

The mention of specific companies, their products or brand names does not imply any endorsement by the Food and Agriculture Organization of the United Nations.

All rights reserved. Reproduction and dissemination of material in this information product for educational or other non-commercial purposes are authorized without any prior written permission from the copyright holders provided the source is fully acknowledged. Reproduction of material in this information product for resale or other commercial purposes is prohibited without written permission of the copyright holders. Applications for such permission should be addressed to the Chief, Publishing Management Service, Information Division, FAO, Viale delle Terme di Caracalla, 00100 Rome, Italy or by e-mail to [copyright@fao.org](mailto:copyright@fao.org)

# abstract

**THE ORIGINAL MANUAL** on freshwater prawn farming was published in English, French and Spanish by FAO and translated by others into Farsi, Hindi, and Vietnamese. In the two decades since that manual was written, many technical and practical advances have been made in the rearing of freshwater prawns. Greater farmed production, developing global markets, and the need to ensure that each form of aquaculture is sustainable, have led to an increased interest in the farming of freshwater prawns. A new manual has therefore been prepared, which will be issued in each of the FAO official languages.

This manual provides information on the farming of *Macrobrachium rosenbergii*. Many of the techniques described are also applicable to other species of freshwater prawns that are being cultured. The manual is not a scientific text but is intended to be a practical guide to in-hatchery and on-farm management. The target audience is therefore principally farmers and extension workers. However, it is also hoped that, like the previous manual on this topic, it will be useful for lecturers and students alike in universities and other institutes that provide training in aquaculture.

After a preliminary section on the biology of freshwater prawns, the manual covers site selection for hatcheries, nurseries and grow-out facilities, and the management of the broodstock, hatchery, nursery and grow-out phases of rearing. Harvesting and post-harvest handling are also covered and there are some notes on marketing freshwater prawns. The reference and bibliography section is generally restricted to a list of relevant reviews, as well as other (mainly FAO) manuals on general aquaculture themes, such as water and soil management, topography, pond construction and simple economics. Every attempt has been made to illustrate the management principles described in this manual by photographs and drawings. The manual contains many annexes on specific topics, such as the production of larval feeds, size variation and stock estimation. The final annex is a glossary; this lists not only terms used in the manual itself but also terms which the readers may find in other documents that they may consult.

**Key words:** *Macrobrachium*, broodstock management, crustacean culture, freshwater prawns, hatchery operation, grow-out procedures, post-harvest handling and marketing, site selection

# preface

**AN EARLIER FAO MANUAL** on freshwater prawn culture was written by the former Co-Managers of the UNDP/FAO Programme for the Expansion of Freshwater Prawn Farming in Thailand, Michael New and Somsak Singholka, which was based substantially on their personal experience. The English version was issued in 1982 (New and Singholka, 1982) and FAO published it in Spanish in 1984 and in French in 1985. A minor revision of the English edition was made when it was reprinted in 1985. With the support of local funding, the manual was also translated and published in Vietnamese in 1990, in Farsi in 1991, and in Hindi in 1996. A number of freshwater prawn manuals by other authors, which were published in English, French, Portuguese and Spanish between 1985 and 1993, are listed in a review of the history of freshwater prawn farming by New (2000a). Many technological advances were made in freshwater prawn culture in the final two decades of the 20th century, and a number of other FAO manuals on general but relevant aquacultural topics were issued during that period (e.g. FAO 1981, 1985, 1988, 1989b, 1992a, 1992b, 1994, 1995, 1996, 1998; Lavens and Sorgeloos 1996; Tave 1996, 1999; Moretti, Pedini Fernandez-Criado, Cittolin and Guidastrì 1999).

In the two decades since the original FAO freshwater prawn manual was published, production from the farming of *Macrobrachium rosenbergii* has expanded considerably, mainly in Asia but also in South and North America. Thai farmed freshwater prawn production expanded from less than 250 mt in 1979 (New, Singholka and Vorasayan 1982) to about 3 100 mt in 1984 (FAO 1989a). In 1984, the total global production of farmed *Macrobrachium rosenbergii* was only about 5 000 mt (FAO 1989a). By 2000, official FAO data indicate that global production of *M. rosenbergii* had risen to nearly 119 000 mt, to which Thailand contributed 3 700 mt (FAO 2002). China, which introduced this species in 1976 (New 2000b), produced over 97 000 mt in 2000. The official FAO production statistics for this species are underestimates, because some countries have not yet disaggregated their production from more general statistical categories such as 'freshwater prawns and shrimps nei\*' or 'freshwater crustaceans nei\*'. In addition, several other freshwater prawn species are now cultured in pilot or full commercial scale, including *M. amazonicum*, *M. malcolmsonii* and *M. nipponense* (Kutty, Herman and Le Menn 2000) but production data for these species is not yet reported to FAO. Farmed production of *M. nipponense* in China was estimated to be 100 000 mt in 2000 (Miao and Ge 2002), confirming a forecast that total annual production of all freshwater prawn species would reach 200 000 mt early in the new millennium (New 2000a). Some believe that freshwater prawn farming may be more sustainable than marine shrimp farming (New, D'Abramo, Valenti and Singholka 2000).

This renewed interest in freshwater prawn farming provided the stimulus for the preparation of a new FAO manual on the topic. In preparing this manual, the author has drawn heavily on information gained during the editing of a recent academic book on the topic (New and Valenti 2000). The author and the FAO Fisheries Department hope that it will prove useful in further encouraging the culture of freshwater prawns. Translations of the new manual into Arabic, Chinese, French and Spanish will be issued in 2002-2003.

---

\* not elsewhere included

# table of contents

<b>ABSTRACT</b>	<b>iii</b>
<b>PREFACE</b>	<b>v</b>
<b>INTRODUCTION</b>	<b>xiii</b>
<b>1. Biology</b>	<b>1</b>
<b>1.1 Names, natural range, and characteristics of freshwater prawns</b>	<b>1</b>
Naming freshwater prawns (nomenclature)	1
The natural home of freshwater prawns (distribution)	2
Identifying <i>Macrobrachium rosenbergii</i> from other freshwater prawn species	2
<b>1.2 The shape (external morphology) and other characteristics of freshwater prawns</b>	<b>3</b>
<b>1.3 Life history</b>	<b>8</b>
<b>1.4 Sources of further biological information</b>	<b>10</b>
<b>2. Site selection</b>	<b>11</b>
<b>2.1 Hatcheries and indoor nurseries</b>	<b>11</b>
Needs for good quality water	11
Deciding how much water is needed	15
Other requirements for hatchery sites	16
<b>2.2 Outdoor nurseries and grow-out facilities</b>	<b>16</b>
Choosing your site: topography and access	18
Choosing your site: climate	19
Choosing your site: water quality and supply	19
Choosing your site: soil characteristics	24
Choosing your site: power supplies	24
Choosing your site: fry and consumables	25
Choosing your site: labour	26
Choosing your site: sympathetic authorities and technical assistance	26
<b>3. Broodstock</b>	<b>27</b>
<b>3.1 Obtaining and selecting egg-carrying females</b>	<b>27</b>
Obtaining berried females	27
Genetic improvement	28
<b>3.2 Holding your broodstock in temperate zones</b>	<b>30</b>
<b>3.3 Managing your broodstock</b>	<b>30</b>

<b>4.</b>	<b>Hatchery phase</b>	<b>35</b>
<b>4.1</b>	<b>Buildings and equipment facilities</b>	<b>36</b>
	Basic site and building requirements	36
	Equipment and the distribution of water and air	37
<b>4.2</b>	<b>Hatchery management</b>	<b>54</b>
	Water treatment	54
	Starting your larval batch	55
	Routine work	57
	Feeding	60
	Hygiene, health and management problems	65
	Monitoring performance	70
	The greenwater system of freshwater prawn culture	73
<b>4.3</b>	<b>Harvesting postlarvae</b>	<b>73</b>
<b>5.</b>	<b>Postlarval holding and nursery phases</b>	<b>75</b>
<b>5.1</b>	<b>Basic requirements and facilities</b>	<b>75</b>
	Holding tanks	75
	Indoor (primary) nursery facilities	75
	Outdoor (secondary) nursery facilities	76
	Nursery cages	77
<b>5.2</b>	<b>Holding postlarvae before sale</b>	<b>77</b>
<b>5.3</b>	<b>Transporting postlarvae</b>	<b>78</b>
<b>5.4</b>	<b>Managing nurseries</b>	<b>80</b>
	Indoor (primary) nurseries	80
	Outdoor (secondary) nurseries	82
	Other systems	83
<b>6.</b>	<b>Grow-out phase</b>	<b>85</b>
<b>6.1</b>	<b>Site requirements and construction</b>	<b>85</b>
	Defining the pond	86
	Supplying water to the ponds	90
	Discharging water from the ponds	95
	Aeration	96
	Miscellaneous	97
<b>6.2</b>	<b>Management of the grow-out phase</b>	<b>99</b>
	Size variation	100
	Semi-intensive monoculture in tropical zones	100
	Monoculture in temperate zones	108
	Polyculture and integrated culture	111
<b>6.3</b>	<b>Feeding and fertilization</b>	<b>114</b>



Feed type	114
Measuring feed efficiency	119
Feeding rate	119
<b>6.4 Health, predation and disease</b>	<b>121</b>
Watching for signs of problems	121
Dealing with problems of predation	122
Coping with diseases and other problems	123
<b>6.5 Monitoring performance and record keeping</b>	<b>125</b>
<b>7. Harvesting and post-harvest handling</b>	<b>129</b>
<b>7.1 Harvesting your market-sized prawns</b>	<b>129</b>
Cull harvesting	130
Drain harvesting	133
<b>7.2 Handling your prawns after harvest and ensuring good product quality</b>	<b>136</b>
Handling prawns to be sold fresh	136
Handling prawns to be sold frozen	137
Handling for live sales	138
<b>7.3 Code of practice for harvesting, processing and handling prawns</b>	<b>139</b>
<b>8. Marketing</b>	<b>141</b>
<b>9.1 Marketing your freshwater prawns alive</b>	<b>141</b>
<b>9.2 Marketing your freshwater prawns fresh or frozen</b>	<b>142</b>
<b>9.3 Marketing your freshwater prawns at your farm gate</b>	<b>142</b>
<b>9.4 International opportunities and general marketing strategy</b>	<b>144</b>
<b>Annexes</b>	
<b>1. Key to larval stages of freshwater prawns (<i>Macrobrachium rosenbergii</i>)</b>	<b>145</b>
<b>2. Natural beach filter for seawater</b>	<b>147</b>
<b>3. Maturation diets for broodstock freshwater prawns</b>	<b>151</b>
<b>4. Source, hatching and enrichment of <i>Artemia</i></b>	<b>153</b>
<b>5. Production of farm-made larval feeds</b>	<b>167</b>
<b>6. Stock estimation</b>	<b>169</b>
<b>7. Seine nets</b>	<b>173</b>
<b>8. Size management</b>	<b>177</b>
<b>9. Farm-made pond feeds</b>	<b>185</b>
<b>10. Basic code for introductions</b>	<b>191</b>
<b>11. Glossary of terms, abbreviations and conversions</b>	<b>193</b>
<b>FINANCIAL CONSIDERATIONS</b>	<b>203</b>
<b>ACKNOWLEDGEMENTS</b>	<b>205</b>
<b>REFERENCES</b>	<b>207</b>

## TABLES

---

1.	Body segments (somites) in <i>Macrobrachium rosenbergii</i> and appendage function	6
2.	Characteristics of water suitable for freshwater prawn hatcheries	15
3.	Artificial brackishwater (12 ppt) for <i>M. rosenbergii</i> hatcheries	16
4.	Diluting seawater and brine to make brackishwater for larval freshwater prawn culture	18
5.	Water quality requirements for freshwater prawn nursery and grow-out facilities	20
6.	Example of water requirements for ponds based on various assumptions	23
7.	Relationship between temperature, salinity and dissolved oxygen saturation levels	44
8.	Hatchery feeding schedule	63
9.	Alternative hatchery feeding schedule	64
10.	The major diseases known to affect freshwater prawns, and their exterior symptoms	67
11.	Prevention and treatment of freshwater prawn diseases	68
12.	Water discharge capacity of concrete pipes under various pressure heads	93
13.	Sizes of outlet pipes for ponds with monks	95
14.	Time taken to drain ponds with different drain pipe sizes	96
15.	Oxygen transfer efficiencies of basic types of aerator	97
16.	Lime requirements for treating the bottom of ponds between cycles	105
17.	Average stocking densities and yields in polyculture	112
18.	Examples of major ingredients in grow-out feeds	117
19.	Tentative specifications for semi-intensive freshwater prawn grow-out feeds	118
20.	General recommendations for handling and storing freshwater prawns	143

## BOXES

---

1.	Removal of iron and manganese	14
2.	Flow-through requirements for larval rearing tanks	17
3.	Grow-out water requirements	22
4.	Numbers of berried females required	28
5.	Activating biofilters	53
6.	Treatment of brackishwater	54
7.	Regular monitoring of larval water quality	55
8.	Alternative larval stocking strategies	57
9.	Recommendations for good larval water quality	59
10.	Maintenance schedule for recirculation systems	62
11.	Feeding BSN depends on tank volume, not the number of larvae in it	63
12.	Additional recommendations for recirculation system hygiene	66
13.	Notes on potential disease problems	69
14.	Definitions of farming intensity used in this manual	101
15.	Systems of management in grow-out ponds for freshwater prawns	102-103
16.	Application of rotenone and teaseed cake	104

17.	Measuring soil pH	106
18.	Reasons for not applying organic fertilizers	107
19.	Keeping rooted plants out of your ponds	109
20.	Size grading	110
21.	Polyculture of freshwater prawns with carps	113
22.	Examples of integrated freshwater prawn culture	115
23.	Example of feeding rate for freshwater prawns	121
24.	Examples of freshwater prawn ( <i>M. rosenbergii</i> ) growth and production rates	126

## FIGURES

---

1.	External appearance	3
2.	Large males	5
3.	Sexing juveniles	7
4.	Females with a BC male	7
5.	Male morphotypes	8
6.	Freshwater prawns compared to penaeid shrimp	8
7.	Another way of distinguishing carideans from penaeids	9
8.	Grow-out pond inlets and screens	21
9.	Simple pumps	25
10.	Expensive pumps	25
11.	Berried females	29
12.	Hatching system	31
13.	Airlift pumps	32-33
14.	Small hatcheries	36-37
15.	Partially covered larval tanks	37
16.	Hatchery layout	38
17.	Water flow through a recirculation system	39
18.	Spaces round tanks	39
19.	Cylindrico-conical larval tank	40
20.	Grouping tanks together	40
21.	Shared filter	41
22.	Individual recirculation systems	41
23.	Filter sock	42
24.	Turn-down drains	43
25.	Storage tanks	43
26.	Ring main air supply	45
27.	Tank taps	46
28.	Air blowers and emergency power supplies	47
29.	Water distribution	48
30.	Physical hatchery filters	50
31.	Close-up of a shared biological filter	51
32.	Types of biological filters	52
33.	White board	56
34.	Tank cleaning	60
35.	Reducing losses	61
36.	Observing larval quality	71-72
37.	Additional substrates in holding tanks	76

38.	Overhead air and water distribution systems	76
39.	Substrates	77
40.	Pond with standpipe drain	77
41.	Transporting postlarvae	79
42.	Substrate in a larval tank	81
43.	Large freshwater prawn farm	86
44.	Pond bottom profiles	87
45.	Improving pond banks	88
46.	Angles of pond bank slope	89
47.	Erosion	89
48.	Grass on pond banks	89
49.	Pond banks with integrated agriculture	90
50.	Increasing dissolved oxygen levels in incoming water	91
51.	Simple gravel filters	91
52.	Water distribution system to ponds	92
53.	Supplying water by gravity	93
54.	Grass minimizes erosion	93
55.	Controlling water entry	94
56.	Outlet structure	95
57.	Cast netting	96
58.	Draining	97
59.	Screening pond outlets	98-99
60.	Long-tail pump	99
61.	Long-tail pump being used	99
62.	Paddlewheel aerator	100
63.	Long-shaft aerator	100
64.	Long-shaft aerator in action	101
65.	Pond sedimentation	104
66.	Tilling the pond bottom	105
67.	Juvenile prawns	106
68.	Acclimatizing prawns before stocking	107
69.	Releasing prawns during stocking	108
70.	Weeds invade shallow areas	108
71.	Close-up of pond substrate	109
72.	Substrates placed vertically	109
73.	Substrates placed horizontally	110
74.	Integrated freshwater prawn farming	114
75.	Catching wild postlarvae	116
76.	Feed distribution	120
77.	Observing feed consumption	120
78.	Measuring transparency	122
79.	Simple gravel filter	123
80.	Protection from overland predators	123
81.	Large BC <i>Macrobrachium rosenbergii</i> being measured	127
82.	Relationship between total length and weight	127
83.	Seining	131
84.	Double seining	132
85.	Multiple seining	133
86.	Sorting prawns	133

87.	Keeping market-sized prawns alive during harvesting	133
88.	Keeping prawns in peak condition	134
89.	Checking prawn health	134
90.	Internal harvesting sump	134
91.	Harvesting with an internal sump	135
92.	Cull-harvesting	135
93.	Catching the last few prawns by hand	136
94.	Bird predation	136
95.	Kill-chilling harvested prawns	137
96.	Sorting during processing	138
97.	Packaging prawns attractively	138
98.	Recently harvested prawns	139
99.	Advertising freshwater prawns at the farm gate	143
100.	Selling prawns in a supermarket	144



# Introduction

**THE WORDS 'PRAWN' AND 'SHRIMP'** are often used synonymously. Actual use is geographically dependent. For example, animals of the genus *Macrobrachium* are referred to as freshwater prawns in Australia and freshwater shrimp in the United States of America (USA). In its statistical data, FAO refers to the genus *Macrobrachium* as freshwater prawns but also uses the word prawn for many species of marine shrimp, including the banana prawn (*Fenneropenaeus merguensis*), the giant tiger prawn (*Penaeus monodon*) and the kuruma prawn (*Marsupenaeus japonicus*) (FAO 2001).

This manual is intended to be a practical guide to the farming of freshwater prawns and is meant primarily for extension, rather than research workers. Its contents are a synthesis of practical experience and published information. The manual also has some relevance for the enhancement of freshwater prawn fisheries, since this requires the provision of hatchery-reared animals for stocking purposes. The introduction of *M. rosenbergii* and related species into reservoirs and the enhancement of existing capture fisheries has had some current success, notably in Brazil, India and Thailand. Further developments will require hatchery-reared postlarvae (PL) and juveniles for stocking purposes. Although the new manual is primarily concerned with aquaculture, parts of it (particularly the sections on broodstock, hatchery management and marketing) are also relevant to the enhancement of freshwater prawn fisheries. Further reading on the topic of capture fisheries and enhancement is available in New, Singholka and Kutty (2000). Those interested in the science that supports freshwater prawn farming can find a comprehensive review in New and Valenti (2000).

Although several species of freshwater prawns are currently being cultured, this manual deals exclusively with the farming of the major commercial species (*Macrobrachium rosenbergii*), which is indigenous to South and Southeast Asia, parts of Oceania and some Pacific islands. *M. rosenbergii* has been imported into many other tropical and subtropical areas of the world and is the species most favoured for farming purposes. The use of the words 'freshwater prawns' and 'prawns' in this manual, except where otherwise specifically qualified, refers to *M. rosenbergii*. This species remains by far the

major subject of cultivation because a global market for it evolved during the 1990s and is currently being further developed. Other species of *Macrobrachium* are now also being farmed, mainly for domestic consumption, and modifications of the techniques described in this manual can be derived to support this development. Such modifications need to take account of the different environmental requirements of the other species, especially in the larval stages. Reference to the culture of other *Macrobrachium* spp. is contained in Kutty, Herman and Le Menn (2000).

In the previous FAO manual on this topic, the hatchery and pond-rearing techniques described were generally based on those applied in freshwater prawn culture in Thailand in the early 1980s. Only one system of culture, namely the operation of flow-through hatcheries followed by monoculture in ponds, was fully described. This manual broadens the scope by drawing on experience in recirculation hatcheries and monoculture from other countries, notably Brazil and the USA, and by stressing the opportunities for alternative systems of grow-out, including polyculture and integrated culture

After a brief section on the biology of *M. rosenbergii*, the manual deals with the selection of sites for hatchery and grow-out facilities. It then covers the maintenance of brood-stock and the management of the hatchery, nursery and grow-out phases. Following a section on harvesting and the post-harvest handling of market-sized prawns, the manual includes a section on marketing, an important topic that was not covered in the previous document. The text of the manual concludes with some references to financial matters and a short bibliography for further reading. Several other important topics, such as the preparation of feed for freshwater prawn larvae, and a glossary, are provided in the annexes. General background information, which should be useful for extension workers and students is provided in the introduction and in Chapter 1. Chapters 2-8 (especially sections 3-6) and the annexes contain the main technical content of the manual, which is of direct relevance for farmers as well as students and extension workers. The different audiences addressed by various parts of the manual are reflected by the writing style chosen for each section. As far as possible, the technical sections that are specific to the hatchery and grow-out management of freshwater prawns (especially the material presented in text 'Boxes' are written in 'cookbook' English, whereas more 'scientific' language is used in Chapter 1 and some of the annexes, for example.

The author and the FAO Fisheries Department hope that you will find the manual useful and stimulating, and would welcome constructive criticism, so that the manual may be improved in future editions.



# Biology

**THE FOLLOWING NOTES** contain background information on the genus *Macrobrachium* and some basic details about the biology of *M. rosenbergii*. This section of the manual has mainly been derived from Holthuis (2000), the work of Ling (1969), and a review by Ismael and New (2000), and is intended to provide basic background information for extension workers and students.

## 1.1 Names, natural range, and characteristics of freshwater prawns

---

### NAMING FRESHWATER PRAWNS (NOMENCLATURE)

All the freshwater prawns that have been cultured so far belong to the genus *Macrobrachium*, Bate 1868, the largest genus of the family Palaemonidae. About 200 species have been described, almost all of which live in freshwater at least for part of their life.

The giant river prawn, *Macrobrachium rosenbergii*, was one of the first species to become scientifically known, the first recognisable illustration appearing in 1705. The nomenclature of freshwater prawns, both on a generic and a species level has had quite a muddled history. In the past, generic names have included *Cancer* (*Astacus*) and *Palaemon*. Previous names of *M. rosenbergii* have included *Palaemon carcinus*, *P. dacqueti*, and *P. rosenbergii* and it was not until 1959 that its present scientific name, *Macrobrachium rosenbergii* (De Man 1879) became universally accepted.

Some taxonomists recognize a western sub-species (found in the waters of the east coast of India, Bay of Bengal, Gulf of Thailand, Malaysia, and the Indonesian regions of Sumatra, Java and Kalimantan) and an eastern sub-species (inhabiting the Philippines, the Indonesian regions of Sulawesi and Irian Jaya, Papua New Guinea and northern Australia). These are referred to as *Macrobrachium rosenbergii dacqueti* (Sunier 1925) for the western form and *Macrobrachium rosenbergii rosenbergii* (De Man 1879) for the eastern form. However, from the perspective of freshwater prawn farmers, exact nomenclature



has little relevance, especially because the species *M. rosenbergii* has been transferred within its natural geographical range and been introduced into many other zones where it may become established.

## THE NATURAL HOME OF FRESHWATER PRAWNS (DISTRIBUTION)

Species of the freshwater prawn genus *Macrobrachium* are distributed throughout the tropical and subtropical zones of the world. Holthuis (1980) provides useful information on the distribution, local names, habitats and maximum sizes of commercial (fished and farmed) species of *Macrobrachium*.

They are found in most inland freshwater areas including lakes, rivers, swamps, irrigation ditches, canals and ponds, as well as in estuarine areas. Most species require brackishwater in the initial stages of their life cycle (and therefore they are found in water that is directly or indirectly connected with the sea) although some complete their cycle in inland saline and freshwater lakes. Some species prefer rivers containing clear water, while others are found in extremely turbid conditions. *M. rosenbergii* is an example of the latter.

There is a wide interspecific variation in maximum size and growth rate, *M. rosenbergii*, *M. americanum*, *M. carcinus*, *M. malcolmsonii*, *M. choprai*, *M. vollenhovenii* and *M. lar* being the largest species known. *M. americanum* (Cauque river prawn) is found naturally in western watersheds of the Americas while *M. carcinus* (painted river prawn) is found in those connected with the Atlantic. *M. choprai* (Ganges river prawn) is found in the Ganges and Brahmaputra river systems. *M. lar* (Monkey river prawn) is native from East Africa to the Marquesas Islands of the Pacific (and was introduced into Hawaii). *M. malcolmsonii* (monsoon river prawn) is found in the waters of Bangladesh, India and Pakistan. *M. rosenbergii* (giant river prawn) is indigenous in the whole of the South and Southeast Asian area as well as in northern Oceania and in the western Pacific islands. *M. vollenhovenii* (African river prawn) is naturally distributed in West Africa, from Senegal to Angola.

Many *Macrobrachium* species have been transferred from their natural location to other parts of the world, initially for research purposes. *M. rosenbergii* remains the species most used for commercial farming and consequently is the one which has been introduced to more countries. Following its import into Hawaii from Malaysia in 1965, where the pioneer work of Ling (1969) was translated into a method for the mass production of postlarvae (PL) by Fujimura and Okamoto (1972), it has been introduced into almost every continent for farming purposes. *M. rosenbergii* is now farmed in many countries; the major producers (>200 mt) are Bangladesh, Brazil, China, Ecuador, India, Malaysia, Taiwan Province of China, and Thailand (FAO 2002). More than thirty other countries reported production of this species in the year 2000. Viet Nam is also a major producer, according to New (2000b). In addition, there are also valuable capture fisheries for *M. rosenbergii*, for example in Bangladesh, India, and several countries in Southeast Asia.

## IDENTIFYING *MACROBRACHIUM ROSENBERGII* FROM OTHER FRESHWATER PRAWN SPECIES

*Macrobrachium rosenbergii* (Figure 1) can be distinguished from other species in the genus by the following characteristics (the morphological terms used below are explained in the glossary – Annex 11):

- it has a very long rostrum, with 11-14 dorsal teeth and 8-10 ventral teeth (the ventral characteristics are especially important);
- the tip of its telson reaches distinctly beyond the posterior spines of the telson;

The external features of *Macrobrachium rosenbergii*

NOTE: OTHER CARIDEAN PRAWNS HAVE SIMILAR CHARACTERISTICS BUT SOME (E.G. *PANDALUS*, *CRANGON*, *PALAEEMON*) ARE MARINE

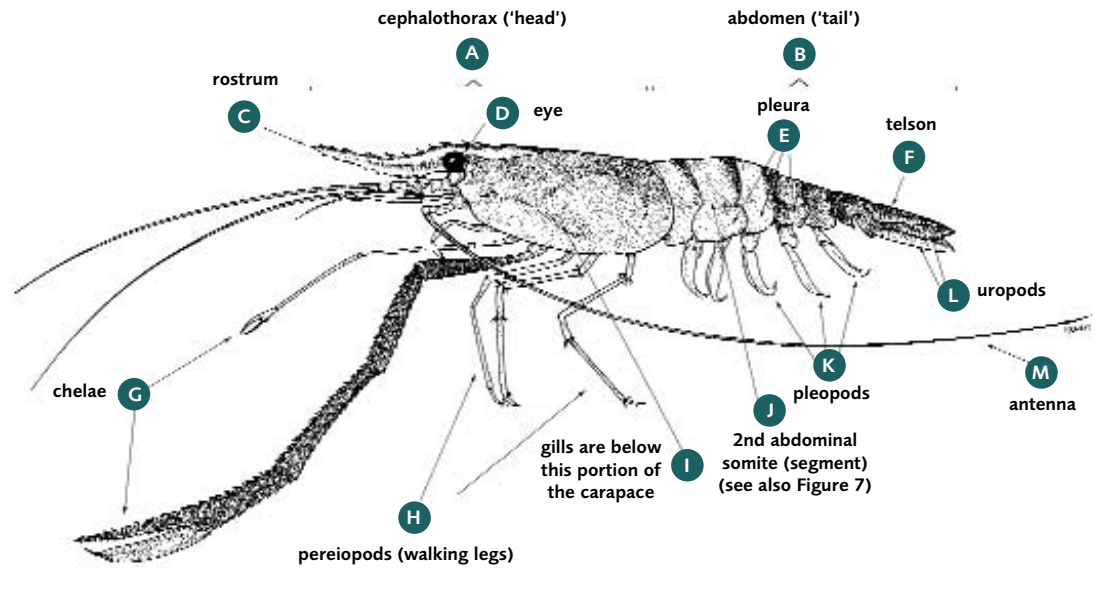

SOURCE: EMANUELA D'ANTONI

- the adult male has very long second chelipeds in which all segments are elongate and have blunt spines;
- the movable finger of the second chelipeds of the adult male is covered by a dense velvet-like fur (except the extreme tip) but this fur is absent from the fixed finger and the rest of the cheliped; and
- it is the largest known of all *Macrobrachium* species, adult males having been reported with a total body length of up to 33 cm, and adult females of up to 29 cm.

## 1.2 The shape (external morphology) and other characteristics of freshwater prawns

The following information deals with the general external anatomy of the freshwater prawn *M. rosenbergii*, and provides some notes on the function of various major parts of the body. Internal morphology (circulatory, respiratory, digestive, excretory, reproductive and nervous systems) is not covered in this manual, which concentrates on farming, but further information is available in the references cited in the introduction to this section.

Freshwater prawn eggs of this species are slightly elliptical, with a long axis of 0.6-0.7 mm, and are bright orange in colour until 2-3 days before hatching when they become grey-black. This colour change occurs as the embryos utilize their food reserves.

Most scientists accept that the larvae go through 11 distinct stages (Uno and Kwon 1969) before metamorphosis, each with several distinguishing features which are described and illustrated in Annex 1. However, from stage VI onwards their size is variable, which has led to some workers, notably Ling (1969) to describe only eight stages. Stage I larvae

(zoeae) are just under 2 mm long (from the tip of the rostrum to the tip of the telson). Larvae swim upside down by using their thoracic appendages and are positively attracted to light. By stage XI they are about 7.7 mm long. Newly metamorphosed postlarvae (PL) are also about 7.7 mm long and are characterized by the fact that they move and swim in the same way as adult prawns. They are generally translucent and have a light orange-pink head area.

The body of postlarval and adult prawns consists of the cephalothorax ('head') and the abdomen ('tail'). The bodies of freshwater prawns are divided into twenty segments (known as somites). There are 14 segments in the head, which are fused together and invisible under a large dorsal and lateral shield, known as the carapace. The carapace is hard and smooth, except for two spines on either side; one (the antennal spine) is just below the orbit and the other (the hepatic spine) is lower down and behind the antennal spine. The carapace ends at the front in a long beak or rostrum, which is slender and curved upwards. The rostrum extends further forward than the antennal scale and has 11-14 teeth on the top and 8-10 underneath (Figure 1). The first two of the dorsal (top side) teeth appear behind the eye socket (orbit).

The front portion of the cephalothorax, known as the cephalon, has six segments and includes the eyes and five pairs of appendages. The final three of these six segments can be seen if the animal is turned upside down and the appendages of the thorax (see below) are moved aside. The cephalon segments therefore support, from the front of the animal:

- the stalked eyes;
- the first antennae, which each have three-segment peduncles (stalks) from which three tactile flagella emerge;
- the second antennae, which each have five-segment peduncles and a single, long flagellum;
- the mandibles, which are short and hard and are used to grind food;
- the first maxillae, which are plate-like (lamelliform), hidden below the second maxillae, and used to transfer food into the mouth; and
- the second maxillae, which are similar to the first maxillae but have an additional function. Part of these appendages are constantly beating, thus producing a current of water through the gill chamber to promote the respiratory function of the latter.

The two pairs of antennae are the most important sites of sensory perception; the peduncles of the first antennae contain a statocyst, which is a gravity receptor. The mandibles and first and second maxillae form part of the six sets of mouthparts (see below).

The rear portion of the cephalothorax, known as the thorax, consists of 8 fused segments which have easily visible pairs of appendages. These appendages consist of 3 sets of maxillipeds and 5 pairs of pereopods, as follows:

- the first and second maxillipeds are similar to the first and second maxillae and function as mouthparts (see above);
- the third maxillipeds, which are also mouthparts but look rather like legs;
- the first and second legs (pereopods), which have pincers (chelae). These pincer-ended legs are also called chelipeds. The first legs are slender but the second pair bear numerous small spines and are much stronger than any other leg. The second chelipeds are used for capturing food, as well as in mating and agonistic (fighting) behaviour; and
- the third, fourth and fifth legs (pereopods), which are much shorter than the second cheliped, have simple claws (not pincers), and are sometimes called walking legs.

Eggs are extruded from oval gonopores in the base of the third pereopods of females, which are covered with a membrane. In males, sperm is extruded from gonopores which are covered by flaps, situated in the base of the fifth pereopods.

The pereopods include chemoreceptor cells, which are sensitive to aqueous extracts of food and to salts (and may therefore be involved in migratory and reproductive processes). The left and right second legs (chelipeds) of *M. rosenbergii* are equal in size, unlike some other *Macrobrachium* spp. In adult males they become extremely long and reach well beyond the tip of the rostrum. Some extreme examples are shown in Figure 2.

The tail (abdomen) is very clearly divided into 6 segments, each bearing a pair of appendages known as pleopods or swimmerets (as this name implies, they are used for swimming, in contrast to the walking legs). The first five pairs of swimmerets are soft. In females they have attachment sites for holding clusters of eggs within the brood chamber (see below). In males, the second pair of swimmerets is modified for use in copulation. This spinous projection is known as the appendix masculina. The sixth pair of swimmerets, known as uropods, are stiff and hard. The telson is a central appendage on the last segment and has a broad point with two small spines which project further behind the point. The telson and the uropods form the tail fan, which can be used to move the prawn suddenly backwards.

A summary of the segments and the functions of each appendage is provided in Table 1.

Postlarval prawns are usually a greenish-brownish grey and sometimes blue. Normally there are irregular brown, grey and whitish longitudinal streaks on the body. Orange spots may be visible where the tail segments bend. The lateral ridge of the rostrum may be red. The antennae are often blue. The chelipeds are generally blue but the second chelipeds may also be orange (see below). The colour of the bodies of prawns tends to be brighter in younger animals and generally darker and blue or brownish in older prawns (they become red when cooked).

Mature male prawns are considerably larger than the females and the second chelipeds are much larger and thicker. The head of the male is also proportionately larger, and the abdomen is narrower. As noted above, the genital pores of the male are between at the base of the fifth walking legs. The head of the mature female and its second walking legs are much smaller than the adult male. The female genital pores are at the base of the third walking legs. An alternative technique for sexing juvenile prawns is shown in Figure 3. The pleura (overhanging sides of the abdominal segments) are longer in females than in males, and the abdomen itself is broader. These pleura of the first, second and third tail segments of females form a brood chamber in which the eggs are carried between laying and hatching. A ripe or 'ovigerous' female can easily be detected because the ovaries can be seen as large orange-coloured masses occupying a large portion of the dorsal and lateral parts of the cephalothorax.

**Figure 2**  
These very large *Macrobrachium rosenbergii* males were obtained from a fisheries enhancement programme (India)



**SOURCE:** METHIL NARAYANAN KUTTY

**TABLE 1** Body segments (somites) in *Macrobrachium rosenbergii* and appendage function

BODY SECTION	SOMITE #	APPENDAGE NAMES (PAIRS)	FUNCTIONS OF APPENDAGES AND RELATED STRUCTURES
<b>Cephalon</b> <i>front portion of the cephalothorax</i>	1	embryonic segment (not visible in adults)	
	2	1st antennae	tactile and sensory perception (statocyst)
	3	2nd antennae	tactile
	4	mandibles	cutting and grinding food
	5	1st maxillae (maxillulae)	food handling
	6	2nd maxillae	food handling; water circulation through the gill chamber (scaphognathite)
<b>Thorax</b> <i>rear portion of the cephalothorax</i>	7	1st maxillipeds	feeding/food handling
	8	2nd maxillipeds	feeding/food handling
	9	3rd maxillipeds	feeding/food handling
	10	1st pereopods (chelipeds)	food capture
	11	2nd pereopods (chelipeds)	food capture; agonistic and mating behaviour
	12	3rd pereopods	walking; female gonophores between base of legs
	13	4th pereopods	walking
	14	5th pereopods	walking; male gonophores between base of legs
<b>Abdomen</b>	15	1st pleopods (swimmerets)	swimming
	16	2nd pleopods (swimmerets)	swimming; copulation in males
	17	3rd pleopods (swimmerets)	swimming
	18	4th pleopods (swimmerets)	swimming
	19	5th pleopods (swimmerets)	swimming
	20	uropods	propulsion, together with the central telson

SOURCE: DERIVED FROM PINHEIRO AND HEBLING (1998)

Female prawns are sometimes referred to as virgin females (V or VF), berried (egg carrying) females (BE or BF) and open brood chamber (spent) females (OP). Egg-carrying females are shown in Figure 4. There are three major types of freshwater prawn males and a number of intermediate forms, which were not fully described in the original FAO manual. All three major types of males are illustrated in Figure 5. The ability to distinguish between these forms is important in understanding the need for size management during the grow-out phase of culture (Annex 8). The first type consists of blue claw males (BC), which have extremely long claws. The second type of males, sometimes known as runts, have small claws and are now called small males (SM). Although this type is similar in size

# 3

## FIGURE

### How to sex juvenile *Macrobrachium rosenbergii*

NOTE: EXAMINE THE VENTRAL SIDE OF THE FIRST SOMITE (SEGMENT) OF THE ABDOMEN; MALES HAVE A LUMP OR POINT IN THE CENTRE OF THE SOMITE WHICH CAN BE FELT WITH THE FINGER

- A ventral view of 1<sup>st</sup> abdominal somite of male and female
- B ventral view of 2<sup>nd</sup> abdominal somites
- C towards the head
- D cross section of male 1<sup>st</sup> abdominal segment

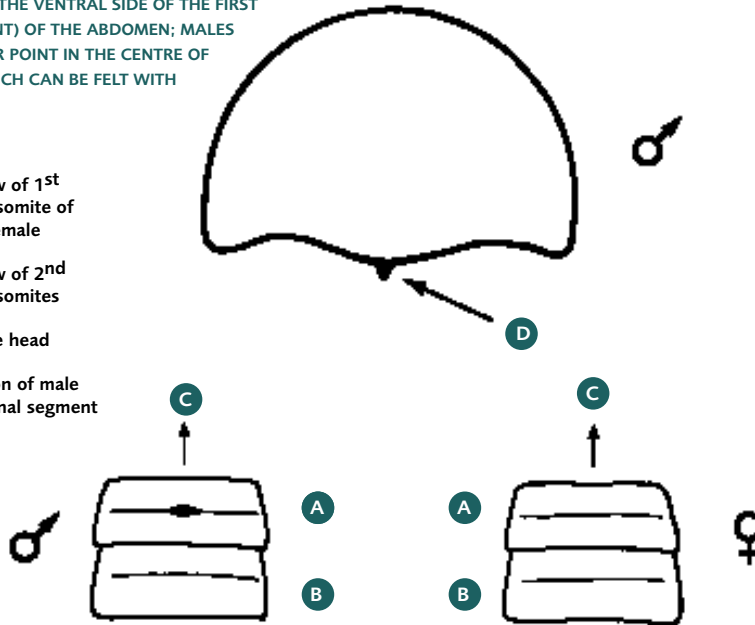

SOURCE: EMANUELA D'ANTONI, AFTER MARIO PEDINI

to younger juveniles, the prawns are much older. The third type of males are known as orange claw males (OC). OC males have golden coloured claws, which are 30 to 70% shorter than the claws of BC males. The three major types of males can generally be distinguished by sight. However, more reliable ways of determining which type males are can be found in Karplus, Malecha and Sagi (2000). As mentioned, a number of intermediate male forms have also been recognized, including weak orange claw (WOC), strong orange claw

(SOC) and transforming orange claw (TOC) males. The relationship and transformation of these various male types, and their importance in size management is covered later in this manual (Annex 8).

Many people find it hard to distinguish between *Macrobrachium* and penaeid (marine) shrimp, once they have been harvested and the heads have been removed. If the 'tail' still retains its shell there are, in fact, two easy ways of distinguishing them (Fincham and Wickins, 1976). Firstly,

**Figure 4**  
Notice that the abdominal pleura of the two females with this BC male *Macrobrachium rosenbergii* are enlarged to accommodate eggs (Brazil)



SOURCE: EUDES CORREIA

**Figure 5**  
The major male morphotypes of *Macrobrachium rosenbergii* are called blue claw (BC), orange claw (OC), and small male (SM) (Israel)

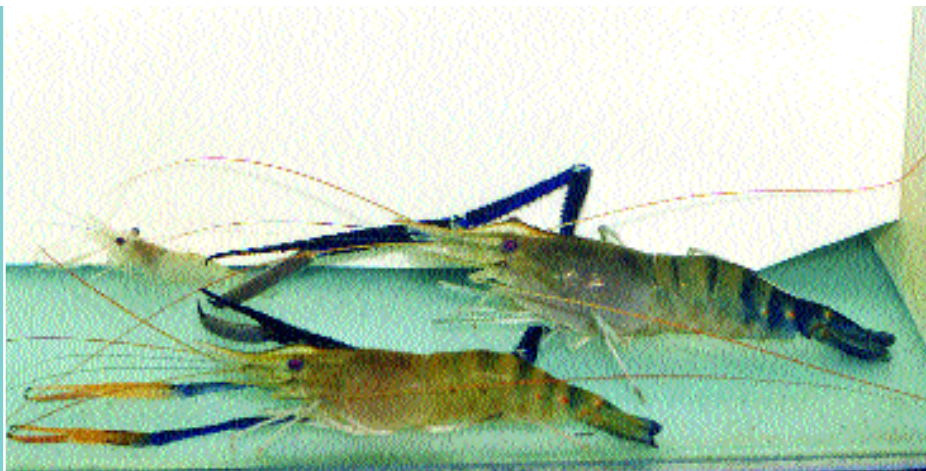

**SOURCE:** ASSAF BARKI, REPRODUCED FROM NEW AND VALENTI (2000) WITH PERMISSION FROM BLACKWELL SCIENCE

*Macrobrachium* spp., have a smooth rounded dorsal surface to the abdomen while penaeids have a simple or complex ridge at the dorsal apex of the abdomen (Figure 6). Secondly, the second pleuron of the abdomen (or tail) of *Macrobrachium* (in common with all caridean prawns, including some marine shrimp such as *Crangon* spp., *Pandalus* spp., and *Palaemon* spp.) overlaps both the first and the third pleuron. In penaeids the second pleuron overlaps the third pleuron only and is itself overlapped by the first (Figure 7).

### 1.3 Life history

All freshwater prawns (like other crustaceans) have to regularly cast their 'exoskeleton' or shell in order to grow. This process is referred to as moulting and is accompanied by a sud-

## FIGURE 6

The body shape of freshwater prawns (*Macrobrachium rosenbergii*) is different to that of penaeid shrimp, as these cross sections of the 5<sup>th</sup> abdominal segments show

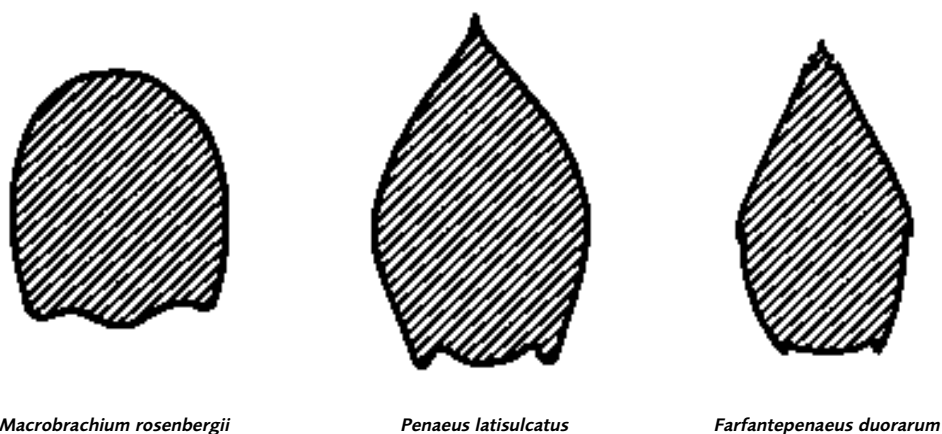

**SOURCE:** EMANUELA D'ANTONI, AFTER FINCHAM AND WICKINS (1976)

Freshwater (caridean) prawns can also be distinguished from penaeid shrimp by looking at the second pleura on the abdomen (see arrow)

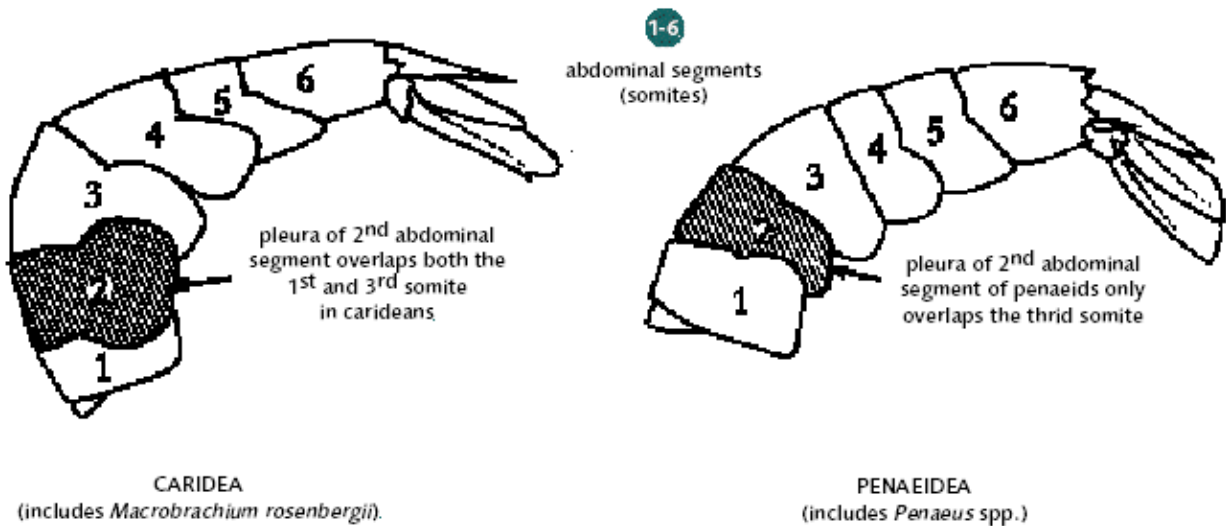

SOURCE: EMANUELA D'ANTONI, AFTER FINCHAM AND WICKINS (1976)

den increase in size and weight. There are four distinct phases in the life cycle of the freshwater prawn, namely eggs, larvae, postlarvae (PL) and adults. The time spent by each species of *Macrobrachium* in the different phases of its life cycle (and its growth rate and maximum size) varies, not only specifically but according to environmental conditions, mainly temperature.

The life cycle of *M. rosenbergii* can be summarized as follows. The mating (copulation) of adults results in the deposition of a gelatinous mass of semen (referred to as a spermatophore) on the underside of the thoracic region of the female's body (between the walking legs). Successful mating can only take place between ripe females, which have just completed their pre-mating moult (usually at night) and are therefore soft-shelled, and hard-shelled males. All of the various types of males are capable of fertilising females but their behaviour is different (see Annex 8). Detailed descriptions of the mating process are given in Ismael and New (2000) and Karplus, Malecha and Sagi (2000). Under natural conditions, mating occurs throughout the year, although there are sometimes peaks of activity related to environmental conditions. In tropical areas these coincide with the onset of the rainy season, whereas in temperate areas they occur in the summer.

Within a few hours of copulation, eggs are extruded through the gonopores and guided by the ovipositing setae (stiff hairs), which are at the base of the walking legs, into the brood chamber. During this process the eggs are fertilized by the semen attached to the exterior of the female's body. The eggs are held in the brood chamber (stuck to the ovigerous setae) and kept aerated by vigorous movements of the swimmerets. This is in contrast to penaeid shrimp, whose fertilized eggs are released into the sea, where they hatch. The length of time that the eggs are carried by female freshwater prawns varies but is not normally longer than three weeks. The number of eggs which are laid depends also on the size of the female. Female prawns of *M. rosenbergii* are reported to lay from 80 000 to 100 000 eggs during one spawning when fully mature. However, their first broods, (i.e. those which are produced within their first year of life), are often not more than 5 000 to 20 000. Females normally become mature when they reach 15-20 g but berried females have been observed as small as 6.5 g (Daniels, Cavalli and Smullen 2000). Under laboratory condi-



tions, where a breeding stock of both males and females was kept, it has been noted that egg incubation time averaged 20 days at 28°C (range 18-23 days). Ovaries frequently ripened again while females were carrying eggs. Pre-mate intermoult were separated by as little as 23 days (i.e. females on some occasions hatched two batches of eggs within a one-month period). It is unlikely that this would happen under natural conditions but it does show the potential fecundity of the animal.

As the eggs hatch, a process which is normally completed for the whole brood within one or two nights, the larvae (free-swimming zoeae) are dispersed by rapid movements of the abdominal appendages of the parent. Freshwater prawn larvae are planktonic and swim actively tail first, ventral side uppermost (i.e. upside down). *M. rosenbergii* larvae require brackishwater for survival. Those which hatch in freshwater will die unless they reach brackishwater within a few days. There are a number of microscopically distinct stages during the larval life of freshwater prawns, which lasts several weeks (Annex 1). Individual larvae of *M. rosenbergii* have been observed, in hatchery conditions, to complete their larval life in as little as 16 days but reaching this stage may take much longer, depending on water temperature and other factors. The importance of this observation is fully discussed later in the manual. Larvae eat continuously and, in nature, their diet is principally zooplankton (mainly minute crustaceans), very small worms, and the larval stages of other aquatic invertebrates.

On completion of their larval life, freshwater prawns metamorphose into postlarvae (PL). From this point onwards they resemble miniature adult prawns and become mainly crawling rather than free-swimming animals. When they do swim it is usually in a normal (dorsal side uppermost) way and in a forward direction. Rapid evasive movement is also achieved by contracting the abdominal muscles and rapid movement of the tail fan. Postlarvae exhibit good tolerance to a wide range of salinities, which is a characteristic of freshwater prawns.

Postlarvae begin to migrate upstream into freshwater conditions within one or two weeks after metamorphosis and are soon able to swim against rapidly flowing currents and to crawl over the stones at the shallow edges of rivers and in rapids. They can climb vertical surfaces and cross land, provided there is abundant moisture available. In addition to using the foods available to them as larvae, they now utilize larger pieces of organic material, both of animal and vegetable origin. Postlarval freshwater prawns are omnivorous and, as they grow, their natural diet eventually includes aquatic insects and their larvae, algae, nuts, grain, seeds, fruits, small molluscs and crustaceans, fish flesh and the offal of fish and other animals. They can also be cannibalistic. Further reading on this topic may be found in Ling (1969).

## 1.4 Sources of further biological information

---

The polymorphism of male prawns, which is particularly relevant to the management of prawn farming, is covered in Annex 8 of this manual. However, the internal morphology, reproductive physiology, and osmo-ionic regulation of freshwater prawns and the nature of ecdysis (moulting), autotomy (shedding of parts of the body) and the regeneration of appendages, are topics that are beyond the scope of this manual. New and Valenti (2000) have provided a review of these subjects.



# Site selection

**A STUDY OF THE POTENTIAL** market for the product and careful selection of suitable sites for prawn culture, whether it be for the larval (hatchery) or grow-out phases, is an essential prerequisite for successful farming. Failure to realize this before any project is commenced is likely to cause the ultimate downfall of the enterprise, which not only has unfortunate consequences for the farmer and investor(s) involved but may also cause serious damage to the image of prawn farming, both nationally and even internationally. Marketing is covered later in this manual.

The current section of the manual contains a brief description of the essential characteristics of good sites for freshwater prawn farming. More detailed information is available in a review by Muir and Lombardi (2000). You are also strongly recommended to obtain and study the FAO manuals on topography (FAO 1988, 1989b), soils (FAO 1985), and water (FAO 1981), as well as the section on site selection in FAO (1995)<sup>1</sup>.

## 2.1 Hatcheries and indoor nurseries

The site requirements for hatcheries and indoor nurseries, which are normally associated with each other, are similar. In this section of the manual, reference to hatcheries therefore includes indoor nurseries.

### NEEDS FOR GOOD QUALITY WATER

Although the larval stages of freshwater prawns require brackishwater for growth and survival, hatcheries do not have to be located on coastal sites. Prawn hatcheries can be sited on inland sites. There, the necessary brackishwater can be obtained by mixing locally available freshwater with seawater or brine (and sometimes artificial seawater) which has been transported to the site. Two decades ago, when the original FAO manual was written,

<sup>1</sup> These manuals are not specific to freshwater prawns. They are relevant to many forms of fish and crustacean farming and are designed for advanced extension workers.

most hatcheries operated on flow-through systems. Many still do so but the establishment of inland hatcheries, the costs of obtaining and transporting seawater or brine, and increasing concerns about the discharge of saline water in inland areas have encouraged some operators to minimize water consumption through partial or full recirculation systems. Inland hatcheries have the advantage that they can be sited wherever suitable freshwater is available and their market (namely outdoor nurseries and grow-out facilities) is close by. Where to site a hatchery is therefore not only a technical but also an economic consideration. This involves balancing the costs of transporting seawater and brine, or using recirculation, against the advantages of an inland site. Prawn hatcheries, regardless of type, require an abundant source of freshwater as well as seawater or brine. The quality of intake water, whether it be saline or fresh, is of paramount importance for efficient hatchery operation. Water quality is thus a critical factor in site selection. Hatchery sites should preferably be far from cities, harbours and industrial centres, or other activities which may pollute the water supply.

Due to the extra problems and dangers involved, it is generally recommended that freshwater prawn hatcheries should not be sited where the only source of water is surface water. However, this guidance has not always been observed. The minimum requirement during site evaluation should be to carry out watershed surveys and water analyses, especially for pesticides and oil spill residues. In coastal areas, it may be possible to draw good quality water from sub-surface layers, usually with freshwater overlying more saline water. The ideal site, where wells sunk to different depths provide both freshwater and seawater, is rare, although it is sometimes possible to make good use of groundwater sources, which are usually cleaner and less liable to become contaminated. The quality of water depends on the soil materials. In coastal areas with underlying coral rock, hatcheries can often get good quality seawater, free of pollution or harmful protozoa and bacteria. If sites with borehole seawater are not available, direct access to a sandy beach with mixed sand particle size can be selected. On this type of site a shallow beach filter of the type described in Annex 2 can be utilized. Muddy areas are not so suitable, but a larger filter may be used, provided it can be cleaned out periodically.

Many freshwater prawn hatcheries utilize surface supplies for both freshwater and seawater. Often, seawater can be drawn from areas where the salinity is 30 to 35 ppt, usually through a rigid pier off-take in the sea or a flexible buoyed system. Crude screening can be used to prevent the entry of the larger flora and fauna but this alone is not sufficient to protect the larvae from disease and parasitological problems. The use of unfiltered water will almost certainly result in disaster, so additional filtration is essential. Brine, sometimes used instead of seawater for inland hatcheries to minimize transport costs, can be obtained from salt evaporation pans. The brine, which is often between 80-100 ppt salinity but can be as high as 180 ppt, can be diluted with freshwater to form brackishwater (in theory, the higher the salinity of the brine used, the better; this is because the sudden osmotic shock which occurs when brine and freshwater are mixed together may reduce the numbers of bacteria and parasites present in the original supplies). Some hatcheries obtain freshwater pumped or fed by gravity from surface supplies such as rivers or irrigation canals. This practice exposes the hatchery to severe variations in water quality and particularly to water contamination from agricultural chemicals.

In all cases, water supplies need careful analysis during site selection, to determine their physical, chemical, and biological characteristics, and the extent to which these may vary daily, seasonally, or through other cycles. Special care is needed where hatcheries are situated in or near areas where the use of pesticides, herbicides, and fertilizers is intensive. Ideally, freshwater should be obtained from underground sources, though some of

these may be unsuitable because of high levels of iron and manganese, which are lethal to prawn larvae. Methods of reducing the levels of these ions are provided later in this section of the manual. City tap water is also normally suitable, provided it is vigorously aerated for 24-48 hours before use to remove residual chlorine, but may be too expensive to use. Well water should also be aerated, by cascading for example, to bring its dissolved oxygen level up to, or near to saturation point.

The brackishwater derived from the mixture of seawater, brine or artificial sea salts with freshwater for use in *M. rosenbergii* hatcheries should be 12-16 ppt, have a pH of 7.0 to 8.5, and contain a minimum dissolved oxygen level of 5 ppm. Water of various levels of salinity is also required for hatching *Artemia* as a larval food (Annex 4); the ideal hatching salinity depends on the source of cysts. The use of estuarine water, which would theoretically limit the need to balance freshwater and seawater to obtain the optimum salinity, is possible. However, the salinity of estuarine water varies, both diurnally and seasonally, making management difficult. In addition, although estuarine water can be utilized if its salinity is above the hatchery operating salinity, its use is not recommended because the levels of micro-organisms and potential pollution may be high.

Both freshwater and seawater must be free from heavy metals (from industrial sources), marine pollution, and herbicide and insecticide residues (from agricultural sources), as well as biological contamination (e.g. as indicated by the presence of faecal coliforms, which can be common in residential and agricultural areas). The analyses of water found suitable for use in freshwater prawn hatcheries are given in Table 2. Not much is known about the tolerance of larvae to toxic materials but it can be assumed that larvae are at least as (probably more) susceptible to pollution and toxicity as juveniles. As safe and lethal levels of specific substances are not yet fully understood, it is inappropriate to provide a summary of current research in this manual. Those who wish to know more about this topic are recommended to consult Boyd and Zimmermann (2000), Correia, Suwannatous and New (2000) and Daniels, Cavalli and Smullen (2000).

If seawater or freshwater is drawn from surface supplies, some form of treatment is essential, as discussed later in this manual. Both freshwater and seawater used for hatchery purposes should have a pH and a temperature as close as possible to the optimum range. Hydrogen sulphide and chlorine (e.g. from tap water) must be absent. High levels of nitrite and nitrate nitrogen must be avoided. Seawater should have as little diurnal or seasonal variation as possible. Very hard (reported as CaCO<sub>3</sub> level) freshwater should be avoided. The levels of iron (Fe) and manganese (Mn) should be low; copper (Cu) toxicity may also be a problem, especially after larval stage VI. However, some iron and manganese can be precipitated from well water by aeration; the resultant floc can be removed by sand filtration, or by biofiltration and settling (Box 1).

High levels of heavy metals, such as mercury (Hg), lead (Pb) and zinc (Zn), should also be avoided - these are most likely to be caused by industrial pollution. In general, especially where surface water is used, hatcheries should not be sited where their water supplies are endangered by pollution from tanker discharge, oil refineries, tanning, agricultural pesticides and herbicides, or chemical factories. In practice, an 'ideal' water supply might be difficult to define, but a summary of the characteristics of water found suitable for use in freshwater prawn hatcheries is provided in Table 2.

Artificial seawater has been used in some recirculation systems, especially in research. The stimulus for such work is that its use may reduce the problems caused by water pollution, parasites, and the presence of prawn competitors and predators in larval rearing tanks. Many formulations for artificial seawater exist and commercial preparations are sold in the aquarium trade. However, not all have been found suitable for fresh-

## Removal of iron and manganese

**W**ELL OR BOREHOLE water is often high in iron and manganese but low in dissolved oxygen (DO<sub>2</sub>). Aeration provides a source of DO<sub>2</sub>, which will convert iron and manganese from their ferrous and manganous forms to their insoluble oxidized ferric and manganic forms. 1 ppm iron (Fe) needs 0.14 ppm DO<sub>2</sub> for oxidation; 1 ppm of manganese (Mn) requires 0.27 ppm DO<sub>2</sub>. Thus, aeration provides a means of removing iron and manganese from water, since the insoluble precipitates formed by converting them to their insoluble forms can be settled or filtered out. Additionally, aeration also helps to strip out the volatile organic

compounds and the hydrogen sulphide (H<sub>2</sub>S) also found in this type of water source.

DO<sub>2</sub> should be supplied in an aeration tank, using fine bubble air diffusers. The water must spend at least 10 minutes under aeration (10 minutes residence time). The water should then be circulated through another tank containing biofiltration media. Once this filter has been developed (i.e. run for some time), the iron and manganese particles will tend to fall out of solution and accumulate on the surface of the biofiltration media. In large-scale systems the water is then passed through a pressure filter. However, passing it into a third (settling) tank, where

most of the rest of the Fe and Mn precipitates will settle out, should provide water sufficiently low in Fe and Mn for use in your hatchery. It is suggested that the water be allowed to remain in the settling tank for 24 hours before the water is pumped (without disturbing the sediment) into the hatchery for use.

Obviously, the biofiltration media will have to be regularly washed; placing the plastic media within stainless steel or plastic cages makes it easy to remove it from the filtration tank for this purpose. The settlement tank will also need to be cleaned out. The dimensions of the equipment you use depend on the quantity of water you need to treat.

**SOURCE:** FURTHER DETAILS ON FLOW-THROUGH SYSTEMS FOR STRIPPING WELL WATER AND OTHER TYPES OF WATER TREATMENT ARE AVAILABLE FROM WATER INDUSTRY SUPPLIERS. THIS BOX WAS DERIVED FROM A [WWW.GOOGLE.COM](http://WWW.GOOGLE.COM) LINK TO THE WEBSITE OF DRYDEN AQUA ([WWW.DRYDNAQUA.COM](http://WWW.DRYDNAQUA.COM)), WHICH IS GRATEFULLY ACKNOWLEDGED.

water prawns and many are complex and expensive. The exact and specific ionic composition that is optimum for freshwater prawns is not yet known. The formula for a simple preparation which has been used in *Macrobrachium rosenbergii* hatcheries is given in Table 3. This contains the essential ions sodium, potassium, chloride, bromide, carbonate and sulphate, together with the correct ratio of calcium and magnesium. This preparation may not be complete, and there is some evidence that its use increases oxygen consumption after larval stage V, but it (and variations of the formula) have been used in research and a few commercial cycles in Brazil. The unit cost, even for such a simple formula, is high (e.g. US\$ 75/m<sup>3</sup> in Brazil in 2000). However, not much is required because evaporative losses can be made up with freshwater alone and, if properly handled and processed, the same brackishwater can be used for two consecutive larval cycles without affecting production. The productivity of systems using artificial seawater is reported to be as high as 40 PL/L but the larval cycle may take about 10% longer than when natural seawater is used. Due to its cost and the uncertainty about its effectiveness, the use of artificial seawater is not recommended in this manual. Whenever possible, the use of natural seawater or brine is recommended.

## DECIDING HOW MUCH WATER IS NEEDED

The quantity of freshwater and seawater required for a freshwater prawn hatchery depends not only on the proposed scale of operation but also on the type of management utilized (flow-through, recirculation, use of brine). Flow-through systems obviously require the maximum quantities of water. All other systems will either require less seawater or, in the case of those which utilize brine or artificial seawater, none. It is therefore not possible in this manual to define the exact quantities of water needed, as these are scale, site and management system dependent. An example of the water requirements for a flow-through system using seawater that includes ten 5 m<sup>3</sup> larval tanks, each capable of producing 50 000 postlarval prawns (total 500 000 per larval cycle) within a maximum of 35 days, is provided in Box 2.

TABLE 2 Characteristics of water suitable for freshwater prawn hatcheries

VARIABLES	FRESHWATER (PPM)	SEAWATER (PPM)	BRACKISHWATER (PPM)
Total hardness (as CaCO <sub>3</sub> )	<120	-	2 325-2 715
Calcium (Ca)	12-24	390-450	175-195
Sodium (Na)	28-100	5 950-10 500	3 500-4 000
Potassium (K)	2-42	400-525	175-220
Magnesium (Mg)	10-27	1 250-1 345	460-540
Silicon (SiO <sub>2</sub> )	41-53	3-14	5-30
Iron (Fe)	<0.02	0.05-0.15	<0.03
Copper (Cu)	<0.02	<0.03	<0.06
Manganese (Mn)	<0.02	<0.4	<0.03
Zinc (Zn)	0.2-4.0	0.03-4.6	<3
Chromium (Cr)	<0.01	<0.005	<0.01
Lead (Pb)	<0.02	<0.03	<0.03
Chloride (Cl)	40-225	19 000-19 600	6 600-7 900
Chlorine (Cl <sub>2</sub> )	nil	-	nil
Sulphate (SO <sub>4</sub> )	3-8	-	-
Phosphate (PO <sub>4</sub> )	<0.2	-	-
Hydrogen sulphide (H <sub>2</sub> S)	nil	nil	nil
Total dissolved solids (TDS)	217	-	-
Turbidity (JTU)	nil	nil	nil
Dissolved oxygen (DO <sub>2</sub> )	>4	>5	>5
Free carbon dioxide (CO <sub>2</sub> )	nil	-	nil
Ammonia (NH <sub>3</sub> -N)	-	-	<0.1
Nitrite (NO <sub>2</sub> -N)	-	-	<0.1
Nitrate (NO <sub>3</sub> -N)	-	-	<20
pH	6.5-8.5 units	7.0-8.5 units	7.0-8.5 units
Temperature	-	-	28-31(°C)

NOTE: THE SIGN '-' MEANS 'NOT KNOWN' OR 'NO SPECIFIC RECOMMENDATION'.

SOURCE: DERIVED FROM NEW AND SINGHOLKA (1982), CORREIA, SUWANNATOUS AND NEW (2000) AND VALENTI AND DANIELS (2000)

TABLE 3 Artificial brackishwater (12 ppt) for *M. rosenbergii* hatcheries

SALT	QUANTITY (G/M <sup>3</sup> )
Sodium chloride (NaCl)	9 200
Magnesium sulphate (MgSO <sub>4</sub> .7H <sub>2</sub> O)	2 300
Magnesium chloride (MgCl <sub>2</sub> .6H <sub>2</sub> O)	1 800
Calcium chloride (CaCl <sub>2</sub> .H <sub>2</sub> O)	467
Potassium chloride (KCl)	200
Sodium bicarbonate (NaHCO <sub>3</sub> )	67
Potassium bromide (KBr)	9

**NOTE:** WEIGH AND DILUTE THE SALTS INDIVIDUALLY WITH PREVIOUSLY FILTERED FRESHWATER. ADD THE RESULTING SOLUTIONS TO A TANK IN THE ORDER SHOWN ABOVE, AND MIX THOROUGHLY USING A PVC STIRRER. THEN ADD FRESHWATER UNTIL THE SALINITY IS REDUCED TO 12 PPT. MAINTAIN THE FINAL SOLUTION UNDER STRONG AERATION FOR 24 HOURS AND ADJUST THE SALINITY AGAIN TO 12 PPT, IF NECESSARY, BEFORE TRANSFER TO THE RECIRCULATION SYSTEM.

**SOURCE:** VALENTI AND DANIELS (2000)

### OTHER REQUIREMENTS FOR HATCHERY SITES

In addition to having sufficient supplies of good quality water, a good hatchery site should also:

- have a secure power supply which is not subject to lengthy power failures. An on-site emergency generator is essential for any hatchery - this should be sized so that it has the output necessary to ensure that the most critical components of the hatchery (e.g. aeration, water flow), can continue to function;
- have good all-weather road access for incoming materials and outgoing PL;
- be on a plot of land with an area appropriate to the scale of the hatchery, that has access to the quantity of seawater and freshwater supplies required without excessive pumping. The cost of pumping water to a site elevated high above sea level, for example, may be an important factor in the economics of the project;
- not be close to cities, harbours, mines and industrial centres, or to other activities that may pollute the water supply;
- be situated in a climate which will maintain water in the optimum range of 28-31°C, without costly environmental manipulation;
- have access to food supplies for larvae;
- employ a high level of technical and managerial skills;
- have access to professional biological assistance from government or other sources;
- have its own indoor/outdoor nursery facilities, or be close to other nursery facilities; and
- be as close as possible to the market for its PL. In the extreme case, it should not more than 16 hours total transport time from the furthest farm it will be supplying.

## 2.2 Outdoor nurseries and grow-out facilities

The success of any nursery facility or grow-out farm depends on its access to good markets for its output. Its products may be sold to other farms (in the case of nurseries), directly to the public, to local markets and catering facilities, or to processors or exporters. The needs and potential of each type of market need to be considered. For example, more income may result if you can sell your market-sized prawns alive. The scale, nature and locality of the

## Flow-through requirements for ten 5 m<sup>3</sup> larval rearing tanks

**I**N A FLOW-THROUGH system, the salinity of the seawater or brine available controls the amount of freshwater necessary to produce the 12 ppt brackishwater needed for larval rearing (Table 4). The daily consumption of 12 ppt water for a single 5 m<sup>3</sup> rearing tank in a flow-through system exchanging approximately 50% of the water per day would be 2.5 m<sup>3</sup> (2 500 L). However, emergencies sometimes occur, when it is necessary to rapidly change all the water in a tank. Pumping capacity must be sufficient to fill any tank with brackishwater within one hour in order to make the daily water exchange as rapid as possible. Thus, in this example, the pumping and pipe work capacity must be sufficient to supply a peak demand of 5 m<sup>3</sup> within an hour (approximately 83 L/min) to each

tank. For a complete larval cycle, allowing for some additional exchange to solve rearing water quality problems and assuming that the cycle lasts 35 days, a total of around 90 m<sup>3</sup> of 12 ppt water would be consumed for every 50 000 PL produced. This is equivalent to about 2.6 m<sup>3</sup>/day for each larval tank, or 25.7 m<sup>3</sup> for ten tanks. Rounding up, and allowing an additional safety margin, a hatchery with ten tanks of this size would need about 30 m<sup>3</sup> of brackishwater per day.

Assuming a steady intake salinity of 30 ppt (and referring to Table 4), the requirement would be  $30 \div 10 \times 4 = 12 \text{ m}^3$  of seawater per day. The need for the larval tanks would be  $30 \div 10 \times 6 = 18 \text{ m}^3$  of freshwater per day.

In addition, sufficient freshwater to maintain holding tanks for PL must

be provided. For a hatchery operating ten 5 m<sup>3</sup> larval tanks, facilities for providing an average of 20 m<sup>3</sup>/day of additional freshwater (based on a PL stocking density of 5 000 PL/m<sup>2</sup> and an average water exchange rate of 20%/day:  $500\,000 \div 5\,000 \times 20 \div 100$ ) will be needed during the periods when postlarval holding tanks are being operated. [Note: much larger quantities of freshwater will be needed if the PL are held for more than one week, because stocking densities will have to be reduced]

The total water consumption for a hatchery operating ten 5 m<sup>3</sup> tanks producing 500 000 PL in each larval cycle and selling the PL within one week after metamorphosis would therefore be 12 m<sup>3</sup> of seawater and 18 + 20 = 38 m<sup>3</sup> of freshwater per day.

market is the first topic that you should consider and the results of your evaluation will determine whether the site is satisfactory and, if so, the way in which the farm should be designed and operated. Despite the obvious importance of the market, it is surprising how often that this topic is the last criterion to be investigated. It is considered in more detail later in this manual.

It also important to consider other factors to ensure success, including the:

- suitability of the climatic conditions;
- suitability of the topography;
- availability of adequate supplies of good quality water;
- availability of suitable soil for pond construction;
- maximum protection from agricultural and industrial pollution;
- availability of adequate physical access to the site for the provision of supplies and the movement of harvested animals;
- availability of supplies of other necessary inputs, including postlarval and/or juvenile prawns, equipment, aquafeeds or feed ingredients, and power supplies;
- availability of good skilled (managerial) and unskilled labour;



TABLE

## 4 Diluting seawater and brine to make brackishwater for larval freshwater prawn culture

SALINITY OF SEAWATER OR BRINE (PPT)	AMOUNTS OF WATER REQUIRED TO MAKE 10 M <sup>3</sup> OF 12 PPT BRACKISHWATER	
	FRESHWATER (M <sup>3</sup> )	SEAWATER (M <sup>3</sup> )
180	9.334	0.666
144	9.167	0.833
108	8.889	1.111
72	8.334	1.666
36	6.667	3.333
35	6.571	3.429
34	6.471	3.529
33	6.364	3.636
32	6.250	3.750
31	6.129	3.871
30	6.000	4.000
29	5.862	4.138
28	5.714	4.286
27	5.556	4.444
26	5.385	4.615
25	5.200	4.800
24	5.000	5.000

NOTE: INCOMING FRESHWATER IS ASSUMED TO BE ZERO SALINITY.

- presence of favourable legislation; and
- availability of adequate investment.

These topics have been discussed in detail in many FAO and other publications, including FAO (1981, 1988, 1989b 1995) and Muir and Lombardi (2000). This section of the manual concentrates on those factors which are particularly important or specific to freshwater prawn farming.

### CHOOSING YOUR SITE: TOPOGRAPHY AND ACCESS

Farms must be close to their market so the road access must be good. Large farms will need to have local access for heavy trucks be able to reach the farm easily, for the delivery of supplies and the efficient collection of harvested prawns.

A survey is necessary, to assess the suitability of a site from a topographical point of view. This will include transects, to evaluate slope and to determine the most economic ways of constructing ponds and moving earth. It is important to minimize the quantities of earth to be shifted during pond construction. Flat or slightly sloping lands are the most satisfactory. The ideal site, which slopes close to 2% (2 m in 100 m), allows good savings on earth movement. In addition, ponds constructed on this type of site can be gravity filled (either naturally or by the creation of a dam) and gravity drained. Where potential farm sites are steeper, or if gradients are irregular, care should be taken to ensure that pond sizes and alignments allow efficient construction, and at the same time permit good access and effective water supply and drainage.

The ideal site is rarely available, however. Many successful farms exist where the only feasible method to fill and drain the ponds is by pumping. Some sites, where ponds

are excavated in flat, often seasonally flooded areas, may require higher pond banks for flood protection. Prawn farming may be practised in rain-fed ponds but their productivity may be low. The level of productivity in grow-out ponds is governed by complex management factors, which are dealt with later in this manual. The cost of filling and draining ponds, which depend on the characteristics of the site, must be carefully assessed before the site is chosen.

## CHOOSING YOUR SITE: CLIMATE

This is another fundamentally important issue. You should study the meteorological records to determine temperature, the amount and seasonality of rainfall, evaporation, sunlight, wind speed and direction, and relative humidity. Avoid highly unstable meteorological regions. Strong storms and winds increase the risks of flood and erosion damage, and may lead to problems with transport access and power supply. As far as possible, do not site the farm in an area which is subjected to severe periodic natural catastrophes, such as floods, typhoons, landslips, etc. If you decide to site your farm in an area subject to floods, you will need to make sure that the banks of individual ponds are higher than the highest known water level at that site, or you will need to protect the whole farm with a peripheral bank.

Temperature is a key factor. Seasonal production is possible in semi-tropical zones where the monthly average air temperature remains above 20°C for at least seven months of the year. This occurs, for example, in China and some southern States of continental USA. For successful year-round farming, sites with large diurnal and seasonal fluctuations should be avoided. The optimum temperature range for year-round production is between 25 and 31°C, with the best results achievable if the water temperature is between 28 and 31°C. The temperature of the rearing water is governed not only by the air and ground temperature but by solar warming and the cooling effects of wind and evaporation. The rate by which pond water is exchanged and the temperature of the incoming water are also important considerations.

Rainfall, evaporation rates, relative air humidity and wind speed and direction also need to be investigated. Ideally, evaporation losses should be equal to or slightly lower than rainfall input, to maintain an approximate water balance. However, in some locations this balance changes seasonally. There may be cooler high-rainfall periods during which water can be stored in deeper ponds, and hotter high-evaporation periods in which water supplies decrease. In these areas, it is still possible for you to produce one or more crops by adjusting production plans. Mild winds are useful to promote gas exchange (oxygenation) between water and the atmosphere. However, strong winds can increase water losses by evaporation and may also generate wave action, causing erosion of the pond banks. Avoid areas where it is constantly cloudy because this makes it hard to maintain a steady water temperature, as it interferes with solar penetration. Periods of cloud cover of several days' duration may also cause algal blooms to crash, which in turn lead to oxygen depletion.

Apart from the dangers of water-supply contamination, you should not site your farm in an area where the ponds themselves are likely to be affected by aerial drift of agricultural sprays; prevailing wind direction should therefore be taken into account. Constructing ponds adjacent to areas where aerial application of herbicides or pesticides is practised is also undesirable. Freshwater prawns, like other crustaceans, are especially susceptible to insecticides.

## CHOOSING YOUR SITE: WATER QUALITY AND SUPPLY

Freshwater is normally used for rearing freshwater prawns from postlarvae to market size. Prawns will tolerate partially saline water (reports indicate that they have been experi-

mentally cultured at up to 10 ppt; however, they do not grow so well at this salinity). You could rear *Macrobrachium rosenbergii* in water which may be too saline to be drinkable or useful for irrigation. Water of 3-4 ppt salinity may be acceptable for the culture of *M. rosenbergii*, but do not expect to achieve results as good as those obtainable in freshwater.

The reliability of the quality and quantity of the water available at the site is a critical factor in site choice. However, as in the case of hatchery water supplies, the absolute 'ideal' for rearing sites may be difficult to define; a range of water qualities may be generally suitable. As for hatchery water, the level of calcium in the freshwater seems to be important. Growth rate has been reported to be lower in hard than in soft water. It is recommended that freshwater prawn farming should not be attempted where the water supply has a total hardness of more than 150 mg/L (CaCO<sub>3</sub>). Table 5 provides some criteria for

TABLE 5 | Water quality requirements for freshwater prawn nursery and grow-out facilities

PARAMETER	RECOMMENDED (IDEAL) RANGE FOR FRESHWATER PRAWNS	LEVELS KNOWN TO BE LETHAL (L) OR STRESSFUL (S) TO JUVENILE PRAWNS	LEVELS OBSERVED IN EXISTING PRAWN FARMS IN BRAZIL IN 1998
Temperature (°C)	28-31	<12 (L) <19 (S) >35 (L)	-
pH (units)	7.0-8.5	>9.5 (S)	5.5-8.3
Dissolved oxygen (ppm DO <sub>2</sub> )	3-7	2 (S) 1 (L)	-
Salinity (ppt)	<10	-	-
Transparency (cm)	25-40	-	-
Alkalinity (ppm CaCO <sub>3</sub> )	20-60	-	7-102
Total hardness (ppm CaCO <sub>3</sub> )	30-150	-	10-75
Non-ionized ammonia (ppm NH <sub>3</sub> -N)	<0.3	>0.5 at pH 9.5 (S) >1.0 at pH 9.0 (S) >2.0 at pH 8.5 (S)	0.1-0.5
Nitrite nitrogen (ppm NO <sub>2</sub> -N)	<2.0	-	0.1-1.7
Nitrate nitrogen (ppm NO <sub>3</sub> -N)	<10	-	-
Calcium (ppm Ca)	-	-	0.01-18.6
Magnesium (ppm Mg)	-	-	0.01-6.8
Total phosphorus (ppm P)	-	-	0.003-4.4
Sodium (ppm Na)	-	-	0.26-30.0
Potassium (ppm K)	-	-	0.01-4.9
Sulphate (ppm SO <sub>4</sub> )	-	-	0.1-26.0
Boron (ppm B)	<0.75	-	0.04-0.74
Iron (ppm Fe)	<1.00	-	0.02-6.00
Copper (ppm Cu)	<0.02	-	0.02-0.13
Manganese (ppm Mn)	<0.10	-	0.01-0.31
Zinc (ppm Zn)	<0.20	-	0.01-0.20
Hydrogen sulphide (ppm H <sub>2</sub> S)	nil	-	-

NOTE: THE SIGN '-' MEANS 'NOT KNOWN' OR 'NO SPECIFIC RECOMMENDATION'.

SOURCE: MODIFIED FROM BOYD AND ZIMMERMANN (2000)

water supplies for freshwater prawn nursery and grow-out facilities. The water supply must be free from pollution, particularly agricultural chemicals. Prawn performance is likely to be adversely affected long before lethal levels are reached. However, the exact lethality of various chemicals is still being researched and it is not appropriate to list safe levels in this manual. Those who wish to examine the status of this research may wish to consult Boyd and Zimmermann (2000), Correia, Suwannatous and New (2000) and Daniels, Cavalli and Smullen (2000).

As with hatcheries, the water must also be as predator-free as possible, though standards need not be quite so high. This may be achieved by screening (Figures 8a, 8b and 8c) or by the use of well water. Underground water, because of its chemical and microbiologi-

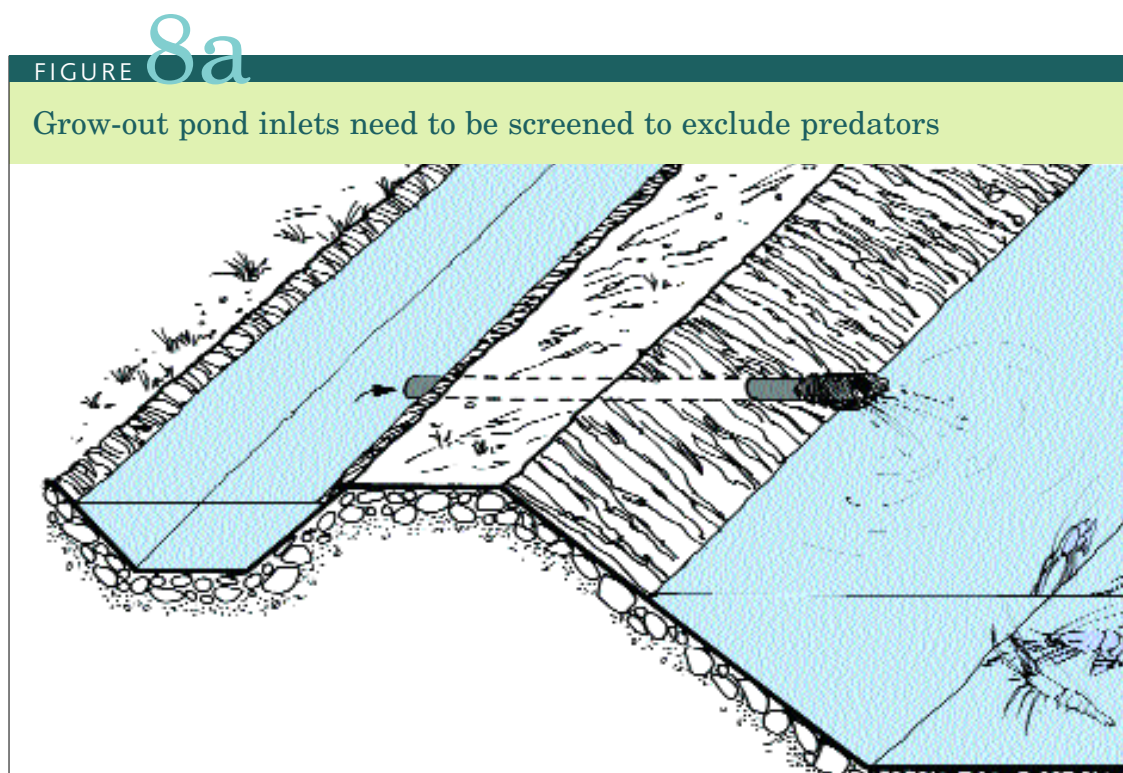

SOURCE: EMANUELA D'ANTONI

**Figure 8b**  
Screened inlets being used in this freshwater prawn grow-out pond (Peru)



SOURCE: OSCAR ORBEGOSO MONTALVA

**Figure 8c**  
This type of inlet screen is used in Thailand, especially when ponds are filled by long-tail pump



SOURCE: HASSANAI KONGKEO

cal quality and its lack of predators, is undoubtedly the preferred water source. In practice, sites that only have access to surface water supplies (rivers, lakes, reservoirs, irrigation canals, etc.) are the most commonly used. However, you must be aware of the extra risk that their use brings. Screening the water supply helps to reduce the initial entry of predators but cannot clean up chemically polluted water or water containing disease organisms. You should consider the location of other existing or planned freshwater prawn farms. You can then make an assessment of the risk that the water supplies of the new farm may be contaminated by the effluent from other farms. If you are going to use surface water, constructing your farms close to a waterfall bringing water from a remote and unpolluted watershed or below the dam of a reservoir (though such water, if drawn from the epilimnion, may initially be high in hydrogen sulphide) would be ideal.

The minimum farm size for economic viability depends on several other factors but the quantity and continuity of the available water supply sets an absolute technical limit on the pond area of your farm, and on its potential productivity. Water is required for four major purposes, namely filling ponds, compensating losses from seepage and evaporation, water exchange, and emergency flushing. When determining the amount of water available on a specific site for freshwater prawn farming you should take the rainfall pattern into account. This may be sufficient to replace or exceed evaporative and seepage losses, at least at some time during the year. An example of grow-out water requirements is provided in Box 3.

In addition to having enough water to fill the ponds it is, at the very minimum, necessary to have enough water available throughout the growing period to replace evaporative and seepage losses. Evaporative losses depend on solar radiation and wind and relative humidity and are therefore governed by the climatic features of the site. Seepage losses depend on the soil characteristics of the farm area, mainly its permeability. Seepage losses may be small where the water table is high or where the water level of the pond is the same as in adjoining fields (e.g. in a paddy field area). However, in other cases, particularly where pond construction is poor, seepage losses can be very great. The quantity of water necessary for this purpose must be assessed locally and the cost of providing it is an

### BOX 3

## Grow-out water requirements

**T** **O FILL** A 0.2 ha pond with an average water depth of 0.9 m requires  $10\,000 \times 0.2 \times 0.9 = 1\,800 \text{ m}^3$  of water. Since it is usually desirable to be able to fill the pond within 12 hours, it follows that it must be possible to extract up to  $1\,800 \div 12 \div 60 = 2.5 \text{ m}^3$  (2 500 L) per minute from the water source for this

pond. Normally it is only necessary to completely fill a drained pond after a rearing cycle is completed and the pond has been drained and treated, that is, once every 6-11 months.

There will also be times when, because of poor pond water quality, you may find it necessary to flush the pond and replace a substantial pro-

portion of the water while prawns are growing in it. However, it is very unlikely that it will be necessary for you to fill more than one pond at the same time, if you have a small farm. Thus, for example, five 0.2 ha ponds would therefore not require a maximum water supply five times larger than one 0.2 ha pond.

important economic factor. As ponds mature, ponds tend to ‘seal’ themselves, through the accumulation of detritus and algal growth, thus limiting seepage losses. Seepage losses can also be minimized by a number of techniques, including sealing the ponds with organic matter, puddling, compaction, laying out a ‘soil blanket’, applying bentonite, or lining them with polyethylene, PVC, or butyl rubber sheeting. Details of these procedures are provided in another FAO publication (FAO 1996).

There is no substitute for the site-specific determination of the water requirements for your farm but an example of water consumption needs for different sized farms, using a number of assumptions is given in Table 6. Techniques for measuring water resources are given in books on hydrology and agricultural water assessment such as ILACO (1981). Methods for estimating seepage and evaporation losses and calculating water requirements are given in FAO (1981). Large-scale farms may wish to consult specialist contractors.

TABLE 6 | Example of water requirements for ponds based on various assumptions

TOTAL FARM WATER SURFACE AREA <sup>2</sup> (HA)	QUANTITY OF WATER REQUIRED (m <sup>3</sup> /MIN)		
	FILLING PONDS <sup>3</sup>	REPLACING SEEPAGE AND EVAPORATION LOSSES <sup>4</sup>	AVERAGE CONSUMPTION <sup>5</sup>
0.2	2.50	0.041	0.048
0.5	2.50	0.103	0.120
1.0	2.50	0.205	0.239
2.0	2.50	0.410	0.478
3.0	3.75	0.615	0.718
5.0	6.25	1.025	1.196
10.0	12.50	2.050	2.392
20.0	25.00	4.100	4.785
40.0	50.00	8.200	9.570

A supply of drinking water and waste disposal facilities are an added advantage to a freshwater prawn farm site but are not absolutely essential. Provision can be made on-site, for example by obtaining batch supplies of drinking water, sinking a borehole, or collecting and filtering rainwater. However, if ice is going to be made, or prawns are to be processed and packed on site, a supply of high quality water, normally the equivalent of drinking (potable) water, is essential. Aqueous waste disposal from such activities can be routed to a septic tank, a waste lagoon, or a simple soak-away.

2 Assumes an average water depth of 0.9 m

3 For filling ponds at the beginning and on future occasions. Assumes that the unit pond size is 0.2 ha and that the pond can be filled within 12 hours. Also assumes that it will never be necessary to fill more than one pond (or 10% of the pond surface area, whichever is the greater) at the same time. Local experience will tell if this allowance is either not enough or too generous.

4 Assumes average seepage losses of 10 mm/day, which is typical for a clayey loam which has not been puddled (FAO, 1981), 500 mm/yr evaporation (this is extremely site-specific) and 2% water exchange per day. This is equivalent to 100 m<sup>3</sup>/ha/day (approximately 0.07 m<sup>3</sup>/ha/min) for seepage, approximately 13.7 m<sup>3</sup>/ha/day (0.01 m<sup>3</sup>/ha/min) for evaporation, and 180 m<sup>3</sup>/ha/day (0.125 m<sup>3</sup>/ha/min) for water exchange in ponds with an average depth of 0.9 m. Total maintenance requirements are therefore 0.205 m<sup>3</sup>/ha/min.

5 This combines the maintenance rate with the quantity necessary to fill all ponds twice per year, averaged out to a volume per minute consumption basis.

## CHOOSING YOUR SITE: SOIL CHARACTERISTICS

There must be enough soil available for pond construction, whether the ponds are to be excavated or pond banks are to be erected above ground. Unless good information about the soil characteristics is already available, site assessments should include taking a suitable number of soil cores up to 1 m deeper than the expected pond depth. These must be analysed for their soil classification and chemistry. If rocks, boulders and tree stumps are present, you must consider the cost of their removal (to make the pond bottoms flat and for constructing impervious pond banks) while you are assessing the economic feasibility of the farm. Flooded and saturated areas are difficult to construct ponds in, and the expenses of doing so must be taken into consideration. Construction of concrete pond structures (e.g. pond outlets) is difficult in soils with a high salt content. Preferably, the site should have a shape which allows you to construct regular-shaped ponds. Irregular-shaped ponds are difficult to manage; rectangular ponds are more efficient to operate.

Although supplemental food is given to freshwater prawns reared in earthen ponds, a considerable amount of their food intake is from natural sources. It is therefore preferable to site the farm where the soil is fertile, as this will reduce the need and costs of fertilisation. Since a water pH of 7.0-8.5 is required for successful freshwater prawn culture, it is preferable not to build the farm on potentially acid sulphate soils. These soils have pH values of 4.5 or less, together with high concentrations of soluble iron, manganese and aluminium. Most people associate the occurrence of acid sulphate soils with mangrove areas but they also occur far away from such areas. Aquaculture ponds are frequently constructed on such soils, despite their poor suitability. However, their production levels are often too low, or the costs of liming and fertilisation are too high, for them to be financially viable.

Freshwater prawn ponds should be constructed on soil which has good water retention characteristics or where suitable materials can be economically brought onto the site to improve water retention. The water retention characteristics of soil are highly site-specific and prospective farmers must seek the professional advice of soil engineers and fishery officials from local government departments, such as the Ministry of Agriculture and the Public Works Department. If there are other fish farms or irrigation reservoirs in the area, you should ask the neighbouring farmers for advice, based on their specific local experience. Pervious soils, which are very sandy or consist of a mixture of gravel and sand, are unsuitable unless the water table is high and surrounding areas are always waterlogged. Soils which consist of silt or clay, or a mixture of these with a small proportion of sand, normally have good water retention characteristics. Peaty soils are not suitable. The clay content should not exceed 60%; higher clay content soils swell when moist and crack during the dry season, thus making repairs necessary. Methods for the preliminary assessment of particle sizes, permeability and plasticity (how well soils will compact to their optimum strength and permeability) are given in FAO (1985).

## CHOOSING YOUR SITE: POWER SUPPLIES

A source of electricity is desirable but not essential. A variety of power sources may be used for supplying the energy necessary for water movement on the farm including:

- water power itself (gravity and current flow);
- wind;
- electricity;
- petrol and diesel fuel; and
- wood.

Electricity is desirable, although it need not be the sole source of energy, for powering lights, wells and feed-making equipment. The most suitable power source to use is entirely site-specific and depends upon such factors as equipment availability, unit power costs and the characteristics of the site and its water supply. Generating electricity on the farm may be cheaper than running a new supply from the nearest point on the national power grid. Where a power failure would quickly result in severe losses, for example in farms operating highly intensive systems dependent on aeration, a back-up power source (usually a diesel generator) is essential.

The ideal would be for you to be able to move water within your site by gravity but this depends on the nature of the site. In practice, most farms use electric or fuel-driven pumps for supplying water to the ponds (Figure 9) and some also use them for draining the ponds during harvesting (Figure 10). Some small farms prepare cooked feed using wood as a fuel source, while others utilize the time-old methods of wind and water power for transporting water. Windmills and water-wheels can also be used to pump water for filling ponds, or to generate a farm supply of electricity.

**Figure 9**  
Pumps can be powered by old diesel bus engines (Thailand)



SOURCE: HASSANAI KONGKEO

**Figure 10**  
More expensive pumps are used in some countries; this one is being used to harvest freshwater prawns (Hawaii)



SOURCE: SPENCER MALECHA

## CHOOSING YOUR SITE: FRY AND CONSUMABLES

There is no fundamental technical difficulty in transporting postlarval freshwater prawns long distances by road, rail or even air. However, you need provide vehicle access close to the pond site. It is not satisfactory to bring PL long distances to your grow-out site if there are going to be further delays due to poor local access. In selecting the site of your farm, it is important to assess the cost of obtaining PL. Transport costs can add enormously to basic stocking costs. Also, PL prices themselves tend to rise as the distance between the farm and the nearest hatchery increases (because there is less competition between hatchery operators).

Also, you need to consider the availability and cost of getting feeds to your potential farm site. A large farm (say 40 ha) which achieves an average output of 2 500 kg/ha/yr, for example, would require an average of about 5 mt of dry feed per week. Supposing that this feed is delivered to the site monthly, it would arrive in 20 mt batches; this means you need good vehicle access to the site. You would also need to provide clean, dry, cool, and secure feed storage facilities on the site. Similar factors apply to the supply of other consumables,



such as fertilizers and equipment. Smaller farms, of course, do not have such sophisticated requirements. However, these factors are still important, especially the availability of good storage facilities.

### CHOOSING YOUR SITE: LABOUR

Small freshwater prawn farms can be successfully maintained by unskilled labour but outside assistance from community (e.g. cooperative groups of farmers) and commercial sources (hatchery operators, feed suppliers, etc.), is necessary at times of stocking or harvesting. Larger farms require a competent, on-site manager. The amount of labour utilized on freshwater prawn farms varies considerably. For example, it is estimated that a 40 ha farm needs two senior staff and six labourers. At the other extreme, one person should be able to take care of normal maintenance, including feeding but excluding harvesting, of a 1-2 ha freshwater prawn farm. Often this type of farm is family owned and operated.

### CHOOSING YOUR SITE: SYMPATHETIC AUTHORITIES AND TECHNICAL ASSISTANCE

You should consider many other factors in selecting your farm site. These include the local and national government regulations concerning water usage and discharge, land use, movement of live animals, import of non-indigenous stocks (where *M. rosenbergii* is not already present), disease monitoring, taxation, etc. In most countries where freshwater prawn farming is technically and economically viable, these regulations are less restrictive than those, for example, applying to the culture of temperate aquatic species in Europe and the USA; the governments concerned are keen to encourage freshwater prawn farming. You should ask the advice of your local inland fisheries department, whose officers should be helpful and anxious to participate in your project. In some countries there may be NGOs that can provide the assistance that you need. The ease of access to assistance and advice when the farm is in operation is an important factor in site selection. No matter how competent you are, there will come a time when you need help, such as water analysis, disease diagnosis, and technical advice. These types of assistance can be obtained from government, university and private sources. Do not site your farm too far from someone who can heed your cries of "help!". Speedy access to qualified personnel and to well-equipped laboratories is invaluable. You should always keep in touch with local fisheries officers but do not expect them to know all the answers. No one does!



# Broodstock

## 3.1 Obtaining and selecting egg-carrying females

### OBTAINING BERRIED FEMALES

When freshwater prawn farms are in tropical areas where adult prawns are available year-round, the word broodstock usually refers only to the females that are kept in hatcheries until their eggs hatch, after which they are discarded or sold. The individual value of egg-carrying females is low, especially because they are usually sent to the market after the eggs have hatched, so there is no need to economize in the number used. An indication of the number of berried females required is given in Box 4.

Different considerations apply when freshwater prawns are being grown in temperate regions, as discussed later in this section. Some hatcheries also hold a supply of adult males. Few tropical farms maintain freshwater prawn broodstock in dedicated ponds (a practice which is commonplace in many fish farms), despite the potential advantages (e.g. the ability for selection).

Freshwater prawn eggs are carried under the tail of the adult female prawn (known as 'berried' or ovigerous females) and are easily visible (Figure 4). In the tropics, berried females can be obtained year round from farm ponds containing adult animals but the quantity of berried females available may vary according to the time of year. They can be obtained by cast netting but are frequently selected at times of partial or total harvest. Berried females can also be obtained from rivers, canals and lakes in areas where they are indigenous (native). Some hatcheries prefer to use berried females from natural waters based on the belief that wild females produce better quality larvae than pond-reared ones. However, collecting ovigerous females from the wild often results in considerable egg loss during transport, so many hatcheries prefer to use adjacent rearing ponds for their supplies. The dangers of doing this are discussed later in this section of the manual.

In the wild, berried females are most abundant around the beginning of the rainy season. When *M. rosenbergii* is reared in areas where the climate is sub-tropical or tem-

perate (usually originating from stock introduced from another area), broodstock are typically obtained from ponds during the harvest at the end of the growing season and maintained indoors in environmentally-controlled conditions during winter. When freshwater prawns are introduced into an area where they are not found in the wild, great care must be taken to follow national and international guidelines for introductions, including quarantine. A basic code of practice for introductions is given in Annex 10. The topic of quarantine is fully discussed by Bartley, Subasinghe and Coates (1996). From a hygienic point of view it is better to import PL from sources where no diseases have been reported, rather than berried females. The permission and assistance of the local Department of Fisheries should be sought on this topic.

If your hatchery is close to the ponds containing berried females, you can transport them in buckets of water. If you need to transport them longer distances they can be held in tanks or double plastic bags, using techniques similar to those for moving PL, as

described later in this manual, except that the rostrum of each animal should be blunted with scissors or inserted into a plastic tube to prevent the bags being punctured. In addition, it is recommended that you shade the animals from light during transport; UV light may harm the eggs. Tying the chelipeds with rubber bands or covering them with plastic tubing also reduces the danger of the plastic bags being punctured. Some people wrap the animals in cloth or plastic or nylon screens or enclose them inside perforated PVC pipes, which are then placed into double polyethylene bags. This is not recommended, because immobilisation results in increased mortality rates during transport. The use of small bags containing only one animal and transported in darkness reduces egg losses. You need to take great care in catching, handling and transporting berried females to minimize egg loss and damage.

BOX 4

## Numbers of berried females required

**IN TROPICAL** conditions, assuming that each berried female available is capable of producing enough eggs to provide 20 000 viable stage I larvae, you would need about 50 berried females for each larval cycle of a hatchery using a total larval tank volume of 50 m<sup>3</sup> (e.g. ten 5 m<sup>3</sup> tanks) producing a total of 500 000 PL per cycle (this also assumes a larval survival rate of 50% to metamorphosis).

Berried females should be carefully selected. Choose animals that are obviously healthy and active, well pigmented, with no missing appendages or other damage, and carrying large egg masses. The ripeness of the eggs is also important. As the eggs ripen, their colour changes from bright orange to brown and finally to greyish-brown a few days before hatching (Figure 11). Those carrying brown to grey eggs are the best ones to bring into the hatchery, as their eggs will hatch within 2 or 3 days. It is best to ensure that you do this so that the whole larval batch is of a similar age. This will increase the efficiency of your feeding operations and reduce cannibalism. The number of females required depends on the volume of the hatchery tank(s) to be stocked with larvae, and on the number of eggs carried by each female.

## GENETIC IMPROVEMENT

The topic of broodstock selection and the advantages of maintaining specific broodstock facilities have been discussed by Daniels, Cavalli and Smullen (2000). Genetic selection has been reviewed in Karplus, Malecha and Sagi (2000). Until recently, very little progress had been made in the genetic improvement of *Macrobrachium* although this topic has long been recognized as an area of research that could be expected to yield significant improvements.

**Figure 11**  
The eggs of *Macrobrachium rosenbergii* are carried by the ('berried') females until they are ready to hatch; as they ripen, they change from orange to grey/black (Hawaii)



**SOURCE:** TAKUJI FUJIMURA, REPRODUCED FROM NEW AND VALENTI (2000), WITH PERMISSION FROM BLACKWELL SCIENCE

Freshwater prawns that originate from eggs that hatch early appear to have an advantage in grow-out because they are the first ones to establish themselves as dominant blue claw males (BC). However, there is no evidence that these 'early hatchers' have any genetic advantage over the 'late hatchers'. Therefore it would be pointless to select larvae from only one part of the spawning period to stock larval tanks. Moreover, selecting eggs from only one part of the spawning period could lead to a reduction in genetic variation and an increase in inbreeding. Proper genetic resource management combines selection and conservation of genetic diversity (Tave 1996, 1999).

Most farmers select larger females, which usually carry more eggs, but this may not be good practice. Selecting fast-growing, berried females from ponds three months after they were stocked, rather than choosing large females six months after stocking, has a positive genetic effect on weight at harvest. Collecting the faster growing females and rearing them in dedicated broodstock ponds would enable you to use selection to improve grow-out performance and also give you the ability to hold the animals until their clutch size becomes larger (after later mating moults).

Experiments have shown that cutting off one of the eyestalks (ablation) of female broodstock increases the number of mature females in a captive broodstock and diminishes the time between each spawn. Young females (about 4 months old after stocking at PL size) spawn about 20 days after eyestalk ablation and spawn again after about 30 days.

There is tendency for the performance (growth rate, survival, FCR) of farmed *Macrobrachium rosenbergii* during grow-out to decline after several production cycles where the berried females used in the hatcheries have been drawn from grow-out ponds. This phenomenon, caused by inbreeding and sometimes known as genetic degradation, has been noticed in a number of countries including Martinique, Taiwan Province of China, and Thailand. In countries where *M. rosenbergii* is indigenous the problem has occurred because of the 'recycling' of animals (broodstock for hatcheries being obtained from grow-out ponds and the process being repeated for many generations). In countries where this species is not indigenous the problem may be worse because the farmed stock has normally originated from a very small number of females (or PL), which were introduced to the country many years ago. When the problem of declining yields (and therefore incomes) occurs, it naturally results in the initial enthusiasm of farmers fading. The solution to the problem must be two-fold: using more wild broodstock, and genetic improvement.

Work on genetic improvement began in Thailand in 1998 and one company has recently introduced a new strain of *M. rosenbergii* that it claims has markedly improved performance (Anonymous, 2001b). This manual does not endorse any specific commercial product or source of PL but welcomes this potential solution to the problem of genetic degradation, in principle.

## 3.2 Holding your broodstock in temperate zones

---

In the tropics, where berried females are readily available, special broodstock holding facilities within hatcheries are not necessary, although the advantages of maintaining special broodstock ponds have already been mentioned. However, in temperate zones where freshwater prawns are reared in the summer, indoor broodstock facilities are essential.

In temperate zones it is necessary to provide holding facilities for over-wintering. Broodstock need to be maintained for up to six months and the temperature needs to be above 25°C to prevent loss of eggs. To conserve water and maintain good water quality, a recirculation system is suggested, similar to that used in recirculation hatcheries, as described later in this manual. Nylon mesh netting should be hung vertically or horizontally in the water column (buoyed with PVC piping and floats) and placed on the bottom of the tanks. This minimizes the total tank volume needed, reduces cannibalism, and increases fecundity. The use of large mesh sizes reduces the amount of fouling.

The egg-carrying capacity of the females is reduced at higher broodstock densities. A maximum stocking rate of one adult prawn per 40 L of water is recommended. For every twenty females, you should hold one or two BC males and two or three OC males (each >35 g), if eggs are required 3-4 months after the adults are stocked. If newly hatched larvae are not required until six months after the adults are stocked into broodstock facilities, the number of OC males should be adjusted to three or four per 20 females (to allow for male mortalities).

The total quantity of broodstock to be maintained in temperate facilities obviously depends on the final demand for PL. Only about 5% of the females will spawn together and an adult mortality of 50% should be anticipated during the holding period. Assuming an average of 45 000 larvae/45 g female, obtaining a single batch of 100 000 larvae at the end of the holding season would therefore require you to over-winter about 90 females, each about 45 g in weight (plus, using the proportions and timing indicated in the previous paragraph, 5-9 BC males and 9-18 OC males). This would provide a batch of 100 000 larvae at least once a week, thus allowing your hatchery to supply enough PL to stock 1 ha of ponds (assuming a stocking rate of 5 PL/L and a 50% hatchery survival rate to the PL stage) per week. These numbers can be adjusted according to your needs. It would be foolish to base the whole cycle of operations on a single tank, however; many accidents and other unforeseen circumstances can arise. It is therefore suggested that you split whatever broodstock animals you hold into a minimum of three holding systems.

## 3.3 Managing your broodstock

---

Managing broodstock in outdoor facilities in the tropics is similar to managing grow-out facilities. However, in temperate climates where broodstock are over-wintered, special care is necessary to ensure good health and maintain maximum survival. Broodstock should be disinfected upon arrival at the hatchery by placing them into freshwater containing 0.2 to 0.5 ppm of copper sulphate or 15 to 20 ppm of formalin for 30 minutes. However, it should be remembered that the use of these chemicals in aquaculture is prohibited or controlled in some countries. Aeration should be provided during these treatments. Similar precautions should be taken in handling berried females which are brought into tropical zone hatcheries from ponds or the wild. Adult prawns can then be transferred to holding tanks which contain freshwater at an optimum temperature of 27-31°C.

The water quality for indoor broodstock holding facilities should be similar to that

for hatcheries. The selection and sex ratio of males to females has been discussed earlier. A nutritionally complete diet is essential to promote superior egg production and quality. Commercially pelleted grow-out feeds can be used but need supplementation. Broodstock should be fed at a daily rate of 1-3% of total biomass, adjusted to match consumption. Half of the pelleted ration should be substituted with the equivalent amount of pieces of beef liver or squid (or similar fresh feeds, such as mussel flesh), cut to the appropriate size, at least twice per week. 1 kg of a wet feed is roughly equivalent to 200 g of pelleted diet. Thus, (for example) if the normal daily ration you are providing to your broodstock is 30 g of the pelleted diet, on two days per week you would need to replace half of it with 75 g of the fresh feed. The daily food ration should be given in two equal portions, normally in the early morning and late afternoon. Two broodstock diets designed for *Macrobrachium rosenbergii* are described in Annex 3.

Specific separate facilities for hatching freshwater prawn eggs are rarely used in commercial hatcheries. The most common system for hatching utilized in tropical hatcheries is described in the hatchery management section of this manual. However, especially in temperate hatchery facilities, a separate hatching facility is easier to control. In this system, berried females can be collected from the holding system and placed into a tank where the eggs are allowed to hatch, and stage I larvae are obtained either with a collecting device, as mentioned below, or simply netted from the system. Figure 12 shows a hatch-

**FIGURE 12**  
This hatching system consists of a 300 litre rectangular hatching tank and two 120 litre circular tanks, one for collecting larvae and one to house a biofilter

NOTE: LARVAE CAN PASS THROUGH THE MESH; ADULT FEMALES CANNOT

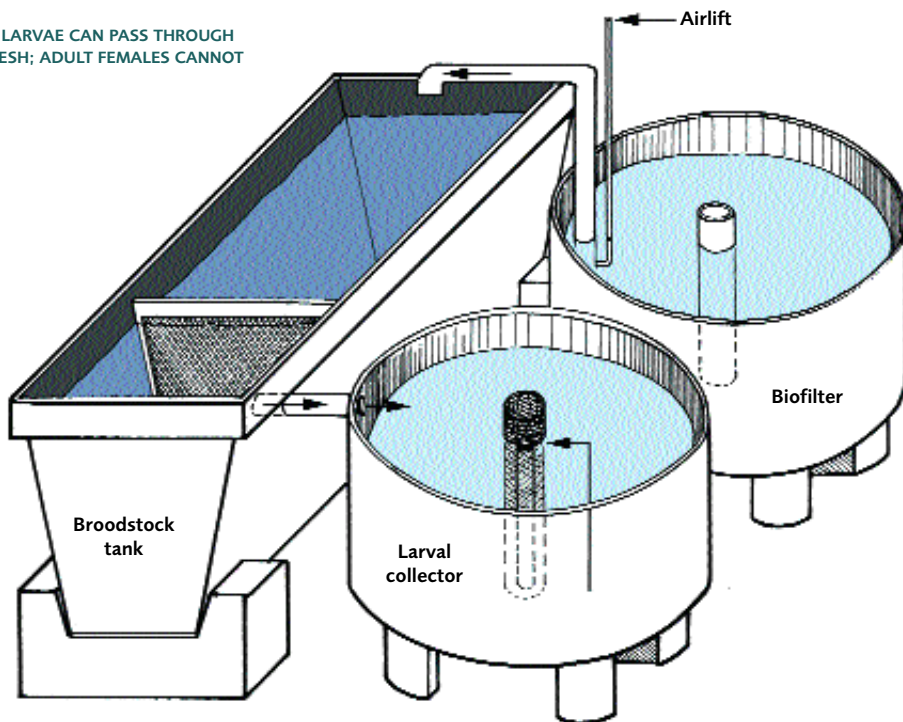

SOURCE: EMANUELA D'ANTONI, DERIVED FROM DANIELS, CAVALLI AND SMULLEN (2000)

ing system that consists of a 300 L rectangular hatching tank and two 120 L circular tanks, one for collecting larvae and one to house a biofilter. Up to sixty females with brown to grey eggs can be placed into the hatching tank, which contains adequate habitat structures (e.g. a piece of pipe for each individual). The hatching tanks need to be covered to exclude light and the interior should be painted with black epoxy-resin paint, except around the area where the overflow pipe is located, which should be painted with a lighter colour, such as beige (or, if the tank is translucent, left unpainted). Black painted grating (e.g. egg crating or louvre material) is used to divide the tank into two chambers.

The largest chamber, occupying about 80% of the total tank volume, is used to hold the females and to keep them separate from the larvae as they hatch. Water overflows into

## FIGURE 13a

### Airlift pumps can be constructed in many different ways

NOTE: THE ONE ILLUSTRATED ON THE LEFT IS MORE EFFICIENT THAN THE NORMAL METHOD OF INSERTING THE AIR PIPE THROUGH THE TOP OF THE ELBOW OF THE WATER PIPE (FOR AN EXAMPLE, SEE FIGURE 13B). THE ONE ON THE RIGHT OF THIS DRAWING IS EVEN MORE EFFICIENT; IN THIS CASE THE AIR GOES FIRST INTO A HOLLOW SEALED COLLAR AND THEN PASSES INTO THE WATER PIPE

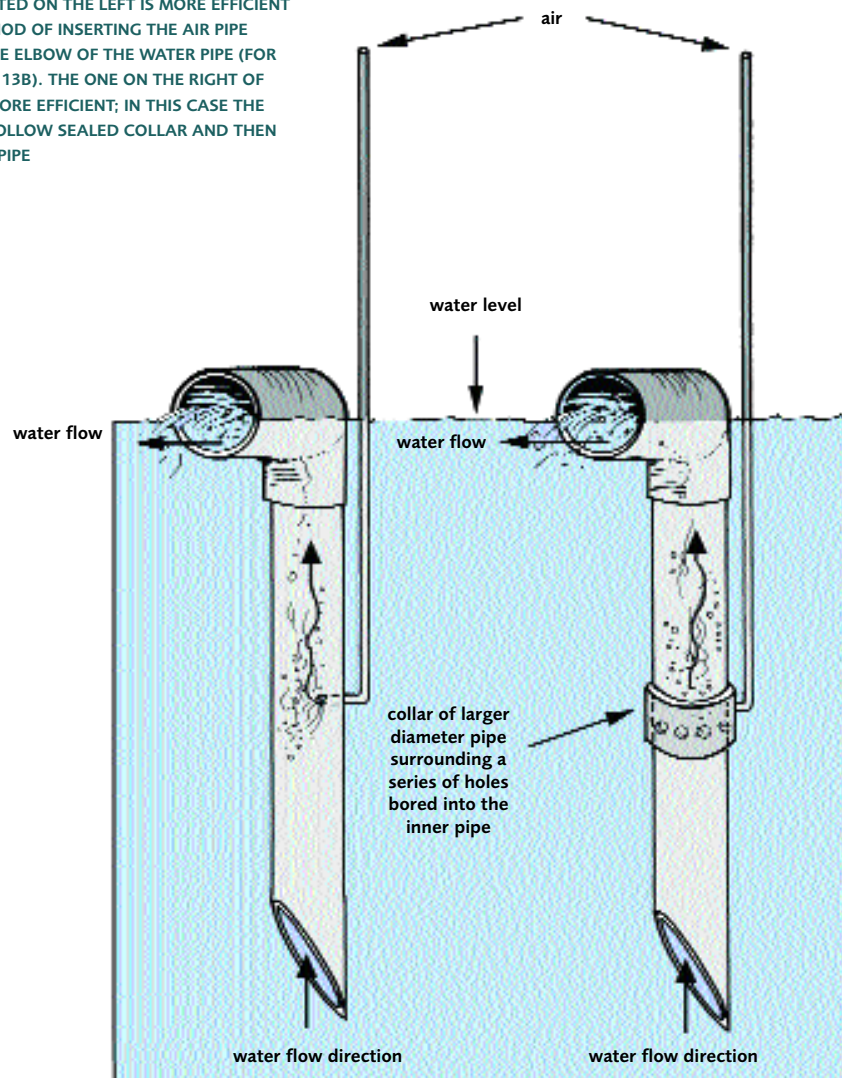

SOURCE: EMANUELA D'ANTONI, WITH ACKNOWLEDGEMENTS TO AREA, HOMESTEAD, FLORIDA, USA

**Figure 13b**  
Airlift pumps  
keep the water moving  
and oxygenated (Peru)

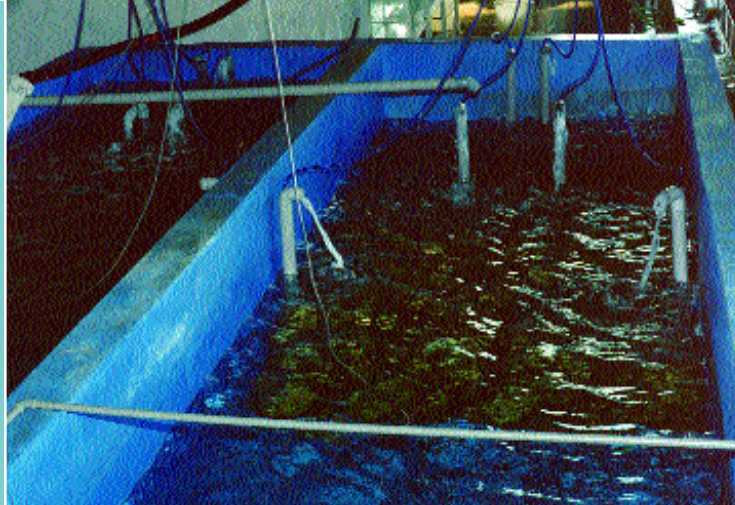

**SOURCE:** OSCAR ORBEGOSO MONTALVA

the collection tank and then passes through a 180  $\mu\text{m}$  mesh screen, located around a central standpipe, into a biofilter. The larvae will flow with the water leaving the hatching tank because they (being positively attracted to light) move towards the lighter area of its wall, which is illuminated. Water is returned to the hatching tank from the filter tank by airlifts (Figures 13a and 13b). Hatching usually occurs at night but as the hatching tanks are covered, larvae can be collected during the daytime. The water in this system should be preferably maintained around 28°C. If you use slightly saline water (~5 ppt) it will result in greater hatchability. Recently, some evidence has been published (Law, Wong and Abol-Munafi, 2001) indicating that the hatching process is extremely pH sensitive. If this is corroborated, the pH may need to be adjusted to 7.0-7.2 for hatching. pH outside this range appears to result in substantially reduced hatching rates. The light regime for the broodstock is not important but direct sunlight should be avoided. To enhance water quality for the hatching larvae, it is recommended that berried females should not be fed at all during the 2-3 day period prior to egg hatching. Larvae are then removed from the collection tank and transferred to the hatchery phase. Further details of this and alternative hatching systems are provided in Daniels, Cavalli and Smullen (2000).





# Hatchery phase

**ALL FRESHWATER PRAWN HATCHERIES** are unique. No precise prototype hatchery would suit every local situation. This manual therefore does not attempt to provide a complete design but it does describe the various features and techniques used in them. This section of the manual is derived not only from the original manual but also draws heavily on recent reviews (Correia, Suwannatous and New 2000; Valenti and Daniels 2000). Two basic types of hatchery are described.

The first type is known as the flow-through system, which is effectively used in many parts of the world and evolved from the original facilities developed by Takuji Fujimura and his team at the Anuenue Fisheries Research Centre in Hawaii in the 1960s and 1970s. The variants of the flow-through system that exist (e.g. high-density culture, 'greenwater' versus 'clearwater' management, coastal versus inland hatcheries) are discussed later in this section.

Recirculation systems involving the use of biological filtration have been developed to conserve water and energy usage, reduce the demand for seawater or brine, and facilitate the establishment of inland hatcheries. They range from simple systems utilizable by small hatcheries to sophisticated systems used for research work and commercial hatcheries. The second type of hatchery described in this section uses a specific form of water recirculation and is known as the dynamic closed system<sup>6</sup>. In the rest of this section of the manual this will be referred to simply as the recirculation system. This is based on continuous circulation of the larval water through physical and biological filters to remove solid and nitrogenous wastes. This system can have individual biofilters for each larval tank or a common biofilter serving several larval tanks. The latter is naturally more risky because a failure in the system may affect a large number of larvae. However, the risk has to be balanced against the capital and maintenance costs of multiple filtration systems.

<sup>6</sup> The alternative recirculation design is known as the static-closed system and is basically similar to the flow-through system except that the water removed from the system during water exchange is transferred to a separate physical and biological filtering unit for treatment, which also involves chlorination and chemical dechlorination, before being returned to the larval rearing tanks. This tends to increase larval stress and mortality and is not recommended in this manual.

**Figure 14a**  
Small hatcheries  
can be very simply  
constructed (Peru)



**SOURCE:** OSCAR ORBEGOSO MONTALVA

**Figure 14b**  
Interior of a  
simply-constructed  
inland hatchery  
for freshwater  
prawns (Thailand)



**SOURCE:** HASSANAI KONGKEO

The general details (facilities and management) for flow-through and recirculation systems are similar. Where there are special requirements for recirculation systems, these are described under each sub-heading of the section.

## 4.1 Buildings and equipment facilities

In tropical freshwater prawn hatcheries, special facilities for holding broodstock do not normally exist. However, they are necessary in areas of seasonal grow-out, where over-wintering of broodstock is essential. This is because you need to start the larval rearing cycle early, so that grow-out facilities can be stocked as soon as the climatic conditions are favourable. Broodstock facilities and management have already been discussed. The size of specific items of equipment depends on the number of postlarvae (PL) to be produced by each hatchery.

### BASIC SITE AND BUILDING REQUIREMENTS

Hatcheries need a reliable power supply, because continuous operation of the aeration system is essential. Even where public power supplies are reliable, you need a back-up generator. You may wish to generate all your own power but a back-up facility is still essential. Power failure can quickly result in total stock mortality. You might think that your hatchery needs to be close to the nursery or grow-out pond locations where your product (postlarvae, referred to as PL) will be stocked. This is preferable but it is technically possible to transport PL for long distances, so it is not essential for technical reasons. Your water supplies - freshwater, seawater, brine, or made from artificial sea-salts - must have excellent quality, as described earlier in this manual. Site location for hatcheries operating recirculation systems is less dependent on the proximity of supplies of seawater or brine, because they minimize the quantities required. When artificial sea salts are used, only freshwater is needed on the site.

In tropical areas tanks in flow-through hatcheries can be situated in the open but you should provide, at the minimum, simple shading (palm fronds or a bamboo framework, for example) where there is a possibility of the water temperature rising too high. Water temperatures may also drop too low in tanks in the open air at certain times of the year for continuous operation. It is therefore better for you to house your tanks in a building, to make it easier for you to control temperature and light and to minimize the entry of insects



**Figure 14c**  
Buildings are often rebuilt as the hatchery prospers but the structure remains simple (Thailand)

and dust. The roof and walls do not need to be permanent. Locally available materials are the best to use. Successful hatchery buildings in tropical areas are often very simple structures, which are easy to extend or re-locate (Figures 14a and 14b). If the hatchery is successful and business is good you can think of extending it and building something more permanent later (Figure 14c).

SOURCE: HASSANAI KONGKEO

If you are building your

hatchery in a temperate zone, a proper building becomes essential for temperature control and efficiency. No exact hatchery design is provided here, for the reasons explained earlier, but a general view of the interior of a flow-through hatchery is illustrated in Figure 15 and a simplified layout for this type of hatchery is shown in Figure 16. A diagram of a single-tank recirculation system is shown in Figure 17.

## EQUIPMENT AND THE DISTRIBUTION OF WATER AND AIR

### Tanks

The focus of every hatchery is the larval rearing tank. Many different types of containers can be used to grow freshwater prawn larvae, including circular flat-bottomed tanks (made from plastic or converted from large-bore drain pipes), circular conical-bottomed (sometimes called cylindrico-conical) plastic tanks, plastic-lined wooden tanks, rectangular concrete tanks, concrete-faced brick or block tanks and earthenware water jars (known in Thailand as 'klong pots' – see Annex 4, Figure 4). There are some advantages in having rectangular tanks. Circular tanks are acceptable, but once you increase the capacity of the hatchery you would need a lot of small tanks or a few very large ones. Large circular tanks are rather cumbersome to use. If you use a lot of small circular tanks you will waste a lot of space between them and you would need a lot of unnecessary pipe fittings, etc. The main advantage of rectangular tanks is that you can build them so that the width

stays the same, whatever the volume, while the length increases as they get bigger. A 10 m<sup>3</sup> rectangular tank is just as accessible for feeding, cleaning and larval inspection as a 1 m<sup>3</sup> rectangular tank.

Suitable materials for tank construction vary

**Figure 15**  
Partially covered larval tanks, made from concrete blocks (Thailand)



SOURCE: HASSANAI KONGKEO

Hatchery layout is site specific; this is one example

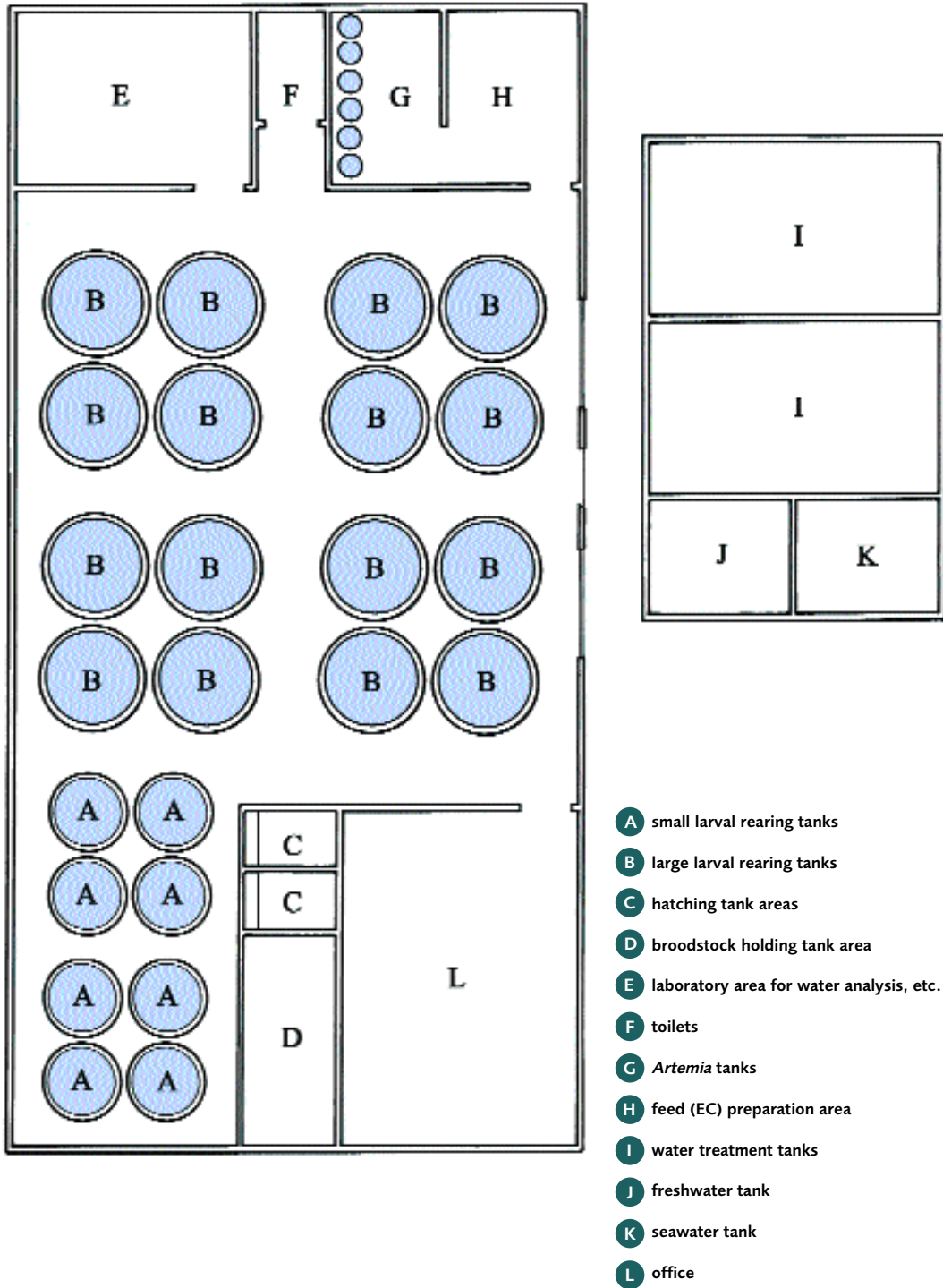

SOURCE: EMANUELA D'ANTONI

This shows the water flow through a freshwater prawn hatchery recirculation system

NOTE: AN OPTIONAL UV UNIT IS INCLUDED IN THIS DIAGRAM

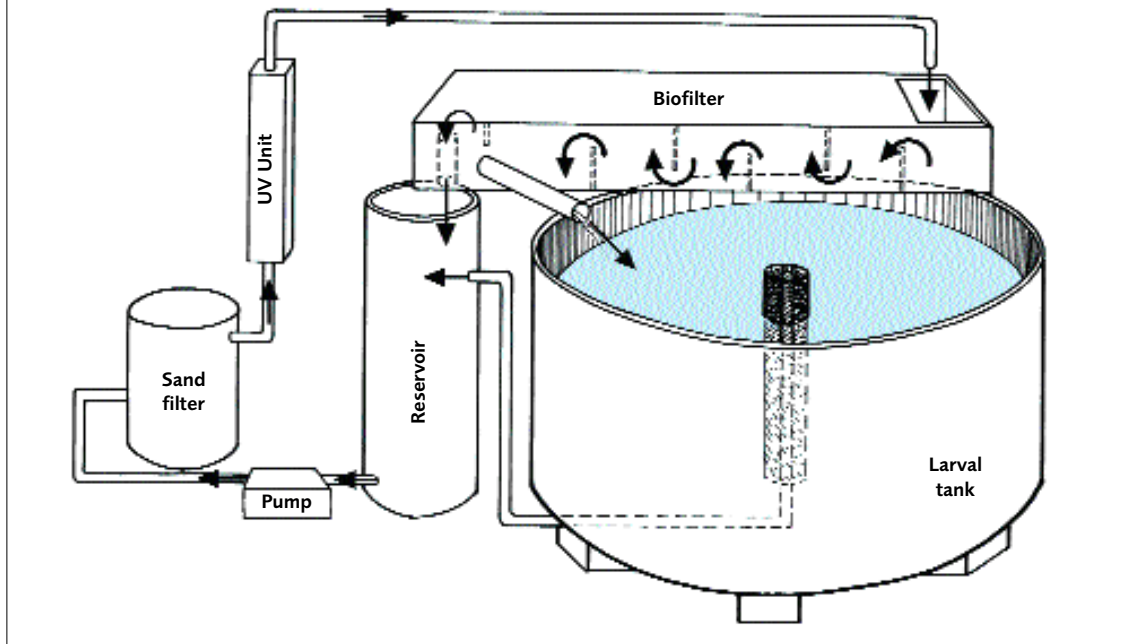

SOURCE: EMANUELA D'ANTONI, DERIVED FROM VALENTI AND DANIELS (2000)

from site to site. Copper and zinc (and their alloys), galvanized steel, bare concrete, and oil are toxic to larval freshwater prawns. These materials must be avoided when tanks are constructed and equipment, such as pipes, water and air pumps, etc. are bought. Rigid plastic, fibreglass or plastic-lined wooden tanks are ideal. The original 'Hawaiian' freshwater prawn tanks were based on a fibreglass interior, with a reinforced layer of concrete 'shot-creted' onto the outside for strength. Tanks can be made from good quality concrete or concrete-faced hollow-blocks which should be reinforced with vertical iron rods. Tanks based on concrete blocks, lined with a smooth concrete surface and coated with several layers of pure epoxy-resin to prevent harmful chemicals leaching out of the concrete, are very successful (Figure 18).

Some people report that concrete structures often crack and need to be re-coated with epoxy-resin (which is expensive) but this may be because of poor construction when they were first built. These tanks must be carefully constructed so that

Figure 18

There can be a lot of wasted space around circular tanks but none is wasted between these rectangular larval tanks (Thailand)



SOURCE: HASSANAI KONGKEO

they do not leak. They must have a firm, well-compacted foundation (a 5 m<sup>3</sup> tank, for example, supports 5 mt of water, plus its own weight). Concrete pouring or facing work must be continuous so that the concrete does not dry out by sections. Failure to do this will later result in cracks and leaks at the joints. Place your larval tanks high enough so that you can drain them by gravity when the turn-down drain is operated. Construct tile, faced block or concrete drainage canals to carry the drained larval rearing water away without undermining the foundations of the tanks. Another argument against concrete tanks is that they are 'permanent' immovable structures. Plastic or fibreglass tanks can be purchased 'off-the-shelf' and can be rearranged if you want to revise the layout of your hatchery. However, buying plastic tanks can be very expensive and many commercial freshwater prawn hatcheries stick to concrete-lined or concrete tanks.

Whatever type of tanks you choose, you must ensure that they have a smooth surface and that all right-angled parts (where the side walls join and the bottom meets them) are 'rounded off' (see Figure 18). This is essential to make efficient tank cleaning easier and to reduce the surface area available for the growth of algae, bacteria and protozoa. Smooth surfaces also decrease the tendency of larvae to concentrate in the corners of the tank. Circular tanks avoid this problem but some hatchery operators find that food distribution and tank cleaning operations are more difficult in circular than in rectangular tanks, because of the difficulty of moving between them in a limited space. Some hatchery operators prefer cylindrico-conical tanks because they find them easier to clean. Figure 19 shows an interior view of this type of tank. The difficulties which hatchery operators have in working around a lot of circular tanks can be reduced by building them in groups, as illustrated in Figure 20. There are obviously many possible alternative choices of tank construction and layout. You must make your own choices; this manual can only point out some of the advantages and disadvantages of each type. Whatever type of tanks you choose, it is essential that you 'age' them when they are new by soaking them in several changes of brackishwater for several weeks. This allows soluble toxic materials to leach out.

Many hatchery managers believe that tanks with coloured (green, blue, black) interiors seem to give better results and there is some research evidence for this. You will note that the tanks shown in Figures 19 and 20 are painted black. Some speculate that the larvae can see their food more easily and are better distributed throughout each tank. However, not all successful hatchery operators agree. Some claim that larvae find their

**Figure 19**  
Inside of cylindrico-conical larval tank, showing the central stand-pipe used during water exchange (Brazil)

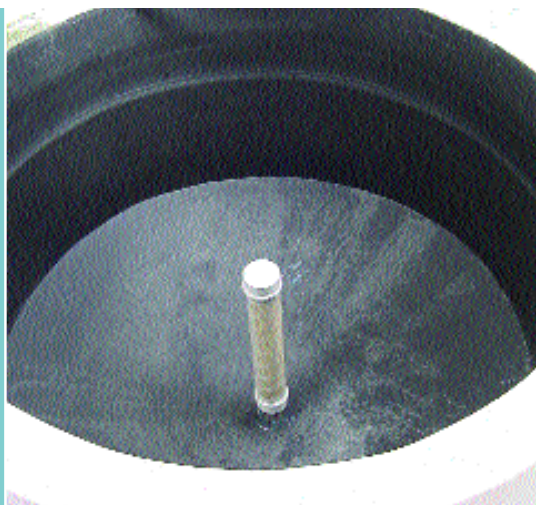

**SOURCE:** EUDES CORREIA

**Figure 20**  
Some space can be saved by grouping tanks together but there is still some 'dead' space between these cylindrico-conical hatchery tanks (Brazil)



**SOURCE:** EUDES CORREIA

food mostly by contact, not sight, and that white tanks make it easier to clean and observe the larvae! The tanks shown in Figure 18 are painted light blue, which seems to be a compromise. Another operator has found that painting the bottom and the lower 30 cm of the tank sides beige and leaving the rest of the tank black provides the best colour contrast to *Artemia* and allows the larvae to feed more efficiently in indirect light. It is therefore not possible to make a firm recommendation on tank colour in this manual (further research may make a clear recommendation feasible in the future). Individual hatchery experience, based on ease of management, observations on the larvae, and (most important of all) success in producing healthy PL in the shortest time and with the best survival rate, is what governs the choice of colour at present.

Individual tank size depends on the number of larvae you want to stock and on whether you find that operating a few larger tanks or a lot of small ones is most convenient. In recirculation systems, individual larval tank size generally varies from 1-8 m<sup>3</sup> and the filters can either be shared (Figure 21) or individual (Figure 22). Tanks of between 2 and 5 m<sup>3</sup> are typical in flow-through systems but some hatchery operators prefer larger tanks (e.g. 10 m<sup>3</sup>). Some hatcheries use a range of tank sizes, so that the larvae can be reared in high densities in small tanks at the beginning (which conserves water and food, and makes management easier) and moved to larger tanks later when they require more space. Other hatchery managers think that the apparent advantages of this style of man-

**Figure 21**  
The water in these larval tanks recirculates through a shared filter (Brazil)



**Figure 22**  
These larval rearing tanks have individual recirculation systems (Brazil)



SOURCE: WAGNER VALENTI

SOURCE: WAGNER VALENTI

agement are outweighed by the larval damage and mortalities caused during tank transfers. For illustrating some management techniques and calculations of water requirements, etc., a standard tank water volume of 5 m<sup>3</sup> has been used in this manual.

Good tank drainage is essential. You have to remove water (during water exchange) and, at harvesting time, PL from your tanks. The interior draining system in a cylindrical-conical tank is clearly shown in Figure 19. If rectangular tanks are used it is essential to slope them slightly toward the drain end. Use a 2 inch (5 cm) turn-down drain for a 5 m<sup>3</sup> tank. Larger tanks will need larger bore drainage pipes (e.g. 4 inch – 10 cm – for a 10 m<sup>3</sup> tank). Smaller tanks can use smaller pipes for drainage but it is important not to make the drainpipes too small or water exchange will take too long. These pipes must be covered with a filter sock inside the tanks made of nylon screen (Figure 23) to prevent the loss of animals during water exchange operations. They can be arranged so that they drain into

# FIGURE 23

Whatever kind of hatchery tank drain you use, it needs to be protected by a filter sock to prevent the loss of larvae during water-changing operations

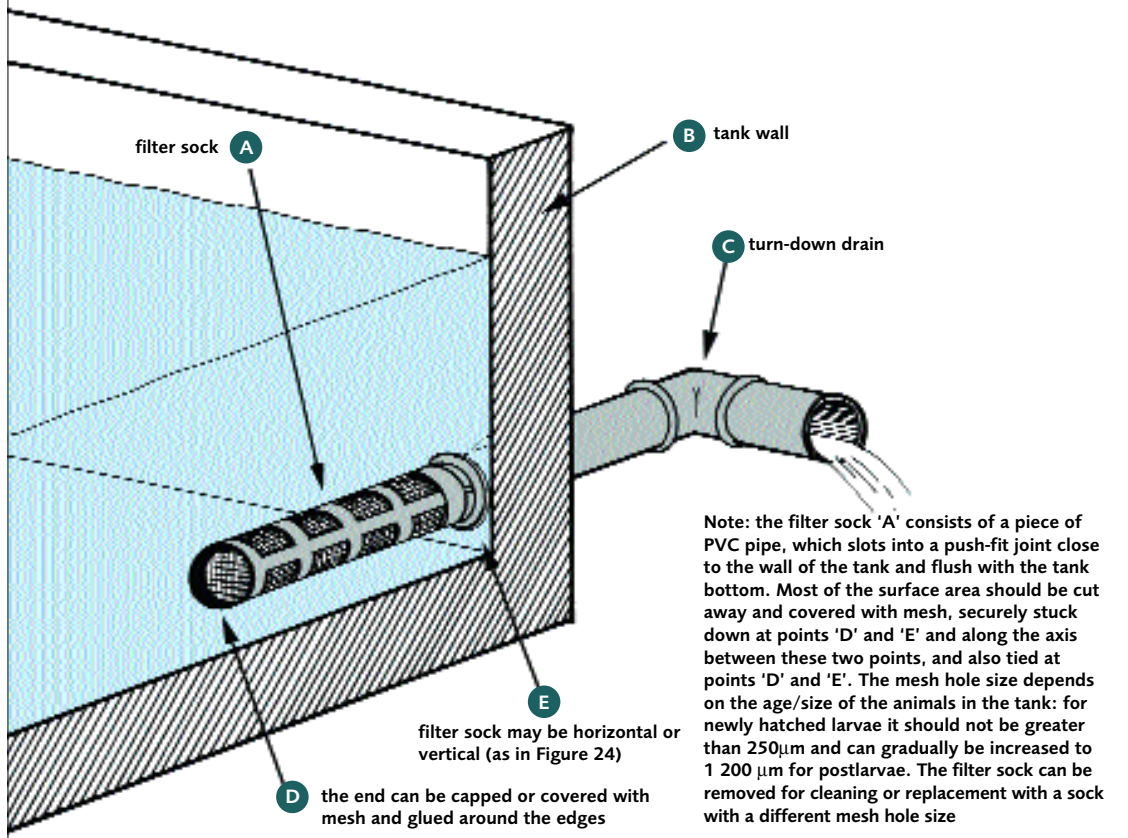

SOURCE: EMANUELA D'ANTONI

a central channel, as shown in Figure 24. You will need to use a mesh size of 150-250  $\mu$ m at first, because the larvae are so small. However, this mesh size drains slowly and you must increase it as the animals grow. By the time you have PL in the tanks you can use a mesh size of 1 000-1 200  $\mu$ m. The filter sock is removed during harvesting operations.

You will also need other types of tanks besides larval tanks. For example, tanks for hatching live feed organisms (e.g. *Artemia*) are required. Mixing tanks are also needed for preparing the brackishwater to be used in the hatchery, as well as storage tanks for seawater or brine and freshwater (Figure 25). Building mixing and storage tanks high enough so that the water for tanks can be distributed by gravity would seem ideal. However, the cost of constructing raised tanks is so high that pumping is normally used for this purpose, as shown in Figure 25. Your hatchery should have a total storage, holding and mixing capacity of at least twice the total volume of its larval rearing tanks (e.g. four 25 m<sup>3</sup> or two 50 m<sup>3</sup> tanks for every ten 5 m<sup>3</sup> larval rearing tanks). This capacity is necessary to allow for adequate water storage, treatment and mixing time for the production of 12 ppt brackishwater. You will also need to provide tanks for holding PL before sale or stocking in nursery or grow-out facilities. The type, size, and shape of materials used in the construction of water storage and supply systems, as well as for postlarval holding tanks, vary according to the site and scale of operations, like the larval tanks. Some tropical hatcheries find that



# FIGURE 24

Turn-down drains are the best way of changing water or harvesting hatchery tanks

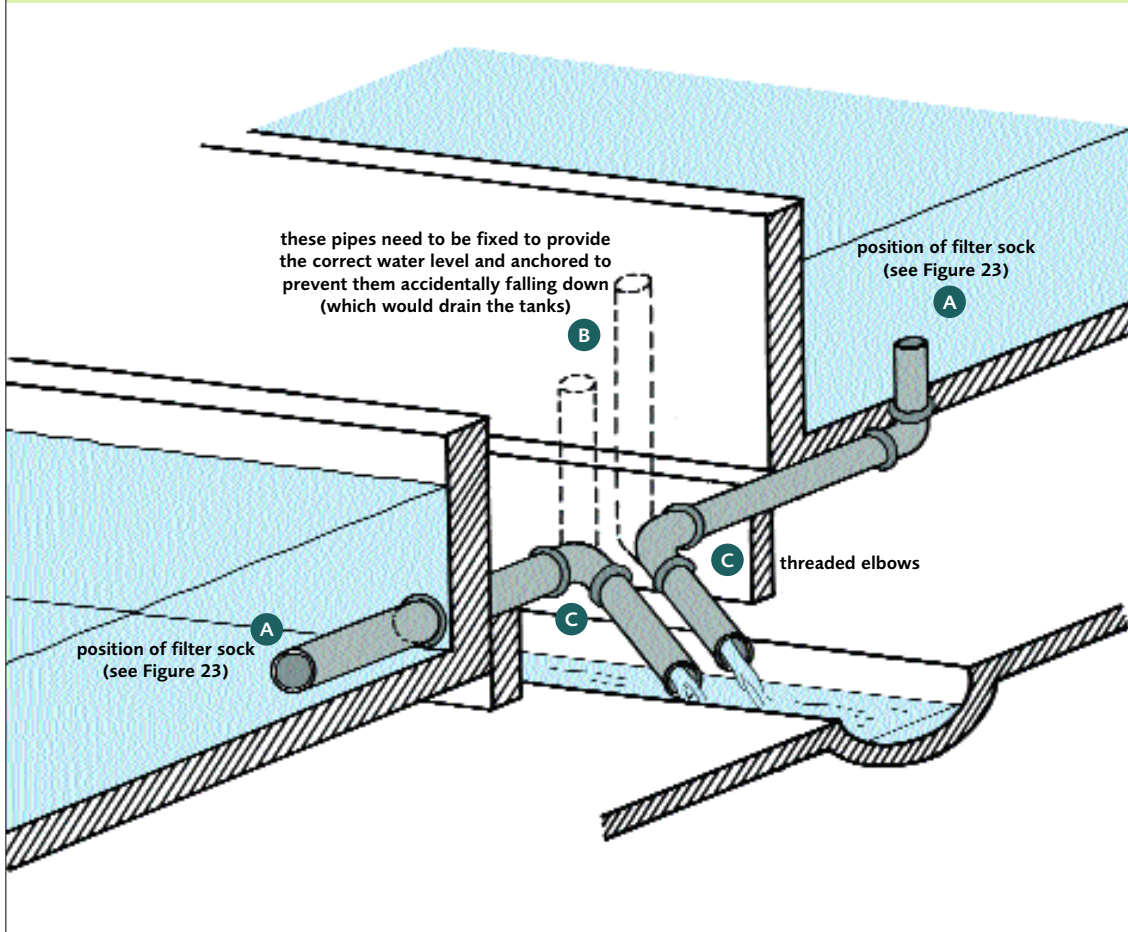

SOURCE: EMANUELA D'ANTONI

**Figure 25**  
Tanks for storing hypersaline water and freshwater, and for mixing purposes at an inland hatchery in Thailand; note the roof and side covers for excluding aerial pollution and controlling temperature



SOURCE: HASSANAI KONGKEO

a convenient size for PL holding tanks is 25 or 50 m<sup>3</sup> but your choice will depend on the number of larval tanks you operate per production cycle.

### Air supply

A vigorous supply of air is essential in all your tanks (larval, *Artemia* rearing, mixing, storage), to keep the dissolved oxygen (DO<sub>2</sub>) levels high (>5 ppm). The relationship between temperature, salinity and dissolved oxygen saturation levels is shown in Table 7. In the larval tanks, aeration also keeps the larvae in close contact with their food. Some hatcheries distribute air through several rigid 0.5-1.0 inch (1.25-2.5 cm) diameter PVC pipes (1.25 cm pipes work best in circular tanks) with holes cut into them at 0.3-0.5 m intervals with a 1/32 inch drill. Others use weighted flexible plastic tubing laid on the bottom of the tank, with holes punctured in them. However, the use of good-quality air stones is preferred.

TABLE 7 | Relationship between temperature, salinity and dissolved oxygen saturation levels (in ppm)

TEMPERATURE (°C)	SALINITY				
	FRESHWATER	7.5 PPT	11.1 PPT	14.7 PPT	36.4 PPT
20	9.1	8.7	8.5	8.3	7.4
22	8.8	8.4	8.2	8.0	7.1
24	8.4	8.1	7.9	7.7	6.9
26	8.1	7.8	7.6	7.5	6.6
27	8.0	7.6	7.5	7.3	6.5
28	7.8	7.5	7.4	7.2	6.4
29	7.7	7.4	7.2	7.1	6.3
30	7.6	7.3	7.1	7.0	6.2

SOURCE: DERIVED FROM SPOTTE (1970) USING KNUDSEN'S FORMULA FOR CONVERTING CHLORINITY TO SALINITY

able because the holes in pipes and flexible tubing easily become blocked. In addition, pipes or tubing on the tank bottom hide detritus, providing conditions favourable for the growth of fungi and protozoa, and making tank cleaning extremely difficult. Airstones are therefore recommended; punctured pipes or plastic piping within the larval tanks are not.

Make sure that the flow of air in one tank is not affected by the number of other tanks in operation or by the operation of valves in an adjacent tank. You can do this by having a large bore 2 or 3 inch (5 cm or 7.5 cm) ring main distribution system (Figure 26) with smaller 0.5 inch (1.25 cm) or 1.0 inch (2.5 cm) pipes supplying each tank, each controlled by an individual valve (Figure 27). The blower should be sized to provide more air than needed (see below) and excess air can be voided through a valve on the ring main, which can be adjusted according to the day-to-day requirements of the hatchery.

The aeration system is a vital part of the hatchery, so it is important that you protect it from damage. The distribution system can be buried for protection against accidental damage by placing it under 4 inches (10 cm) of medium gravel or sand, whether the hatchery is indoors or out-of-doors. Covering any type of hatchery pipe work with concrete is not recommended. An alternative, which is probably preferable, is to suspend the aeration system from the hatchery roof and to drop individual supplies to each tank (see Figure 38). Within larval tanks, air needs to be well distributed, so that it not only keeps the oxy-

# FIGURE 26

Installing a ring main air supply system using larger bore piping than you use to connect the main to each valve helps you to ensure that each tank receives the amount of air you wish it to have

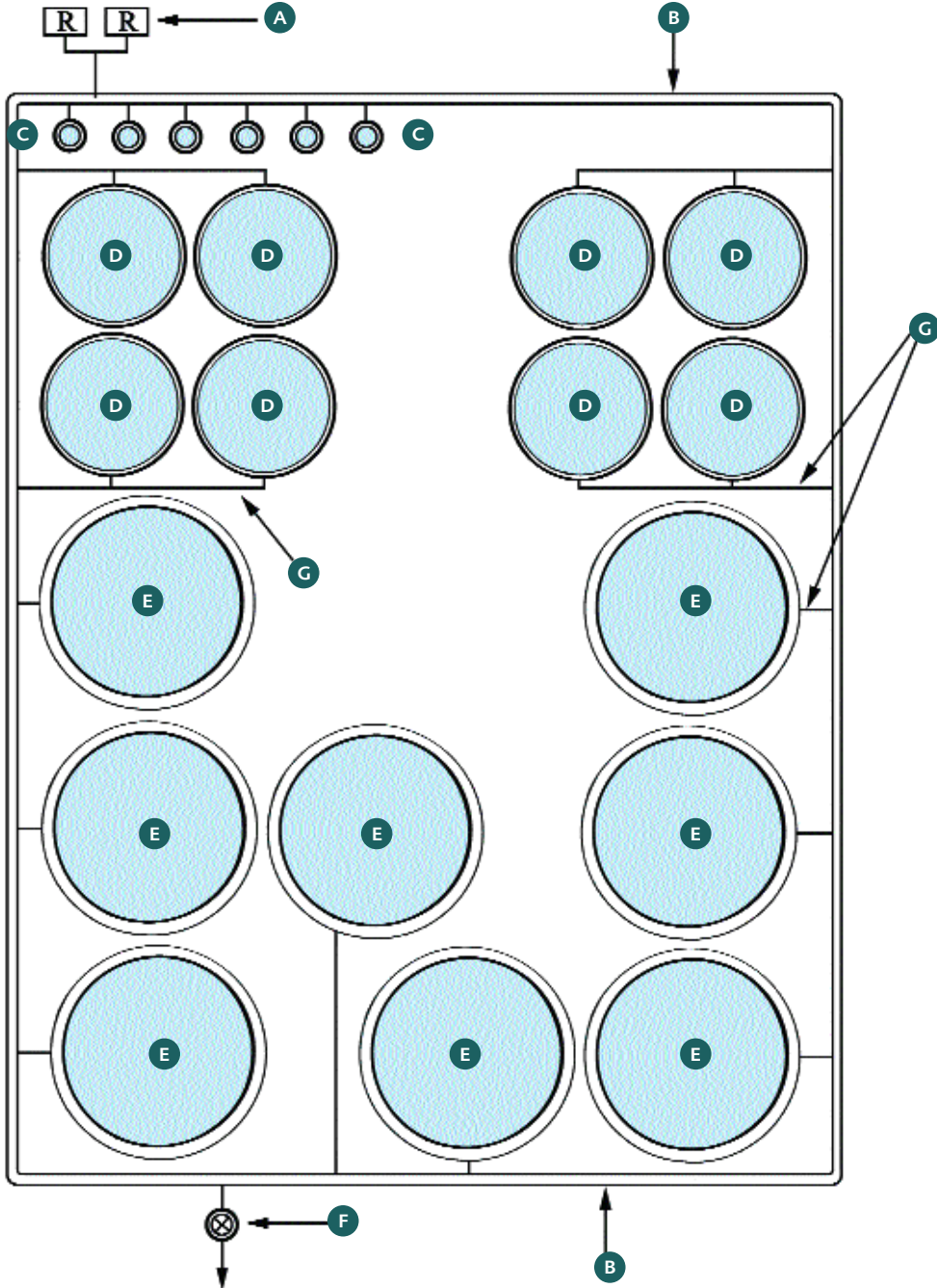

- A** two rotary blowers (one for standby)
- B** 3 inch PVC pipe ring main
- C** *Artemia* tanks
- D** hatchery tanks
- E** water storage and mixing tanks and postlarval holding tanks
- F** bleed valve (can be adjusted, according to demand for air but must never be shut)
- G** 1 inch air supply to individual tanks

SOURCE: EMANUELA D'ANTONI

**Figure 27**  
Close-up of taps for brackishwater, freshwater and air supplies to larval tanks (Brazil)

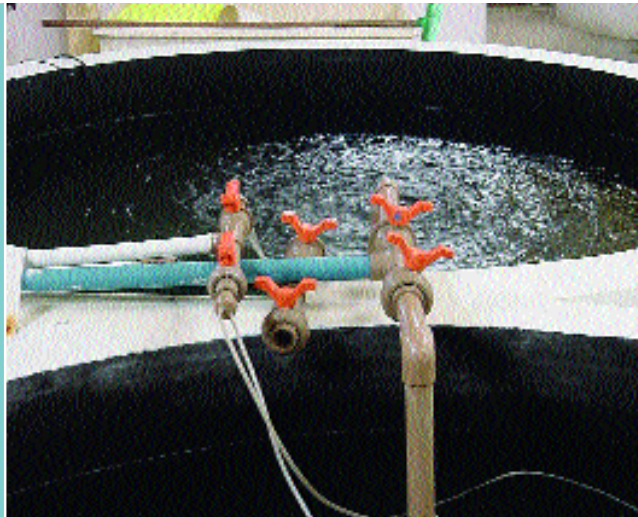

SOURCE: EUDES CORREIA

gen level in the whole tank high but also keeps the larvae close to their food. Distribute the air within your larval tanks by air stones (roughly placed at one per m<sup>2</sup> of tank bottom. Internal aeration in tanks used in recirculation systems, in addition to maintaining dissolved oxygen levels high, must be placed so that it generates water circulation from the centre of the tank to the sides and from the top to the bottom. If this is not done, it will cause 'dead spots' in the tank, where larvae and feed drop out and are trapped near the bottom, and solid wastes will not be removed for treatment in the filters. Failure to tackle this topic will result in an excessive build-up of bacteria, causing water quality and disease problems.

An oil-free blower (Figure 28) is better than an air compressor for hatcheries, because it gives high volume, low pressure, uncontaminated air. The high pressure provided by an air compressor is not normally needed, except for flushing filters in recirculation systems. Approximately 0.3 CFM (0.55m<sup>3</sup>/hr) of air for each cubic metre of water should be available. A 200 CFM (5.66 m<sup>3</sup>/min) Roots-type or similar blower is sufficient to supply air for a hatchery capable of producing 20 million larvae/year. You must keep a spare blower and motor in working order at all times. You should rotate the use of the blowers regularly. Do not always operate one and hope that the other one will work when you need it in an emergency. You should also check that both blowers are in working order once per day. Your spare blower must be permanently plumbed and wired in so that it can be switched into the system immediately if a failure of the other blower should occur. Two forms of back-up (against pump failure and power failure) are illustrated in Figure 28. A pressure drop sensor can be built into the air distribution system, which will switch the emergency blower on automatically if the main one fails but this is uncommon in most freshwater prawn hatcheries, which rely on vigilant workers (during the night as well as the day) and power failure alarm systems for safety.

### Water distribution

Water distribution systems within hatcheries vary widely. Many hatcheries are built with elaborate and permanent distribution systems providing an individual supply of piped seawater, freshwater and brackishwater to every tank, as shown in Figure 27. An example of a water distribution layout for a flow-through hatchery is shown in Figure 29. In some commercial hatcheries these cease to be used after a while; there is a tendency for water quality to deteriorate because it may have lain stagnant in the pipes for some time. Such sophisticated water distribution systems can be replaced by flexible tubing and submersible pumps. Submersible pumps are easy to use if the hatchery is compact, but if you use them without care it may result in contamination between untreated and treated water supplies, and possible disease transfer between one rearing tank and another.

The individual tank water inlets can be arranged so that they can be turned away from the tank and water can be flushed to waste before it is directed into the tank. This prevents water from entering the larval rearing tanks that may be stagnant or very warm because it may have come from pipes exposed to sunlight. Another way of ensuring that this cannot happen is to fix a short length of flexible hose to each water inlet and always allow the water to flush to waste for a minute or two before letting it flow into the tank.

The choice of pump size depends on the scale and design of each specific hatchery. As noted earlier, specific hatchery design is not a part of this manual. In sizing, pumps should be chosen which will fill the appropriate tank at the maximum rate required, not the average rate. There is nothing more annoying than a slow-filling tank due to pump under-sizing. Copper and zinc are toxic to freshwater prawns but there should be no problem in the use of pumps containing alloys of these two metals (which are often chosen, particularly for seawater pumping, because of their corrosion resistance) where the water passes through the pump only once. Pumps which are submerged in water (submersible pumps), or which form part of recirculation systems, must have those parts in contact with water made of an inert material, such as plastic. Air lift pumps (see Figures 13a and 13b) are also extremely useful for recirculating water or for transfer of water from one tank to another. In all cases, pump sizes should be standardized as far as possible to minimize the number of

standby pumps necessary. Make sure that you can replace an out-of-order pump simply and quickly and keep adequate spares in working order on site at all times. Maintaining equipment such as pumps, blowers and generators in good general working condition is critically important. These items should have a weekly functional check.

In recirculation systems, proper water flow rates and good circulation is essential for adequate waste removal. All equipment must be capable of supporting the maximum water flow rate needed during the larval cycle. Ideally, the total water volume in the larval rearing tanks should circulate through the filter an average of at least 10 times per day (1 000%) but pump sizing should be based on the maximum flow demand. When the larval



SOURCE: HASSANAI KONGKEO

**Figure 28**  
Power supplies are not always reliable. Loss of aeration can quickly cause devastation in a hatchery. This hatchery has not only installed two electrically-driven blowers (one as a back-up) but has also provided a petrol engine so that the drive belts can be rapidly changed if the power fails (Thailand)

stocking rate is high, the water may need to be passed through the filter at a turnover rate of 70 to 100% per hour. Thus a 5 m<sup>3</sup> larval culture system would require a system capable of providing a water flow of 5 m<sup>3</sup>/hour. This can best be done through the use of airlift pumps (see Figures 13a and 13b). All pumps, filters and disinfection systems must be sized to provide this maximum flow rate. Useful information on pumps and pumping for aquaculture is given in Wheaton (1977).

# FIGURE 29

The water distribution and treatment system is site specific; this is one example

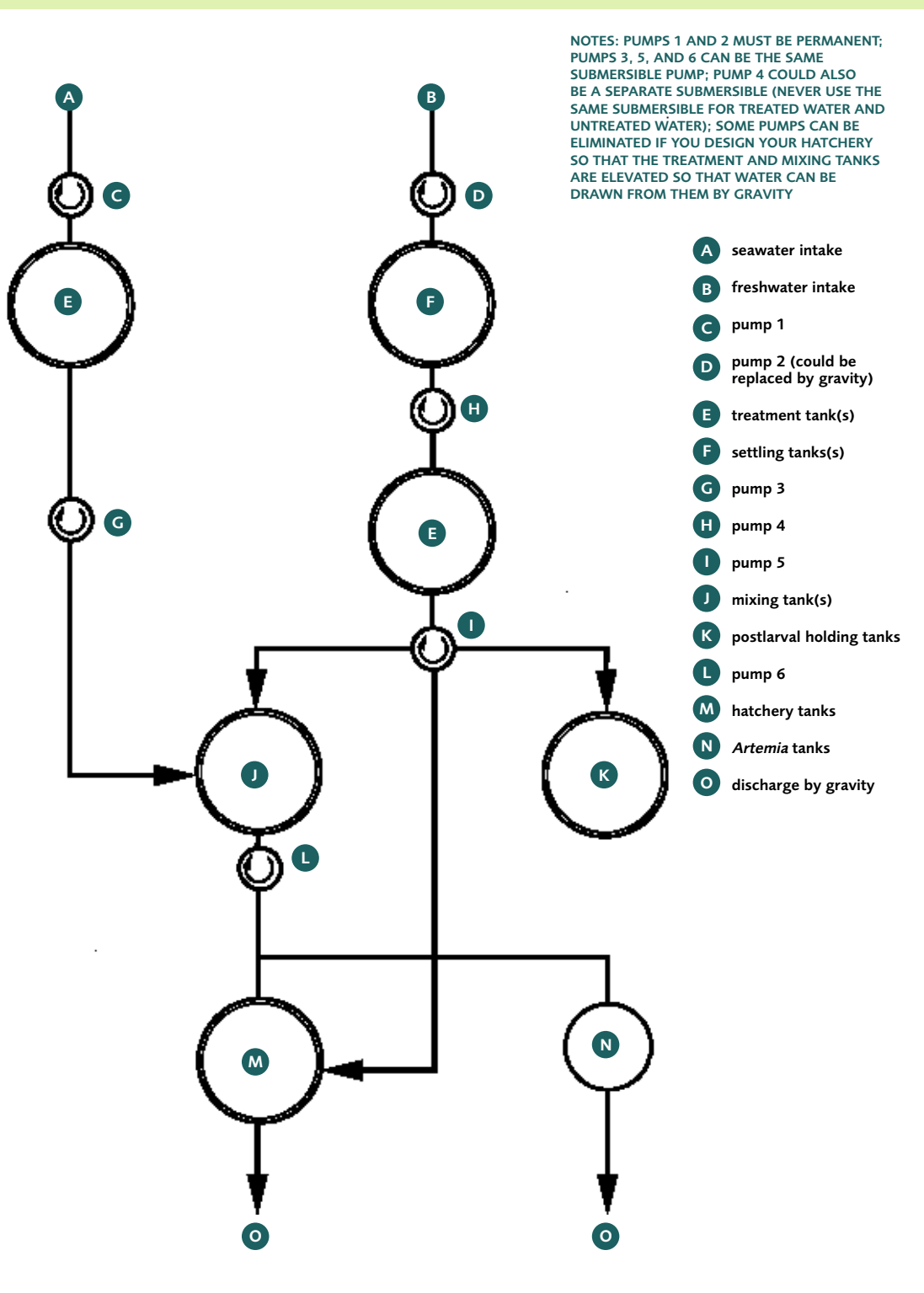

SOURCE: EMANUELA D'ANTONI

## Water discharge

You should take care to see that water discharged from your hatchery does not contaminate the incoming sources of hatchery freshwater and seawater. This is particularly important where surface sources of water are utilized. In a coastal hatchery using surface seawater, tidal and current characteristics should be taken into account in determining the locations of the intake in relation to the farm effluent discharge. Where surface freshwater is taken from a river the farm effluent should be discharged well below the water intake point. Do not discharge water containing chemicals, such as heavy loads of chlorine for equipment disinfection, into open waters.

## Light

The 'greenwater' larval rearing system, which has generally fallen out of favour in commercial hatcheries in the past decade, obviously required light. The phytoplankton bloom in those systems provided shade for the larvae and helped to maintain good water quality. Nowadays, almost all freshwater prawn hatcheries operate a 'clearwater' system. You should not expose larvae to direct sunlight, which appears to be harmful. It is therefore recommended that 90% of the surface of 'clearwater' flow-through tanks kept outdoors should be covered. The material used to cover the tank can be whatever is locally and cheaply available, provided it does not disintegrate when exposed to sunlight, heavy rain or strong winds. This prevents the growth of phytoplankton and reduces the incidence of what Takuji Fujimura referred to as 'skin cancer'.

Some outdoor backyard hatcheries completely cover their hatchery tanks with black tarpaulin to prevent the spray generated by the aeration in neighbouring tanks transferring disease organisms. Most hatchery managers insist that some light, especially natural light, is essential for good larval survival; they therefore provide transparent roofs to their hatcheries but partially cover their tanks with asbestos or plastic sheeting to keep light to a minimum (see Figure 18). Natural light can be replaced by artificial sources (tungsten or special blue-black fluorescent tubes) which contain the near-blue (non-toxic) ultraviolet wavelength. Successful rearing has been reported at light intensities varying between 250 and 6 500 lux. However, a level of 250-800 lux is recommended for commercial hatcheries. Natural light is preferable but you can use artificial light to increase the intensity on cloudy days and to extend the day length. Excessive growth of algae tends to foul the biofilters in recirculation systems and you should shade these filters, while providing indirect light to the culture tanks themselves.

## Filters

Two types of filtration equipment are used in hatcheries, physical and biological. Physical filters remove the solid wastes, mainly faeces, uneaten feed and bacterial debris. Biological filters, sometimes called biofilters, are essential components of recirculation systems for freshwater prawn hatcheries. They remove the ammonia excreted by the larvae and live feeds, as well as that formed by the decomposition of organic matter. In these filters, ammonia is converted first to nitrites and then to nitrates. Some physical filtration occurs within biofilters. Solid wastes are also removed during daily tank siphoning.

Physical filters include sand filters, drum screen filters, and expanded media filters (e.g. bead filters). They can be either up-flowing (Figure 30) or down-flowing but need to be easy to clean and should be designed to minimize water losses in the system. Sand or bead filters may be adequate for freshwater prawn hatcheries. However, drum screen filters do not clog so much and have an automatic backwash. In sand filters a particle size of 850 µm

The water in physical hatchery filters may flow upwards or downwards; this illustrates an upward-flowing filter

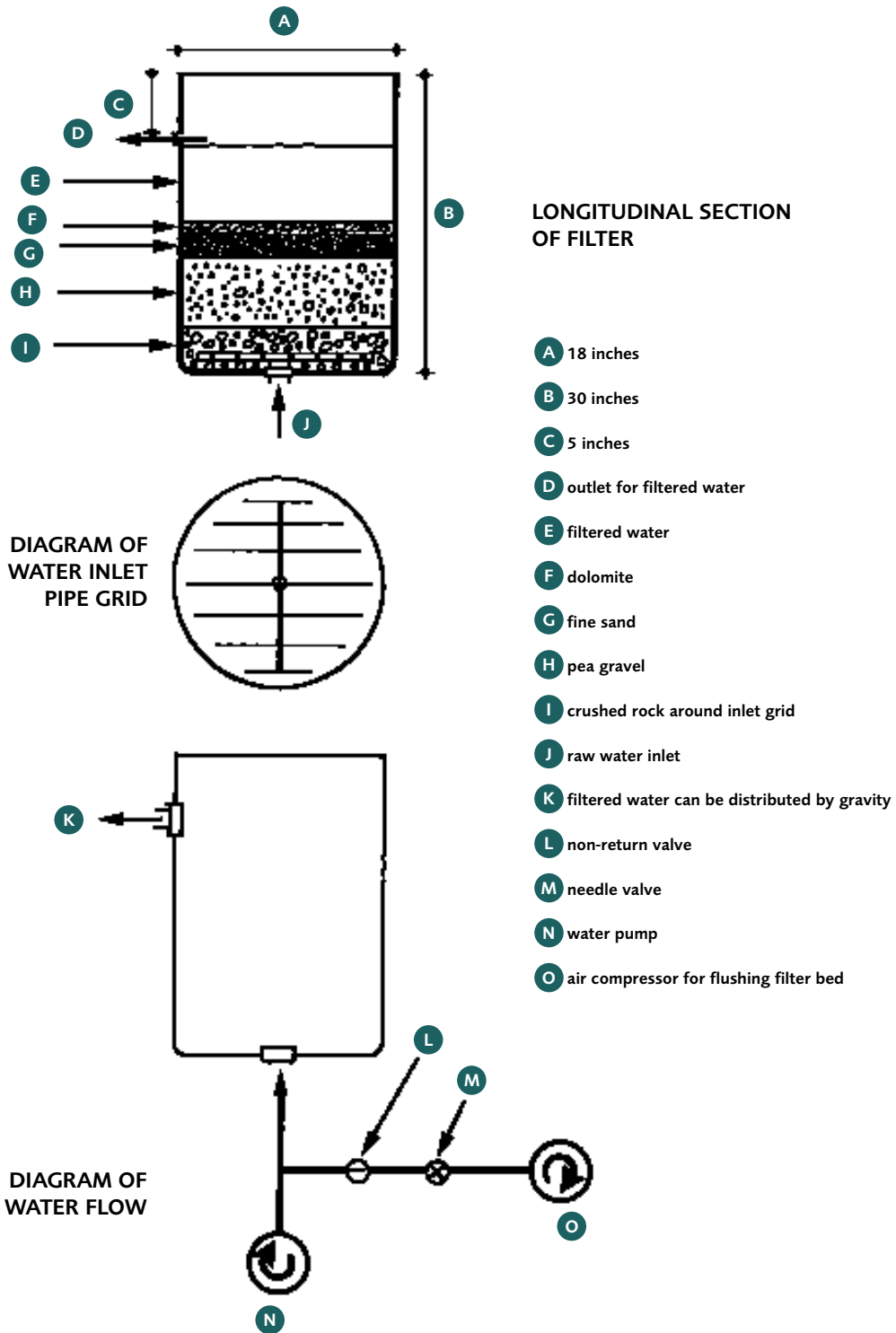

SOURCE: EMANUELA D'ANTONI, AFTER NEW AND SINGHOLKA (1985)



is recommended. The volume of these filters needs to be calculated so that they can cope with the volume and flow rate of the specific recirculation system you propose to run. Physical filters are typically placed in the system before the UV units (if used) and the biofilters, for maximum efficiency. They need to be flushed on a regular basis (at least once a day) to prevent them becoming blocked up with organic material and becoming potential sources of pathogenic bacteria. Sand filters can be backwashed with freshwater and air to save on brackishwater (this is especially important when artificial seawater is used). If water is going to be passed through UV units, substantial particle reduction is required to reduce the amount of suspended matter, thus improving the efficiency of this form of water treatment. UV treatment is uncommon in freshwater prawn hatcheries but future research may demonstrate whether its use would be advantageous.

Biological filters are essential in recirculation systems (Figure 31). There are several types of these filters (Figure 32). Submerged biofilters are efficient, simple, and cheap. The type that is horizontally divided into chambers (as shown in Figure 31) seems to be the most efficient. Biofilters require aeration to maintain enough dissolved oxygen to supply the nitrifying bacteria. It is recommended that the biofilters in a recirculation hatchery for freshwater prawns should have a volume equivalent to about 10% (range 4-20%) of the total tank volume. Crushed oyster shell, dolomite [ $\text{CaMg}(\text{CO}_3)_2$ ], or coral (5 mm particles) is suggested as the filter medium (this provides the surface area where the nitrifying bacteria live). There is a tendency for the water in recirculation systems to become acidic (the pH value falls) but calcareous media contain an inexhaustible source of buffer material (carbonate and bicarbonate ions), which slowly dissolves into the water. However, plastic filter media, which have no buffering capacity, are often used in biological filters. This is because they are easy to handle and are supplied in shapes and particle sizes which maximize the surface area available to the nitrifying bacteria. Recirculation systems using plastic media may eventually need buffering by the addition of sodium bicarbonate ( $\text{NaHCO}_3$ ) or sodium carbonate ( $\text{Na}_2\text{CO}_3$ ) to the water to maintain its pH at 7.0-8.5. Using a calcareous filter media avoids this problem. Placing the filter medium in plastic or nylon bags makes handling easier. It has been estimated that a system rearing 2 million larvae would require about 500 kg of crushed coral within the biofilters once the larvae reach a maximum biomass. This can be modified according to the specific scale of hatchery operations.

Biofilters need to be 'activated' before use. This means an initial bacterial inoculum needs to be added to the larval rearing system to reduce start-up time; the bacteria will

**Figure 31**  
Close-up of a biological filter shared between two larval tanks in Brazil, showing the water entering the mechanical filters (foreground), from where it passes through the biological filter and exits back to the two tanks by means of simple airlift pumps



SOURCE: WAGNER VALENTI

There are many types of biological filters for hatchery recirculation systems; these are the most common types

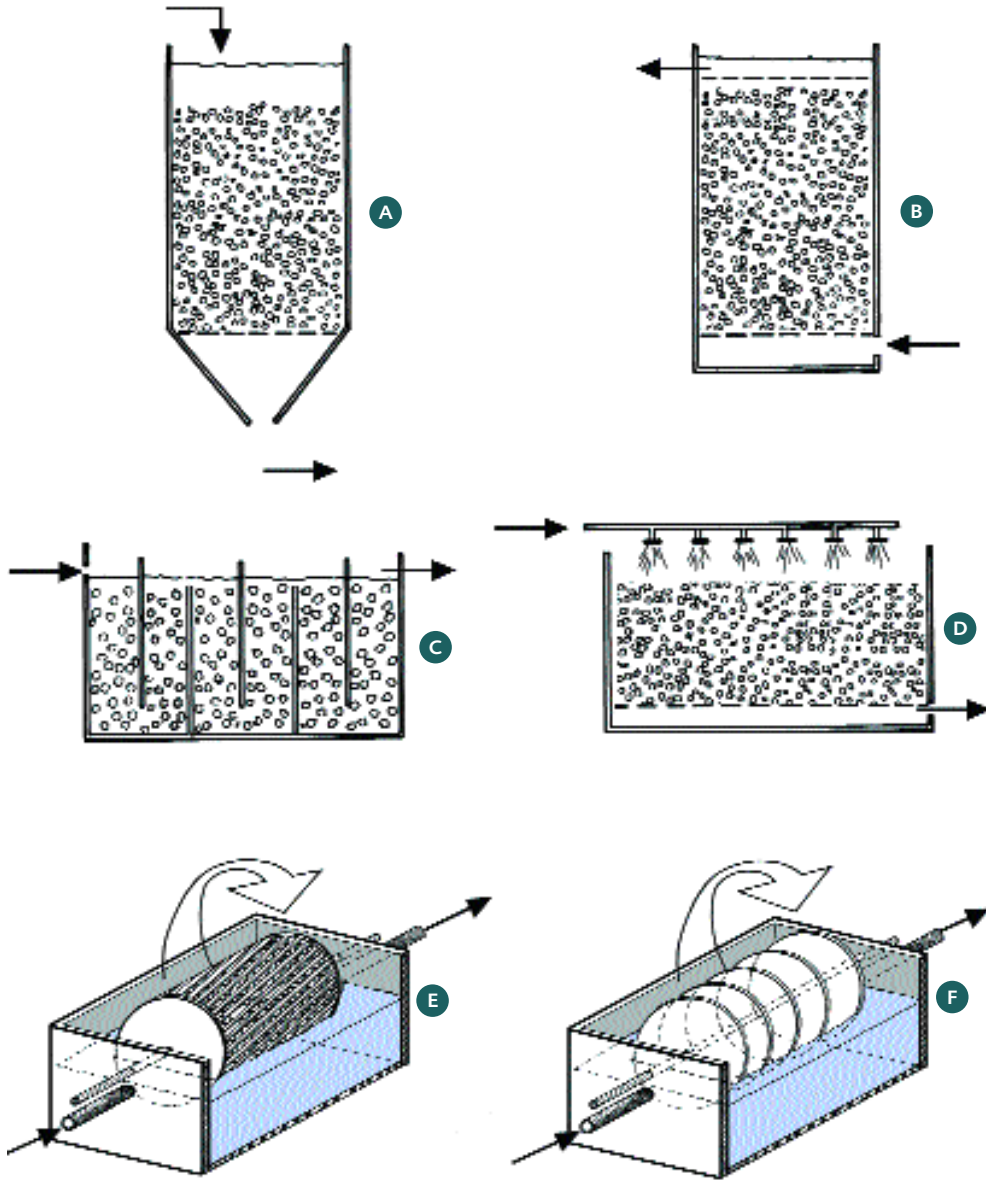

- A** submerged downflow filter
- B** submerged upflow filter
- C** submerged horizontal filter divided into chambers
- D** trickling filter
- E** biodrum (rotating cylinder containing plastic substrate)
- F** rotating discs (in reality, these discs are very close together and form the substrate for the filter bacteria)

SOURCE: EMANUELA D'ANTONI, DERIVED FROM NEW AND VALENTI (2000)

then multiply to cope with the nitrogenous load in the water of the system. The bacterial inoculum can come from another operational filter or from a separate pre-conditioning tank, which is run at the same temperature and salinity as the larval culture tank. Further details on biofilter activation, derived from Valenti and Daniels (2000) are given in Box 5.

The filtration technology used in marine fish and shrimp hatcheries is generally more sophisticated than the methods described above. The application of these techniques to freshwater prawn hatcheries may prove beneficial in future. Detailed information on these systems is available in Van Wyk *et al.* (1999) and Moretti *et al.* (2002).

### Miscellaneous equipment

Many items of small equipment are essential in every hatchery. These include, for example, buckets, epoxy-resin paint, weighing scales, fibreglass repair kits, nets, tools, nylon and cloth mesh, brushes, flexible tubing, postlarval transport equipment (bags, tanks, portable air supply, etc.) spares for electrical equipment, disease prevention drugs and chemicals, spares for PVC pipe work and valves, kitchen equipment for feed preparation, refrigerator, stereoscopic microscope (with a magnification range of 40 times), refractometer (for measuring salinity), pH meter, heaters, beakers, glass jars, various chemicals, etc. All equipment needs to be suitable for use in seawater and free from potential contamination from the leaching of metals such as copper, brass, or zinc.

## Activating biofilters

**A**CTIVATION IS A step-wise procedure that may begin with an inoculation, using water or media from an existing system, or can start from scratch. Initially, add 10% of the total ammonia that you expect to be generated in your larval system to the water containing the substrate material in the form of ammonium chloride ( $\text{NH}_4\text{Cl}$ ) or another inorganic source. When this amount is consumed by the bacteria (as evidenced by the reduction in total ammonia in water samples), add the same amount of ammonia again. Repeat the process until the bacteria are able to convert all the ammonia into nitrate within a 24 hour period. Then

add double the initial amount of ammonia and repeat the process. Keep adding ammonia, monitoring the removal of ammonia and doubling the amount of ammonia added until your biofilter can cope, within a 24 hour period, with the maximum amount of ammonia expected to be generated when there are larvae in the tanks. Once that maximum bacterial load is achieved, the production cycle can begin.

The bacterial population on the media needs to be maintained at the maximum level of ammonia and nitrite consumption. Addition of media to the biofilter should coincide with the increase of  $\text{NH}_3\text{-N}$  produced by an increase in the larval

biomass. Beginning 3 days post-stocking, increasing amounts of 'activated' media must be added daily to the biofilter tank. The bacterial population provided through daily addition of media should always be sufficient to remove all ammonia and nitrite.

When the larval cycle is complete, remove all the biofilter media, thoroughly rinse it, and either store it dry or return it to the pre-conditioning tank to re-establish and maintain the bacterial colony. Alternatively, the substrate can be chlorinated to kill all bacteria, de-chlorinated, and then re-seeded with stock bacteria from another pre-conditioning tank.

## 4.2 Hatchery management

Each cycle of operations in a freshwater prawn hatchery takes up to 40 days, including the time necessary to prepare for the next cycle. Careful attention to all aspects of hatchery management is essential to achieve success (the production of the maximum number of healthy postlarvae at the cheapest cost).

### WATER TREATMENT

Water needs to be treated before it can be used in the hatchery. Usually, it is necessary to pass incoming water through some form of physical (gravel/sand bed) filter (see Figure 30). If the incoming water is not filtered, or is still turbid, it may be necessary to allow the solids to settle in one tank before transferring it to another tank for treatment. Mix the seawater or brine with freshwater to form 12 ppt brackishwater (see Table 4). Then treat the water as in Box 6.

Water drawn from underground sources may not need to be settled. However, the removal of protozoa and bacteria by chlorination, as indicated in Box 6, is still essential. Other forms of water treatment may be helpful. Some hatcheries filter the brackishwater before use through 5 µm filters but most commercial hatcheries omit this step. Some add 10 ppm of the chelating agent EDTA to larval rearing water to improve performance. Others use water which has a potentially unsuitable iron content (see Box 1).

Water quality remains important, not only in the incoming supply but also within the hatchery itself. Monitor the water in your larval tanks frequently to see that its quality

is being maintained (Box 7). Simple field kits can be purchased to check the parameters listed in Box 7 but they are not specified in this manual because they are standard water quality items. For small flow-through hatcheries it is not practical to install facilities for the other types of analytical work, especially where they involve the analysis of seawater or brackishwater. Samples of water for the analysis of other parameters, such as hardness, metals, pesticide residues, etc., should be sent to governments, universities or private laboratories who have the facilities and staff to deal with them. Further reading on water quality and analysis is available in Boyd (1979).

If you are using a recirculation system, adjust the salinity and temperature to 5-7 ppt and 28 to 31°C, allowing the system to stabilize before stocking. This salinity allows larvae to be stocked directly from the hatching tank without acclimation. The salinity in the culture tank should then be increased to 12 ppt. Neither artificial brackishwater nor freshwater should be added through the biofilter tank once the biofilter substrate has been added. Its bacteria are sensitive to sudden changes in tempera-

BOX 6

### Treatment of brackishwater

**A**LLOW IT TO STAND so that any sediments will settle. It is essential to remove as much of the suspended solids as possible, otherwise the chlorination that follows may be partially or totally ineffective

Chlorinate the brackishwater with 5 ppm of active chlorine<sup>7</sup>.

Allow the water to stand for one day.

Remove the residual chlorine by vigorous aeration for 6 hours before use (**note**: sodium thiosulphate can be used to remove the residual chlorine more quickly but its use is **not** recommended because it also may prove toxic to larvae. Vigorous aeration for 6 hours is adequate).

<sup>7</sup> Both dry and liquid sources of chlorine vary considerably in their chlorine content from product to product and from batch to batch. It is best to determine the level of chlorine in each batch before use, to ensure that you are actually using the quantity of chlorine that you think you are adding. The methods for determining the level of chlorine in commercial bleaching powder or liquid bleach are contained in Annex 4, Table 6.

# Regular monitoring of larval water quality

BOX 7

**T**HE FOLLOWING PARAMETERS should be measured in flow-through hatchery tanks:

**TEMPERATURE**  
**pH**  
**SALINITY**  
**DISSOLVED OXYGEN**

**NOTE:** dissolved oxygen meters are very expensive in some countries. Monitoring this parameter is ideal but can be omitted if you are sure that your aeration system is working perfectly

The following additional parameters should be measured in recirculation systems:

**AMMONIA**  
**NITRITE**

ture and salinity. New water should be disinfected and filtered prior to introduction into the system. The use of ultraviolet light (UV) to treat the water in recirculation systems has been recorded in experimental hatcheries for *M. rosenbergii* but is not regarded as being essential for commercial hatcheries.

The pH of the water used in recirculation systems does not usually vary much during the larval cycle but occasionally, especially if the biofilter medium is artificial (non-calcareous), periodical buffering with sodium bicarbonate ( $\text{NaHCO}_3$ ) or sodium carbonate ( $\text{Na}_2\text{CO}_3$ ) may be necessary, as noted earlier. Temperature should be kept steady, not only for the sake of the larvae but also because the biofilters do not operate efficiently if it fluctuates. The biofilters should maintain levels of unionized ammonia, nitrites and nitrates at acceptable levels.

## STARTING YOUR LARVAL BATCH Hatching and stocking larvae

Captive broodstocks are not normally maintained in tropical zones where a ready supply of berried females is available from the wild or from grow-out farms, even though there may be advantages in

doing so, as discussed earlier in this manual. Whether the berried females are obtained from a captive broodstock or from the wild, you should hold them in slightly brackishwater (~5 ppt) at 25-30°C and preferably at pH 7.0-7.2 until the eggs hatch. Slight salinity results in better egg hatchability and recent research (Law, Wong and Abol-Munafi 2001) indicates that careful control of pH markedly enhances the hatching rate (hatchability). Temperatures below 25°C promote fungal growth on the eggs. Temperatures below the optimum also cause some eggs to drop and increase the time for egg development. Temperatures above 30°C encourage the development of protozoa and other undesirable micro-organisms. Light does not seem to affect egg hatchability, although direct sunlight should be avoided. There is no need for you to feed females when they are only being held for a few days simply for larval collection.

You can hatch your larvae in a special broodstock holding system (see Figure 12) and then transfer them to larval rearing tanks in 12 ppt water. In hatcheries operating recirculation systems, newly hatched larvae (Stage I) are often harvested from the broodstock holding tank using a collecting device. If you are operating a simple flow-through hatchery you can place females with brown to grey eggs directly into the larval tanks. Then, remove the females with a coarse dip-net after their eggs hatch. Some hatcheries put the females into coarse-meshed cages within the larval tanks, which makes them easier to remove after their eggs have hatched. When females are put into the larval rearing tank the water level should be about 30 cm and, as noted above, the salinity should be about 5 ppt with a pH of 7.0-7.2. After you have removed the females, raise the water level to the normal level (~70-90 cm) and adjust the salinity to the normal larval rearing level (12 ppt). Egg hatching, which occurs predominantly at night, can be observed by the presence of larvae in the tank and the absence of eggs on the underside of the abdomens of the females. Use a white board (Figure 33) to make it easier to observe larvae.

Freshwater prawn larvae in tanks are difficult to see; using a white board will help

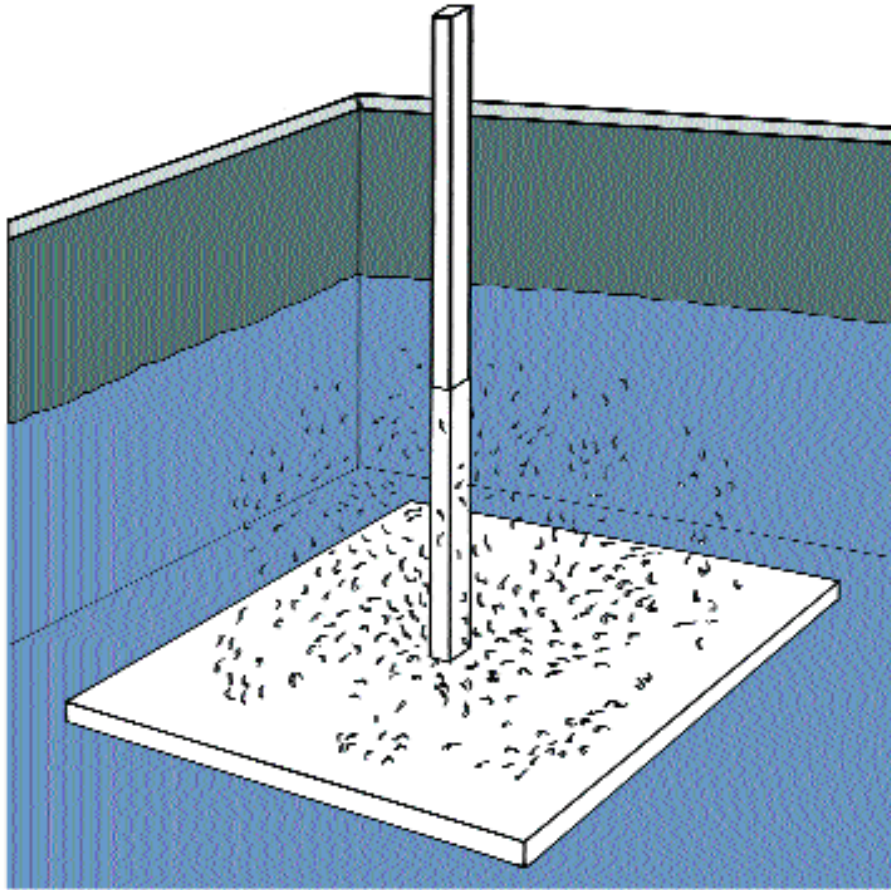

SOURCE: EMANUELA D'ANTONI

The rate at which you stock your larval tanks depends on whether you are going to rear them to metamorphosis in the same tank or if you intend to adjust the larval density by dilution or by transfer to other tank(s). Some hatcheries prefer to maintain their larvae in the same tank from stocking until the harvest of PL. The advantage of this is that the larvae are not subjected to handling. Handling brings with it the dangers of damage to the larvae and physical losses during the transfer operation. Other hatcheries prefer to stock the larvae much more densely at first and then to give them more space to grow by adding more water to the original tank (dilution rearing), or transferring all or some of the animals to other tanks later (two-stage rearing). The advantage of this alternative technique is that it reduces the quantity of water needed for the batch and permits more efficient feeding (the larvae are closer to the feed) during the early larval stages. A compromise between these two systems is possible. Three alternative stocking strategies are therefore suggested in Box 8.

You must select berried females that are all in the same stage of ripeness. This ensures that your larval tank will contain larvae of the same age (within 1-3 days) thus reducing cannibalism and making a proper feeding schedule applicable. You can obtain the

## Alternative larval stocking strategies

### BOX 8

#### REARING THE LARVAE FROM STAGE I TO PL IN THE SAME TANK

If you are going to grow the larvae to metamorphosis in the same tank, stock them into the tank at 60-100 larvae/L.

#### TWO-STAGE REARING

If you are going to give them more space by operating a two-stage rearing method, stock them into the stage 1 tanks at about 500 larvae/L. When they reach the fifth or sixth larval development stage (see Annex 1), which takes about 10 days, reduce the density to about 50 larvae/L by transferring the larvae to other tanks.

#### DILUTION REARING

If you want to avoid the stress caused during the transfer of larvae to other tanks but still make the feeding more efficient and the water consumption less than in the first stocking method listed above, stock the larvae at 100 larvae/L into 35-45 cm of water at first. Then, gradually increase the water level to the normal level (70-90 cm) as the animals grow.

initial stocking rates shown in Box 8 by estimating the number of larvae during transfer from the broodstock system (if you have one). Alternatively, if you are placing berried females directly into the larval rearing tanks, you can make some assumptions. About 1 000 larvae are produced from each 1g of berried female weight. Berried females of 10-12 cm (rostrum to telson) normally carry about 10 000 - 30 000 eggs. However, many eggs are lost through physical damage and cannibalism by the adult females during their transport from rearing ponds or capture fisheries, and some fail to hatch. Therefore, for example assuming that 50% of the original egg clutch is lost, five berried females of this size should be enough to provide a 1 m<sup>3</sup> larval tank with about 50 larvae/L. It is important for you to check your actual stocking density and monitor

the number of larvae you have during the rearing period, as discussed in the next subsection of the manual.

### Counting larvae

Gross mortality during the larval rearing cycle is easily visible; counting the live animals is not necessary to see this. However, it is important for you to estimate the number of larvae you have in your tanks, both at the time of stocking and during the rearing period. This enables you to estimate survival rates, adjust the larval density, control your feeding schedule, and compare the performance of different batches.

You cannot count the number of larvae unless they are evenly distributed in the tank. Thoroughly mix the water in the tank by hand, and take at least 10 samples of a known volume of water (e.g. in 30 ml beakers, or glass pipettes with the ends cut off to give a wider diameter at the tip). Count the number of larvae in each sample. Multiply the average number of larvae/ml by the total volume of water (in ml) in the collection tank. Thus, for example, if the average number of larvae you see in a series of 30 ml beaker samples is 10, the estimated number you have in your tank is  $10 \div 30 \times 1\,000 = 333$  larvae/L. It is possible that automatic counting devices may be applied to freshwater prawn hatcheries in the future but few hatcheries are currently large enough to warrant the investment required.

### ROUTINE WORK

#### Good larval water quality

The exact larval rearing salinity is not as critical as many early hatchery operators used to think. However, you are recommended to keep the larval cycle salinity for *M. rosenbergii*

at 12 ppt [Note: different salinity levels apply to other *Macrobrachium* spp.]. Slight variations in salinity are not detrimental but you must avoid making sudden changes. These could occur, for example, if you used full strength seawater or freshwater instead of brackishwater by mistake. The simplest way to check salinity is by means of a hand-held refractometer.

The optimum temperature range for *M. rosenbergii* is 28-31°C. Below 24-26°C the larvae will not grow well and the time taken for them to reach metamorphosis will be longer. This affects hatchery economics enormously. Temperatures over 33°C generally cause high mortalities. Excessively high temperatures may occur when the water level is kept too low (for example, to conserve water use), especially if the tanks are outdoors and not well shaded. Gradual variation in temperature within the optimal range (such as occurs naturally between night and day or cloud and sunshine, for example) is acceptable, though it should be minimized as far as possible. Sudden changes in temperature, even as small as 1.0°C, shock the larvae and cause mortalities. It is therefore essential to have an adequate stock of prepared 12 ppt water for exchange purposes, maintained under the same environmental conditions as the larval tanks, available at all times. Do not suddenly change the larval water with water that has been in a tank standing in bright sunlight!

Dissolved oxygen levels in larval rearing water should be maintained as close as possible to saturation (Table 7). You will need to turn the aeration system off for short periods (e.g. for observation of the larvae). Double-check that you have turned the air on again immediately after any tank operation in which you have turned it off. One of the major causes of larval mortality is operator error on this point. In practice, if the procedures for water changing, tank cleaning and feeding laid down in this manual are adhered to, and there is no failure in the hatchery air distribution system, no problems should be experienced with low oxygen levels. It is not essential to measure dissolved oxygen levels in the larval rearing water, though it would be preferable to do so if a portable meter is available. This would give you a warning, before the larvae get stressed, that you need to change the water.

### Keeping water quality good

The amount of organic materials, especially suspended solids, should be minimized to prevent the proliferation of heterogeneous bacteria, reduce biological oxygen demand, and prevent stress to the broodstock and larvae. Clean the tanks by siphoning excess food and waste as often as needed. Many invisible changes in the chemical water quality of larval-rearing water occur. These are due mainly to the metabolic wastes produced by the larvae themselves (and by live feeds) and by the degradation of excess food. Some of these changes can be extremely harmful to larvae. The most serious are increases in the non-ionized<sup>8</sup> form of ammonia (NH<sub>3</sub>), which is especially evident at high pH and temperature, and in nitrite. It is beyond the scope of this manual to deal with water chemistry but those who wish to study this matter should consult the review by Valenti and Daniels (2000), which also contains references to other publications on this topic.

If you are running a hatchery based on the flow-through 'clearwater' system, there is no substitute for frequent water exchange. Recommended procedures to maintain good larval water quality in flow-through systems are given in Box 9. Further recommendations on system hygiene are made later in this manual.

### Special considerations for recirculation systems

Routine care is even more essential in recirculation than in flow-through hatcheries, espe-

---

<sup>8</sup> Ionised ammonia is referred to as NH<sub>4</sub><sup>+</sup>



## Recommendations for good larval water quality

**D** **O NOT OVERFEED.** Maintain good hygiene and clean the inner surfaces of the tanks every two days by means of a 'squeegee' or scraper.

Turn off the air supply to allow solid particles to settle, and siphon off (Figures 34a and 34b) surplus food particles and metabolic wastes from the bottom of the tank. Do this daily, immediately before one of the feeding operations. Keep the time taken to complete this task to a minimum and turn the air on again as soon as possible. Make this part of the daily water exchange procedure. Siphoning will also remove any mortalities which have occurred. This provides you with a good opportunity to observe the condition of your larvae.

There is no great danger of losing healthy animals while siphoning because the larvae swim in the body of the water and do not crawl. There may be some live larvae on the bottom of the tank and these may pass through the siphon tube. Some hatchery operators collect these (Figure 35) and return them to the larval tank. You are not recommended to do this. Discard these larvae because they are probably too weak to evade the oncoming siphon tube and are therefore of poor quality.

Never hesitate to exchange the larval water (in addition to routine water exchange, see below) at any time you suspect that the water is poor. Poor water quality (due, for example, to excessive overfeeding) can be detected if the dissolved oxygen level is low, if the water appears turbid and/or smells foul, or the animals appear in 'poor condition'. Larvae in 'poor condition' are sluggish, not active. They do not appear to be strong enough to swim against the air bubbles, are found only at the edges of the tank, and sometimes jump out of the tank. Non-feeding larvae can be detected by their colour. Normally they should be brownish, due to the consumption of brine shrimp nauplii. If you are worried about poor water quality, immediately change most of the water, taking care to replace it with water of the correct salinity and temperature. Operate the turn-down drain until the water depth is only about 10 cm, flush the tank with 'new' water for 10-15 minutes and then fill up to 70 cm again. The 'new' water used for flushing and replacement must be pre-aerated, 12 ppt salinity, and the same temperature as the 'old' water, and the tank aeration system must be kept on

throughout the operation.

Regularly exchange some of the water in the tank, according to its quality (see above). You should not have to change it during the first three or four days of the larval rearing cycle. Then, as you begin introducing inert food, exchange 50% of the water every day, or every second day, according to its quality. You may find it necessary to increase the exchange rate to over 50% per day toward the end of the rearing cycle, when biomass and feeding levels are at their greatest. Decrease the water level from 70 cm to about 35 cm, partly through the siphoning operation described above, and partly by use of the turn-down drain. Replace the water removed with ready-mixed, aerated, 12 ppt water at the same temperature as that already in the larval tank. Do this operation before feeding, so that food will not be wasted.

You may find it useful to follow the practice of some freshwater prawn and marine shrimp hatcheries that maintain 10 ppm of the sodium salt of ethylene diaminetetraacetic acid (EDTA) in the larval rearing water, believing it to improve productivity because of its chelating ability (see glossary – Annex 11).

cially when the filtration system is new. Despite this, those familiar with recirculation systems claim that the amount of labour required is not greater than in flow-through systems. Following the suggestions of Valenti and Daniels (2000), a routine maintenance schedule for recirculation systems is suggested in Box 10. Further recommendations on system hygiene are made later in this manual.

# FIGURE 34a

Tanks need regular siphoning to remove faeces, the larval exoskeletons that are cast off during moulting, and waste food

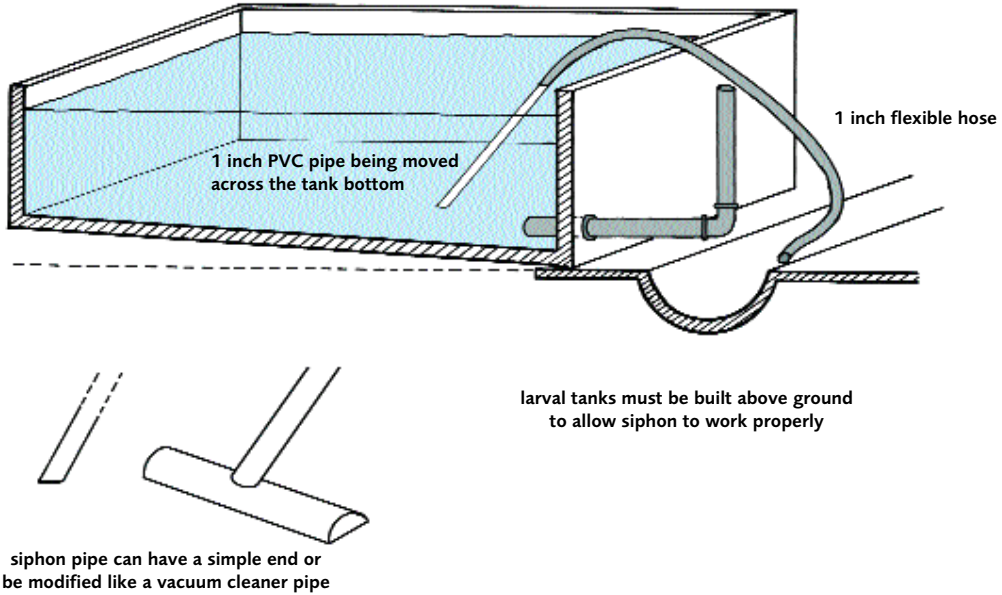

SOURCE: EMANUELA D'ANTONI

**Figure 34b**  
Good tank hygiene is essential for hatchery success (Hawaii)



SOURCE: SPENCER MALECHA

A detailed description of a recirculation freshwater prawn hatchery is provided in Daniels, D'Abramo and Parseval (1992) and Fuller, Kelly and Smith (1992). Further reading is provided in Valenti and Daniels (2000). A simple recirculation system is described in Chowdhury, Bhattacharjee and Angell (1993).

## FEEDING

A wide variety of feeds are employed by different hatcheries, including the nauplii of brine shrimp (*Artemia* spp.), a freshwater cladoceran (*Moina* spp.), fish eggs, squid flesh, frozen adult *Artemia*, flaked adult *Artemia*, fish flesh, egg custard, worms and commercial feeds. This freshwater prawn manual describes only one feeding regime in detail, which has been found

to be effective. However, many alternative feeding systems exist and the readers of this manual may wish to experiment with locally available feeds. Those who wish to consider

# FIGURE 35

Many of the larvae that go missing during the larval rearing cycles are not mortalities but are lost through operator error. For example, it is easy to lose larvae during water changing and tank cleaning. Losses can be minimized by filtering the water removed from tanks and returning the live larvae, if healthy

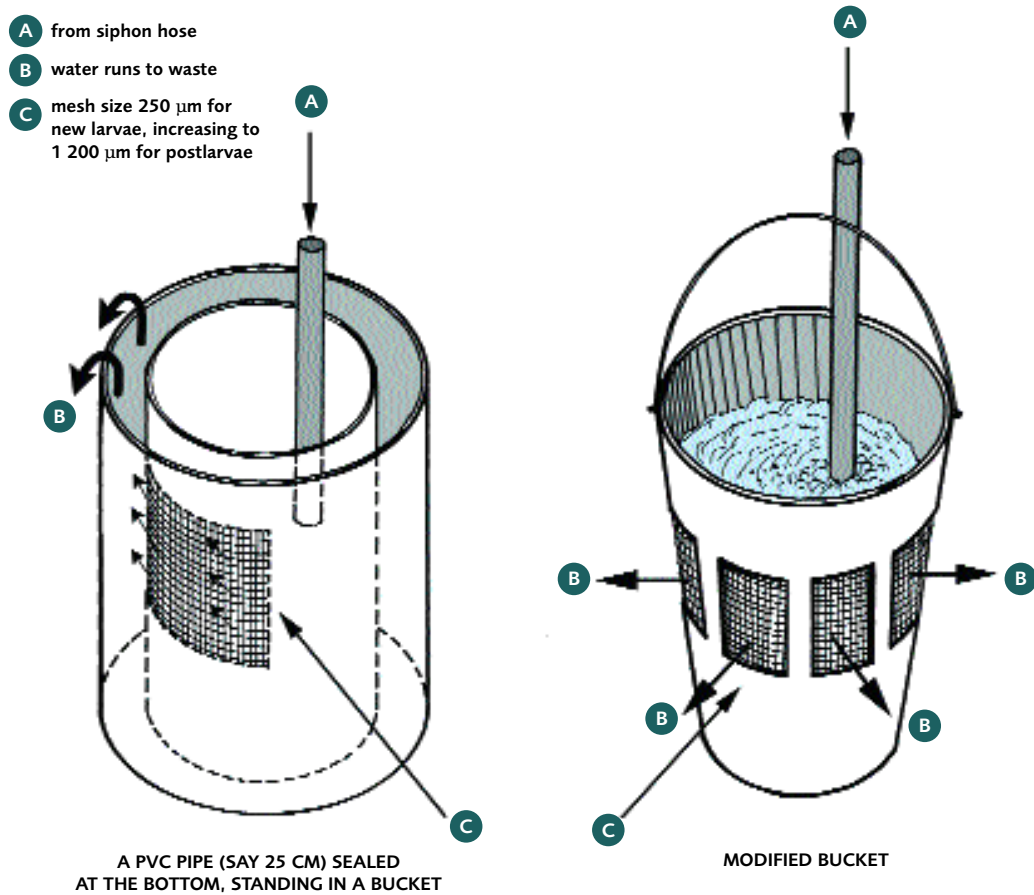

SOURCE: EMANUELA D'ANTONI, AFTER NEW AND SINGHOLKA (1985)

the use of alternative live foods are recommended to obtain another FAO manual (Lavens and Sorgeloos, 1996), which includes sections on the culture and use of rotifers (e.g. *Brachionus plicatilis*) and cladocerans (e.g. *Moina* spp.), as well as *Artemia*, in aquaculture hatcheries. Useful information on live food production is also contained in another FAO publication (Moretti, Pedini Fernandez-Criado, Cittolin and Guidastrì, 1999), which describes the use of rotifers and *Artemia* in marine finfish hatcheries.

Two feeds are used in the feeding system described in this manual, namely brine shrimp nauplii (*Artemia* nauplii, referred to subsequently as BSN) and prepared egg custard feed (hereafter called EC). Methods for preparing these feeds before use are given in Annex 4 (BSN) and Annex 5 (EC). BSN are small crustacean nauplii hatched from cysts which can be bought in vacuum packed bags and cans. An example of a feeding schedule is given in Table 8.

## Maintenance schedule for recirculation systems

### IN THE MORNING:

- ⊙ **MONITOR** the system, checking water temperature, water level and water flow.
- ⊙ **CLEAN** the screens and check if they need changing.
- ⊙ **REPLACE** water losses with water that has been properly processed and stored (this avoids 'shocking' the larvae or the bacteria of the biofilter by adding water of different composition, salinity or temperature).
- ⊙ **MONITOR** the mechanical filters and clean if necessary.
- ⊙ **FEED** the larvae according to the normal schedule and then stage (see Annex 1) and monitor their progress and health.
- ⊙ **HARVEST** your *Artemia* nauplii and store (see Annex 4, Table 4) excess quantities for future use.
- ⊙ **PREPARE** a new batch of *Artemia* cysts for hatching.

### IN THE AFTERNOON:

- ⊙ **SCRUB** the bottom and sides of the tanks to remove all algae and organic debris. Keep the aeration going while you do this so that larvae do not become trapped between the mop and sides or bottom of the tank.
- ⊙ **TURN** the aeration and water flow off and siphon the visible waste from the larval tanks. Make sure you turn the aeration and water back on!

- ⊙ **CHECK** the siphoned waste (see Figure 35) for dead larvae. Count the number of dead larvae and subtract this from the number stocked, or the number estimated the previous day. Remember that this will be an underestimate because of cannibalism on dead or weak larvae. Your estimates will not be accurate but making them helps you to look out for increasing levels of mortality or acute problems. In well-managed recirculation hatcheries, survival is normally better than in flow-through hatcheries (partly, perhaps, because fewer animals are lost but mainly because the water quality is more stable).

- ⊙ **MEASURE** ammonia and nitrite levels (the frequency of these tests may be reduced to two or three times per week once the system is stable).

- ⊙ **SEE** if there is any decrease in food consumption (this would be an indicator of bacterial or water quality problems). If microbiological facilities are available the bacterial concentration of the water could also be monitored.

### EVERY SECOND DAY:

- ⊙ **DISINFECT** all small equipment, such as beakers, porous air stones, hoses, buckets, etc., with 5 ppm/L active chlorine solution, rinse thoroughly with freshwater, dry, and store.

Most freshwater prawn larvae do not feed on the first day (hatching day). However, you are recommended to provide some BSN in the late afternoon of the first day because some larvae begin to eat early. From day 2 until day 4, feed BSN five times per day, with the last and main feed in the evening. After that, you can gradually reduce the number of BSN feeds per day until, by day 10, you are only giving BSN at the evening feeding time. The evening meal should be given as late as possible (18.00-19.00). The amount of BSN you give at each feeding time depends on your visual examination of the larval water. Freshwater prawn larvae do not actively search for food, which is why BSN (which swim actively in the same part of the water column as the larvae) are such a valuable feed type. The ideal is therefore to have BSN always present in the tanks in sufficient numbers for the larvae to 'bump' against. The amount of BSN required at any one time depends pri-

# 8

TABLE

## Hatchery feeding schedule

LARVAL AGE (DAYS)	LIVE FEED (BSN)		PREPARED FEED (EC)
	NUMBER OF DAYTIME FEEDS (0700-15.00)	ADDITIONAL LATE AFTERNOON FEED	NUMBER OF MEALS BETWEEN 0700-15.00 (NO LATE AFTERNOON FEED)
1	None	Yes	None
2	4	Yes	None
3	4	Yes	1
4	4	Yes	2-3
5	3	Yes	4
6	3	Yes	5
7	2	Yes	5
8	2	Yes	5
9	1	Yes	5
10-PL	None	Yes	5

NOTE: BSN = BRINE SHRIMP NAUPLII; EC = EGG CUSTARD BASED DIET. THE QUANTITIES TO BE FED ARE DISCUSSED IN THE RELEVANT SECTION OF THE MANUAL.

marily on the tank volume, not on the number of larvae present, although the latter of course controls the rate at which BSN are consumed. This concept is clearly illustrated in Box 11.

As a guide, there should be about 3-6 BSN/ml directly after feeding, depending on the age of the prawn larvae, and 1 BSN/ml left in the water just before the next BSN feeding time. If there is more than 1 BSN/ml at the latter time then you have been overfeeding or the larvae are not feeding well. If there is less than 1 BSN/ml, you should add more

this time than last time. A density of 3-6 BSN/ml in a tank with 5 m<sup>3</sup> of water means that 15 to 30 million BSN have to be added. The quantity of brine shrimp cysts ('eggs') necessary to produce 1 million BSN depends on the source and quality of brine shrimp cysts used and the preparative treatment they are given; it is usually stated on label of the cans. As a rough guide, however, you can assume that 75 to 150 g of *Artemia* cysts will be required to produce the 15 to 30 million BSN required for the daily feeding of a 5 m<sup>3</sup> larval tank initially stocked with 50 larvae/L and expected to provide about 25 PL/L. Normally one larval cycle in this size of tank will consume 1.25-2.5 kg of brine shrimp eggs.

### Feeding BSN depends on tank volume, not the number of larvae in it

#### BOX 11

- ⊙ Suppose that each freshwater prawn larva consumes 50 BSN/day.
- ⊙ Suppose that you have 150 000 larvae in one of your tanks.
- ⊙ You would therefore need 50 x 150 000 = 7.5 million BSN/day to provide sufficient food.
- ⊙ However, suppose you only have one larva in another of your tanks.
- ⊙ Would you only put 50 BSN into the tank and would the larva find them? **No!**
- ⊙ This demonstrates that it is the density of the BSN that matters, not the total quantity.

By day three, you can start feeding tiny quantities of EC, gradually increasing the feeding frequency to five times per day, spread out evenly throughout the day. Give the last feed of EC about 15.00. Do not give EC for the final late afternoon feeding because the quantity necessary to supply the requirement throughout the night in one feeding would foul the water; use BSN only. From day 5 you are starting to reduce the frequency of feeding BSN and by day 6 you should be feeding EC about 5 times per day. Continue feeding at this frequency throughout the rest of the larval cycle. After day 10, you need only give BSN at the evening feeding, to ensure the presence of food during the night. By this time you should be using very much greater quantities of EC at each feeding time.

The exact quantity of food to be given at each meal cannot be prescribed because it depends on the utilization of the feed by the larvae. You must judge this visually. The quantity of EC feed consumed will increase as the larvae grow. The basic rule is that each larva should be seen to be carrying a particle of EC immediately after every EC feeding. Use EC particles of about 0.3 mm in size up to larval day ten; from then until metamorphosis use 0.3-1.0 mm particles. The particles of EC must be kept close to the larvae; this is an additional reason for ensuring vigorous aeration in larval tanks. Underfeeding will lead to starvation, cannibalism and slow growth; overfeeding (especially if large quantities of EC are obvious before the next feeding time commences) will cause water pollution. Pollution through overfeeding is obvious through the presence of EC particles before the next feeding or if there is a lot of 'foam' or 'scum' on the water surface. Should water pollution occur by error, the water must be immediately exchanged, as explained earlier in this manual. As a very approximate example, you should expect to use about 7.5 kg of EC for every larval cycle in a 5 m<sup>3</sup> tank initially stocked with 50 larvae/L. Initial quantities of EC at day five for this size of tank and stocking density would be about 25 g/tank at each feed and will rise to around 100 g/tank/feed.

An alternative feeding regime is presented in Table 9. In this system, the BSN and EC feeds are supplemented with a commercially available inert feed. The use of supplemental feed not only tends to reduce feeding costs but is thought to compensate for nutritional deficiencies in *Artemia* nauplii. However, the nutritional quality of the *Artemia* can be increased by enrichment (Annex 4).

The general recommendations in this section of the manual apply also to recirculation systems but all hatcheries have their own feeding regime variations. For example, some hatcheries that use recirculation systems turn off the water flow system during feed-

TABLE **9** Alternative hatchery feeding schedule

LARVAL STAGE	TIME				
	07:00	10:00	11:00	13:00	16:00
I to IV	BSN	-	BSN	-	BSN
V	BSN	-	ID/EC	-	BSN
VI until PL	ID/EC	ID/EC	-	ID/EC	BSN

**NOTE:** BSN = BRINE SHRIMP NAUPLII; ID = INERT DIET; EC = EGG CUSTARD BASED DIET. THE INERT FEED USED IN THIS FEEDING REGIME WAS LANSY MB (INVE AQUACULTURE NV., B-9080 LOCHRISTI, BELGIUM). THE MANUFACTURERS CLAIM THAT ITS USE ENABLES 40% OF THE BSN AND 70% OF THE EC TO BE REPLACED. LANSY MB IS THE FIRST STEP IN THE DEVELOPMENT OF A COMPLETE ARTEMIA REPLACEMENT DIET.

**SOURCE:** DERIVED FROM CORREIA, SUWANNATOUS AND NEW (2000)

ing to avoid BSN leaving the tank. Others use small-mesh screens (90 to 150 µm) to avoid losses of BSN in the biofilter.

## HYGIENE, HEALTH AND MANAGEMENT PROBLEMS

### Good hygiene

Good hygiene is essential for hatchery success. Ideally, you should not use the same equipment for more than one tank. Thus each tank would have its own dedicated nets, siphon tubes, spare filters, etc. This is time and money consuming and rarely practised. However, some much more important guidelines must be followed.

Water should never be transferred from one larval tank to another. Submersible pumps, which are often used for water transfer in hatcheries, should never be placed in the larval tanks because they are a potential source of disease transfer. Always drain your larval tanks by gravity or siphon and only use submersible pumps in water storage or mixing tanks. Disinfect all mobile equipment (buckets, siphoning tubes, nets, beakers, pipettes, etc.) on a daily basis. Dip them in a 500 ppm active chlorine solution<sup>9</sup>, rinsing them very thoroughly with water and storing them dry. Between larval rearing cycles, routinely disinfect the larval tanks. Failure to do this usually results in massive blooms of organisms, such as *Zoothamnium*, *Epistylis*, hydroids, etc., which are harmful to the larvae. Disinfection does not eradicate these organisms but does effectively control their growth. Scrape your tanks between larval cycles, fill them with a 500 ppm active chlorine solution for one day, rinse them very thoroughly with water, dry them in sunlight for one day, and rinse them thoroughly again before use.

Good hygiene and management standards are even more essential in recirculation than in flow-through hatcheries. Mistakes lead to larval mortalities. Before use, immerse all new tanks, filter containers and filter media, and every other piece of hatchery equipment in running freshwater for one or two weeks to eliminate potentially toxic substances. Then clean and flush the system with filtered freshwater prior to filling it with brackishwater. After filling the system with brackishwater, disinfect it by adding 5 ppm of available chlorine (see Box 6) a few days prior to stocking. Run the whole system normally, including the filter, providing aeration; this should remove all the residual chlorine in a few days. It is possible to do this more quickly by using sodium thiosulphate but this is not recommended, because of the problems noted earlier in this manual. Ozonisation or UV light can be employed to avoid the use of either chlorine or thiosulphate but, of course, these add to the capital costs and have not yet been noted in commercial freshwater prawn hatcheries. Some additional recommendations for hygiene in recirculation systems are given in Box 12.

### General management problems

Most hatchery problems are caused by poor management. The commonest cause of larval loss is not mortalities due to poor water quality or disease, but physical losses due to simple operator error during tank cleaning and siphoning, water exchange, etc. Poor internal (i.e. within the hatchery) water quality is usually caused by poor management, for example: inadequate water exchange, poor daily observation of the larvae, overfeeding, total failure of the aeration equipment due to poor maintenance of the blower or emergency

---

<sup>9</sup> Both dry and liquid sources of chlorine vary considerably in their chlorine content from product to product and from batch to batch. It is best to determine the level of chlorine in each batch before use, to ensure that you are actually using the quantity of chlorine that you think you are adding. The methods for determining the level of chlorine in commercial bleaching powder or liquid bleach are contained in Annex 4, Table 6. The method for making a 200 ppm active chlorine solution is given in Annex 4, Table 3; to make a 500 ppm active chlorine disinfecting solution, use 2.5 times the quantity of liquid bleach or bleaching powder calculated from that table.

## Additional recommendations for recirculation system hygiene

BOX 12

- **PREVENT** the introduction of disease organisms or chemical contaminants by workers and visitors entering the hatchery by using chemical footbaths, and washing hands prior to and when returning to work.
- **KEEP** all equipment, supplies, and food clean at all times. Special care should be taken before a new larval cycle is begun.
- **AVOID** disease transfer by using equipment for only one recirculation system. Keep another set for each system.

power supplies, or individual tank aerators being blocked or left turned off. Losses also occur because late-stage larvae (close to metamorphosis) jump quite a lot and some get stranded above the water line. Some hatcheries cut out a strip of mosquito screen and stick it to the inside of the tank with epoxy-resin in the region of the water surface level. Since the water level varies it is suggested that the strip of mosquito netting should be about 12 cm wide. This helps to prevent larvae becoming stranded.

It cannot be over-stressed that while this manual attempts

to lay down guidelines for a particular method of freshwater prawn culture, successful hatchery operation is a blend between factory discipline and husbandry. The most important thing to remember is that if you do not pay close attention to your animals, your hatchery will fail. You and your staff must always closely observe the behaviour of your larvae and the condition of your tanks.

### Problems of disease and predation

Several diseases affect freshwater prawn larvae. These are summarized within Table 10. Some preventative measures are listed in Table 11. More information is provided in Johnson and Bueno (2000). If you see problems which may be caused by disease you should seek the advice of local aquatic animal health specialists (where available) and microbiologists for identification and treatment purposes. Some brief notes are provided in Box 13. Some hatcheries use formalin (200-250 ppm daily dip for 30 min) as an effective remedy for protozoal and hydrozoan infections and fungal diseases. Where the treatment period is short it is best to apply it when the tank water level is very low (10-15 cm) so that it can be rapidly flushed with 'new' 12 ppt water after treatment. The flushing process should continue for one hour. Aeration must continue during treatment as normal. Formalin can also be used at a lower level of 25-30 ppm for a longer period, followed by a water change after 24 hours. Mortalities from hydroid infestation can also be reduced by transferring healthy larvae to newly disinfected tanks every 5-10 days. Malachite green (0.2 ppm daily dip for 30 min) has also been used for treatment. However, you are recommended not to use this substance because it may be toxic to hatchery workers; its use is banned in some countries. Similarly, the use of copper sulphate (previously suggested as a 0.4 ppm dip for 6 hours) is not now recommended. Antibiotics are sometimes used to control filamentous bacteria (*Leucothrix* spp.).

Some hatcheries use lime (CaO) as a prophylactic between larval cycles. Others apply antibiotics and/or sulpha drugs as prophylactics but this practice is definitely not recommended in this manual, partly because their use in aquaculture may become banned in future and partly because of the danger of inducing the development of resistant disease strains. The use of these and other treatments for disease problems is described in Johnson and Bueno (2000).



TABLE 10 | The major diseases known to affect freshwater prawns, and their exterior symptoms

VIRUS DISEASES	BACTERIAL AND RICKETTSIAL DISEASES	FUNGAL DISEASES
<p><b>Macrobrachium hepatopancreatic parvo-like virus (MHPV):</b> none; not associated with significant morbidity or mortality.</p>	<p><b>Black spot (sometimes called brown spot or shell disease):</b> one or many melanized lesions on the cuticle; often caused by opportunistic bacteria which enter following physical damage; problem may disappear at the following moult but sometimes develops into deep spreading lesions; reduces marketable value of harvested prawns.</p>	<p><b>Lagenidium infection:</b> affects larvae: an extensive mycelial network can be seen through the exoskeleton; can decimate hatchery populations within 24 hours.</p>
<p><b>Macrobrachium muscle virus (MMV):</b> muscle tissues become opaque, followed by necrosis; occurs within 10 days of stocking PL and may cause up to 50% mortality.</p>	<p><b>Appendage necrosis:</b> larval appendages become necrotic and melanized; affected larvae do not eat and may become bluish in colour; may be associated with a heavy surface burden of the filamentous bacterium <i>Leucothrix</i>.</p>	<p><b>Infections by <i>Fusarium</i> and <i>Saprolegnia</i>:</b> cause necrosis and melanization; follow physical damage.</p>
<p><b>White spot syndrome baculovirus (WSBV):</b> targets the cuticular epidermis, stomach, gills and hepatopancreas; important disease in marine shrimp; <i>Macrobrachium</i> is known to be a carrier but it is not yet certain whether WSBV causes mortalities in freshwater prawns.</p>	<p><b>Internal infections:</b> caused by a variety of Gram negative bacteria such as <i>Vibrio</i> spp. and <i>Aeromonas</i> spp.; feeding discontinues; discolouration of the body (usually pale and white) occurs; animals listless; infections by luminous vibrios are usually serious.</p>	<p><b>Yeast infections:</b> muscles appear yellowish, bluish or grey; causes heavy mortalities in grow-out ponds; particularly prevalent when temperatures are lower than optimal and organic matter is allowed to accumulate and eutrophication occurs.</p>
<p><b>Nodavirus (MRNV):</b> opaque whitish appearance of the abdomen, followed by severe mortalities.</p>	<p><b>Bacterial infection caused by <i>Enterococcus</i>:</b> necrosis in muscles and hepatopancreas; begins in the head portion and proceeds to the tail; animal appears opaque; exacerbated in high temperature (33-34°C) and high pH (8.8-9.5) conditions.</p> <p><b>Rickettsial disease:</b> larvae become white throughout their bodies and generally inactive before death; infected populations experience significant mortalities.</p>	

**NOTE:** THIS TABLE DESCRIBES THE EXTERIOR SYMPTOMS AND THOSE THAT CAN BE SEEN BY SIMPLE MICROSCOPIC EXAMINATION. DISEASES DETECTABLE BY OTHER TYPES OF INVESTIGATIONS ARE MENTIONED IN THE ORIGINAL REVIEW (JOHNSON AND BUENO, 2000)

As noted earlier in this section, severe disease problems very frequently begin because of basic management failure. Such failures will be minimized if you follow the recommendations in this manual. However, diseases will still sometimes occur. You are recommended to totally discard any seriously infected batch, to drain the tanks, and to disinfect all the hatchery equipment. Do not waste time on treating a serious infection. Cut your losses, try to find out the basic cause of the problem, eliminate it, and start a new larval batch.

TABLE **11** | Prevention and treatment\* of freshwater prawn diseases

DISEASE	PREVENTION AND TREATMENTS* REPORTED IN THE LITERATURE ON PRAWN DISEASES
<b><i>Macrobrachium</i> hepatopancreatic parvo-like virus (MHPV)</b>	Obtain and maintain disease-free stock; good management. No treatment reported.
<b><i>Macrobrachium</i> muscle virus (MMV)</b>	Obtain and maintain disease-free stock; good management. No treatment reported.
<b>White spot syndrome baculovirus (WSBV)</b>	Obtain and maintain disease-free stock; good management. No treatment reported.
<b>Nodavirus (MRNV)</b>	Obtain and maintain disease-free stock; good management. No treatment reported.
<b>Black spot (sometimes called brown spot or shell disease)</b>	Good management, especially maintaining good water quality and avoiding physical damage by handling (by transfer, sampling) or by other prawns (may be caused by over-stocking, poor feeding, etc.). Treatment by immersion in 10 ppm oxolinic acid for 1 hour, or 2 ppm nifurpirinol for 96 hours reported.
<b>Appendage necrosis</b>	Good management, especially maintaining good water quality and avoiding physical damage by handling (by transfer, sampling) or by other prawns (may be caused by over-stocking, poor feeding, etc.). Treatment by 0.65-1.0 ppm erythromycin or 2 ppm of a penicillin-streptomycin mixture, or 1.5 ppm chloramphenicol reported.
<b>Internal infections</b>	Good management, especially good filtration and/or treatment of incoming hatchery water. Treatment by 2 ppm chloramphenicol combined with 2 ppm furazolidone for 5-7 days reported.
<b>Bacterial infection caused by <i>Enterococcus</i></b>	Good management, especially by avoiding constructing farms in areas where (or operating farms at times when) temperature and pH are too high. No treatment reported.
<b>Rickettsial disease</b>	Obtain and maintain disease-free stock; good management; treatment of tanks and equipment with lime (CaO) before stocking. Treatment by application of 10 ppm oxytetracycline combined with 10 ppm furazolidone reported.
<b><i>Lagenidium</i> infection</b>	Good management. Treatment by maintaining 10-100 ppb trifluralin in hatchery tanks, or treatment with 20 ppm of Merthiolate® has been reported.
<b>Infections by <i>Fusarium</i> and <i>Saprolegnia</i></b>	Good management, especially maintaining good water quality and avoiding physical damage by handling (by transfer, sampling) or by other prawns (may be caused by over-stocking, poor feeding, etc.). No treatment reported.
<b>Yeast infections</b>	Good management, especially the avoidance of lower than optimal water temperatures and the accumulation of organic matter and eutrophication; use better water exchange, aeration and circulation and lower feeding rates. No treatment reported.

\* ALTHOUGH THESE TREATMENTS HAVE BEEN REPORTED IN THE SCIENTIFIC LITERATURE, THEY ARE NOT RECOMMENDED IN THIS MANUAL. IF SEVERE INFECTIONS OCCUR, POPULATIONS SHOULD BE DESTROYED AND SYSTEMS DISINFECTED AND DRIED OUT BEFORE RE-USE.

SOURCE: JOHNSON AND BUENO (2000)

## Notes on potential disease problems

**M**ANY DISEASE problems are often secondary to, or aided by, a primary failure in tank hygiene, insufficient water exchange, inadequate feed quality, an inappropriate feeding regime, and low dissolved oxygen levels. All these result in poor larval condition.

Protozoa are a common cause of larval 'disease'. The most common belong to the genera *Epistylis*, *Zoothamnium* and *Vorticella*. These protozoa move about and attach themselves to the body surface and the gills of the larvae. They are normally cast during the moulting process but can seriously affect larval movement, feeding, and gill operation. They are also often evident on tank surfaces. Ciliates feed on bacteria and the link with poor tank maintenance is obvious.

The medusan stage of small hydrozoans has been reported to actively prey both on brine shrimp nauplii and freshwater prawn larvae. Problems with hydrozoans are particularly acute when surface water

sources are used. The importance of using ground water and, if this is unavailable, proper water treatment is therefore emphasized.

Bacterial infections take several forms. The first are chitinolytic bacteria, which erode the surface of the exoskeleton, often following physical damage, and appear as black or brown spots or lesions (sometimes referred to as shell disease) or can cause loss of appendages. These moderate to mild occurrences are infrequent and rarely fatal and often disappear when larvae moult. More advanced bacterial involvement of the exoskeleton and underlying tissues may cause high larval mortality from bacterial necrosis. Bacteria, especially of the filamentous type, may also settle on the surfaces of the gills and interfere with respiration. Internal infections arising after pathogenic bacteria enter via the exterior surfaces or digestive tube may also cause serious disease. Damage is done throughout the body or principally in organs such as the digestive gland.

The muscles of larvae subjected

to stress or low oxygen levels sometimes become opaque or whitened and often recover if the exterior problem is cured. This syndrome has been associated with excess sunlight but may indicate advanced disease by viral or other pathogens.

Several viruses have been reported to affect freshwater prawns but not all have yet been associated with morbidity or mortality. Most virus problems have occurred during grow-out. However, in the late 1990s heavy mortalities in some Caribbean *Macrobrachium* hatcheries were attributed to a nodavirus. The visible symptom was a whitish tail.

Fungal infections of larvae may be eliminated by better food hygiene and a reduction in larval density but have caused serious problems in *Macrobrachium* hatcheries, notably in Taiwan Province of China. The fungal infection experienced in the latter hatcheries could be easily identified by the presence of a mycelial network, which could be observed through the exoskeleton (shell) of sick or dead larvae.

An important disease in *M. rosenbergii* hatcheries, whose exact cause is unknown, is referred to as the 'mid-cycle disease' (MCD). As its name indicates, it is most noticeable in the middle of the larval rearing period (days 15-22 when the larvae are at stage VI-VII), when heavy daily mortalities may occur. Mortalities may even start to become obvious as early as day 10. The disease is recognisable by the larvae becoming bluish-grey and swimming slowly in a spiralling pattern, as well as by a reduced rate of consumption of *Artemia* and poor growth rate. You can reduce the incidence of this disease by cleaning, disinfecting and drying out hatchery equipment between cycles and taking special care in general hygiene throughout the larval cycle. If there is a severe outbreak of this disease, a full clean-up of the hatchery should be considered. This would mean killing all the larvae and

thoroughly disinfecting the whole hatchery installation, so it is not a decision to be taken lightly.

Another disease which has mainly been noted to affect larvae is known sometimes as the 'exuvia entrapment disease' (EED) or as the 'moult-death syndrome' (MDS) or as the 'metamorphosis moult mortality syndrome'. The characteristic of this disease is that the larvae get trapped in the old exoskeleton (exuvia) during moulting. It is mostly noticed towards the end of the larval rearing cycle, especially at the moult which occurs when stage XI metamorphoses into the PL stage. The mortality rate at this point can be very high. The cause of EED is not known; it may have multiple causes. It may imply that the diet is nutritionally inadequate and requires enrichment. Difficulties in shedding the old exoskeleton during moulting have also been observed in juvenile and adult prawns. The moulting process is stressful and may be difficult for weakened animals, and it is at this time that hidden problems become noticeable.

## MONITORING PERFORMANCE

Many hatchery operators judge when to make changes in the feeding regime, for example, by the number of days that have elapsed since the larvae were stocked. This is satisfactory if a larval batch is performing well and you are basing your management on previous experience. You can judge the progress of your larvae more accurately by stereoscopic microscopic examination. You should do this on a daily basis until the first PL appear in the tank. A key to the various larval stages is provided in Annex 1.















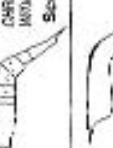



You will very quickly become able to gauge whether your larvae are feeding and growing well by crude visual examination, using a white sight board (Figure 33) and observing the behaviour of the larvae. Healthy larvae swarm at the surface of the water (especially in the first 10 days) when the aeration is turned off, feed actively, have a red-brownish pigmentation, and are not observed to cannibalize. Unhealthy larvae accumulate at the bottom of the tank and are often bluish in colour. Food consumption drops and, if the problem is already severe, you will see dead larvae. Healthy larvae swim tail first, head down and ventral side up. Metamorphosis to PL is characterized by a radical change in behaviour and appearance; for the first time the animals resemble miniature adult prawns and, instead of swimming freely in the water, many crawl or cling to the tank surfaces.

The performance of freshwater prawns during the grow-out phase depends on the history of the PL or juveniles stocked. It is therefore important, if your hatchery is to establish and maintain a good reputation for high-quality PL, to monitor the condition of your animals. A new method to score the condition of *M. rosenbergii* larvae was developed by Tayamen & Brown (1999). This is based upon microscopic examination, followed by scoring on a condition index using a numerical scale. Larvae scoring high on this system have been demonstrated to show better growth and survival in various Southeast Asian hatcheries. The scoring system is illustrated in Figure 36a and a larval quality record sheet in Figure 36b.

Although survival rates of up to 80% between stage I and metamorphosis to PL have been claimed by some hatcheries, 40-60% is more normal in practice. The time taken for a larval batch to metamorphose varies according to feeding and environmental conditions, particularly temperature. In a healthy, well-fed batch, which is maintained within the optimum temperature range, you should expect to see the first few PL between days 16-20 after stocking. Most of the larvae should have metamorphosed into PL by days 25-32 at the recommended water temperature of 28-31°C. Some hatchery operators wait for the last few larvae to metamorphose before harvesting but it is not usually economic to maintain any batch longer than 32-35 days (by which time 90-95% metamorphosis should have

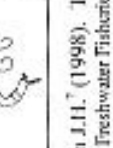
A method of evaluating the quality of *Macrobrachium rosenbergii* larvae is illustrated in this diagram

Explanatory glossary for condition index \*

1	GUT FULLNESS		GUT FULL WITH LOCAL STAINING Score 2		GUT FULL WITH LOCAL STAINING Score 2
2	GUT LIPID CONTENT (STATE OF HEPATOPANCREAS)		GUT EMPTY OF FOOD Score 0		GUT AREA EMPTY FULL Score 1
3	PIGMENTATION (STATE OF CHROMATOPHORES)		FAIRLY CONTRACTED CHROMATOPHORES ASSOCIATED IN ONE AREA (NOT COLONIAL) Score 0		WELL DISPersed CHROMATOPHORES WARRANTY/STAINING IN VARIOUS Score 2
4	BODY COLOURATION		GREYISH-BLuish APPEARANCE IN ABDOMINAL SEGMENT Score 0		MODERATE LIGHT CHANGE APPEARANCE IN ABDOMINAL SEGMENT Score 1
5	SETATION		REGULAR DIAMOND SHAPED DISTURBED (check setae also) Score 0		REGULAR STRAIGHT WHOLE (check setae also) Score 2
6	MUSCLE TO GUT RATIO		GUT APPEARS THIN MUSCLE THIN IN V. SEGMENT Score 0		GUT APPEARS THIN MUSCLE IN VI. SEGMENT INFER Score 2
7	MUSCLE APPEARANCE OF ABDOMEN (APPEARANCE ABNORMAL MUSCLES)		ABDOMINAL MUSCLE FIRM/STAINING Score 0		ABDOMINAL MUSCLE CLEAR TRANSPARENT, SMOOTH Score 2
8	MELANIZATION (PRESENCE OF BLACK SPOTS)		BLACK SPOTS SEEN ON APPENDAGES AND/OR BODY Score 0		MINOR BLACK SPOTS (MAY BE FINE/SCATTERY) Score 1
10a	SWIMMING BEHAVIOUR (BETWEEN STAGE VIII TO X)		SLEIGHISH MOTION Score 0		MODERATE MOVEMENT Score 1
					FAST, JUMP LIKE MOTION Score 2

© Tayamen, M., and Brown J.H. (1998). This table can be photocopied on condition that this copyright notice is retained  
 \*DA BFAR National Freshwater Fisheries Technology Research Centre, Philippines, \*Institute of Aquaculture, Stirling, UK

\* [CRITERIA Nos. 9 AND 10b ARE NOT ILLUSTRATED IN THIS TABLE; SEE FIGURE 36b]

This form provides a convenient way of recording your observations on the quality of *Macrobrachium rosenbergii* larvae

**Condition index for evaluating larval quality of *Macrobrachium rosenbergii***

No.	CRITERIA TO CHECK	SCORE		M A R M P I O																
		0	1	1	2	3	4	5	6	7	8	9	10							
1.	GUT FULLNESS	gut empty	moderately full (30%-50%)																	
2.	GIT LIPID CONTENT (STATE OF HEPATOPANCREAS)	no lipid vacuoles	very small vacuoles (10%-10%)																	
3.	PIGMENTATION (STATE OF CHROMATOPHORES)	no colour/pigments (fully colourless chromatophores)	moderate chromatophores in one area																	
4.	BODY COLOURATION	gray/bluish on abdominal segment	moderate light orange on abdominal segment																	
5.	SETATION	disfigured/damaged setae on rostrum, pereopods, telson, uropods	well-developed setae on rostrum, pereopods, telson, uropods																	
6.	MUSCLE TO GUT RATIO	Gut appears wide, muscle narrower on VI abdominal segment	Gut appears narrow and slightly wider muscle																	
7.	MUSCLE APPEARANCE OF ABDOMEN (APPEARANCE OF ABNORMAL MUSCLES)	opaque/gainy	slightly transparent																	
8.	MELANIZATION (PRESENCE OF BLACK SPOTS)	appendages and parts of body affected	very minor necrosis																	
9.	FOULING ORGANISMS	major parts of body affected	Minor parts of body affected																	
10.a	SWIMMING BEHAVIOUR (BETWEEN STAGE VII TO X)	sluggish/normal motion, utricular movement	moderate movement with head up/down																	
10.b	PHOTO POSITIVE RESPONSE (BETWEEN STAGE I TO VI)	negative response	slow positive response																	
				<b>Total score</b>																
				<b>Larval stage</b>																

Score ratings 0=poor 1=fair 2=excellent

Number of days \_\_\_\_\_ Batch/Tank No. \_\_\_\_\_

Date: \_\_\_\_\_ Scored by: \_\_\_\_\_

© Tayamen, M., and Brown J.H. (1998). This table can be photocopied on condition that this copyright notice is retained  
 DA-BFAR-National Freshwater Fisheries Technology Research Centre, Philippines, Institute of Aquaculture, Stirling, UK.

SOURCE: TAYAMEN AND BROWN (1999), REPRODUCED WITH PERMISSION FROM BLACKWELL SCIENCE

occurred). You are therefore recommended to terminate each larval batch after day 35, at the latest. This releases your equipment so that you can prepare for the next larval batch. Some hatchery operators transfer the remaining larvae from the original batch to another smaller tank to wait for them to metamorphose but this is not recommended.

## THE GREENWATER SYSTEM OF FRESHWATER PRAWN CULTURE

Many modifications of the 'clearwater' system exist. As stated earlier, no two hatcheries are alike. Some operators claim higher productivity for sophisticated alternative clearwater systems but they are more difficult to operate and they are therefore not detailed in this manual. The sections of the manual provided above have a general application to all clearwater freshwater prawn hatcheries, whether 'flow-through' or 'recirculation'.

A more common alternative to the 'clearwater' system for flow-through hatcheries is known as the 'greenwater' system. In the original type of greenwater system, which was developed in Hawaii, a mixed phytoplankton culture in which *Chlorella* spp. was dominant was maintained in separate tanks. Its cell density was about 750 000-1 500 000 cells/ml. A fertilizer solution in tap water was added to the tanks at least once per week to maintain the culture. This solution provided a mixture of 4 parts of urea to 1 part of NPK (15:15:15) garden fertilizer, applied at the rate of 185 g per 10 m<sup>3</sup> tank. Tilapia (*Sarotherodon mossambicus*) were held in the tanks at the rate of about 1 per 400 L to graze on and control filamentous algae. Copper sulphate, at the rate of 0.6 ppm was added to the greenwater tanks once per week to control rotifers. The tilapia also helped to fertilize the culture. The sodium salt of EDTA (ethylene diaminetetraacetic acid) was also sometimes included in the greenwater culture at 10 ppm as a chelator. The greenwater was prepared at the same salinity as the larval rearing water (Note: greenwater does not thrive at more than 12 ppt salinity) and was used as replacement water during exchange procedures instead of plain brackishwater. The greenwater culture was never used for larvae if the culture was more than three days old. Part had to be discarded or used for filling larval tanks and the rest diluted regularly to avoid phytoplankton 'crashes' (with the ensuing problems with low dissolved oxygen) occurring in the larval tanks.

Various local variations on the original greenwater system have been used since the Hawaiian system was created, particularly in Malaysia and Mauritius. Elsewhere, however, this technique has had limited success. Although the greenwater system may have some advantages (for example, it is claimed to act as a buffer against ammonia build up) it is difficult to manage successfully and adds more complications to the hatchery process. For this reason, most commercial freshwater prawn hatcheries now use clearwater systems of management, whether they are flow-through or recirculation. The greenwater system is not recommended in this manual.

## 4.3 Harvesting postlarvae

---

New postlarvae (PL) are about 7-8 mm long. Although PL can withstand the physiological shock of sudden transfer from 12 ppt water into freshwater, it is not recommended to harvest them from the larval tanks and transfer them directly into holding tanks containing freshwater. The animals are best acclimatized to freshwater in the larval tank. Once the majority of larvae have metamorphosed (at least by day 32-35), reduce the water level in flow-through system tanks to about 35 cm by using the turn-down drain. Then gradually flush the tank with freshwater over a period of 12 hours. Always continue to provide aeration during this process. The PL can then be harvested and transferred, or the larval tanks refilled to 70 cm with freshwater and the animals temporarily held in them. If the latter is

done, the PL should only remain in the larval tanks for a few more days, with frequent water exchange, before transfer to a larger holding tank. If you do not transfer them quickly enough, the biomass will become too high, and water quality deterioration and cannibalism will occur.

The best way to harvest PL from the larval tanks is to reduce the water level and then remove them in dip nets. Some hatchery operators use larval concentration systems which are similar to the larval siphon filtering device shown in Figure 35. However, this causes more stress than dip-netting and is therefore not recommended. During the harvesting process, cover most of the tank and allow the PL to concentrate in the illuminated area. The last few remaining PL can be obtained by removing the tank filter sock and flushing them to the exterior by lowering the turn-down drain and catching them in a net. Take care that animals do not become stranded, or dissolved oxygen levels fall too low, during these procedures. Estimate the number of PL for stock record purposes for every cycle (Annex 6). Quickly transfer your PL in any suitable container to holding tanks that contain pre-aerated freshwater. These temporary transport containers (e.g. buckets) should not be overcrowded with PL. Postlarvae should not be left too long in them or oxygen depletion will occur. However, no aeration or special packing is necessary unless the holding tanks are on another site.

Most flow-through hatchery operators harvest their postlarvae only once, at the end of the production cycle. Others, especially in research and recirculation hatcheries, prefer to make several harvests of PL before each cycle is terminated. If intermediate harvesting is practised, the first is made when about 25-30% of the larvae have metamorphosed. This usually occurs around day 23-28 after stocking. Then, two or three subsequent harvests are made at three-day intervals until the final harvest. The method is described by Valenti and Daniels (2000) but is not recorded here because a single, complete harvest is recommended for commercial freshwater prawn hatcheries in this manual.





# Postlarval holding and nursery phases

## 5.1 Basic requirements and facilities

The selection of sites for indoor nurseries should follow the same pattern as for hatcheries. Site selection for outdoor nursery facilities should be similar to that for grow-out ponds.

### HOLDING TANKS

After rearing your freshwater prawns in your hatchery, you need to be able to hold them until you stock them in your ponds or sell them to other people. 50 m<sup>3</sup> concrete tanks are convenient for holding postlarvae (PL) prior to transport for stocking in ponds. However, you can also use other sizes and types of tanks, similar to hatchery tanks. There are no special requirements, except that they must have supplies for freshwater and air. You can use branches and nets suspended from floats in the tanks (both referred to as 'substrates' in this manual) to increase the surface area available to the PL but this may make the normal operations of feeding, cleaning etc. (similar to hatchery operation) more difficult. Figure 37 shows PL utilising a nylon screen inside a holding tank.

### INDOOR (PRIMARY) NURSERY FACILITIES

Tanks for indoor freshwater prawn nurseries (Figure 38) can be constructed from concrete or fibreglass. The use of asbestos cement tanks is not recommended. The shape of nursery tanks is not important and their size, usually from 10 to 50 m<sup>2</sup> with a water depth of 1 m, depends on the area of the outdoor ponds which you (or those you sell juveniles to) are eventually going to stock with your product. You can use artificial substrates of various designs and materials to increase surface area; these provide shelter and increase survival rates.

Prawns tend to use the edges of substrates, whether they be natural (e.g. leaves, branches) or artificial. Layers of mesh can therefore be used to increase the amount of surface edges available to the prawns in both vertical and horizontal planes (Figure 39). Plastic

**Figure 37**  
Postlarval  
freshwater  
prawns can use a  
nylon screen as an  
additional  
surface area in  
holding tanks  
(Brazil)



SOURCE: EUDES CORREIA

netting can be placed in several layers over wood, aluminium, or PVC pipe frames. Suspend these 10 cm above the bottom of the tank, so that it can be cleaned. Hanging the mesh vertically allows the prawns easy access to the tank bottom to search for feed and allows detritus to fall to the tank bottom, where it can be siphoned out. Other substrate designs are feasible but you must be careful to think about the effect of the substrates that you use on your ability to manage the tanks (feeding, observation, cleaning, etc.).

The water supplies for indoor nurseries can be flow-through or recirculating. For flow-through, allow the water to continuously enter from above the tank water level and exit from the lowest part of the tank through a vertical standpipe with an outside sleeve (pipe with a larger diameter) extending higher than the water surface. Cover the standpipes with a 1.0 mm mesh screen to prevent PL and juveniles from escaping. This drainage system draws water from the tank bottom where food waste and detritus settle.

If you wish to operate your primary nursery tanks on a recirculation system it can be similar to those used in recirculation hatcheries.

## OUTDOOR (SECONDARY) NURSERY FACILITIES

Nursery ponds are similar to grow-out ponds in design and facility requirements; these are described later in this manual. They usually vary in area from 300 to 2 000 m<sup>2</sup>. Some operators cover their nursery ponds with plastic netting to avoid predators, especially dragonflies, whose nymphs predate on freshwater prawn PL. Do not fill the ponds earlier than 2 days before PL are stocked; this will prevent such predators becoming established before the prawns arrive. You can use artificial substrates to increase the surface area available to the prawns, as described in the manual section on grow-out in temperate areas. Make sure

**Figure 38**  
Overhead air and  
water distribution  
systems are used  
to supply these  
indoor nursery  
tanks (USA)



SOURCE: CHARLES WEIBEL

**Figure 39**  
Substrates can be used in nursery tanks to increase the surface area available to juvenile prawns; this substrate consists of the material used to make barriers around roadworks (USA)

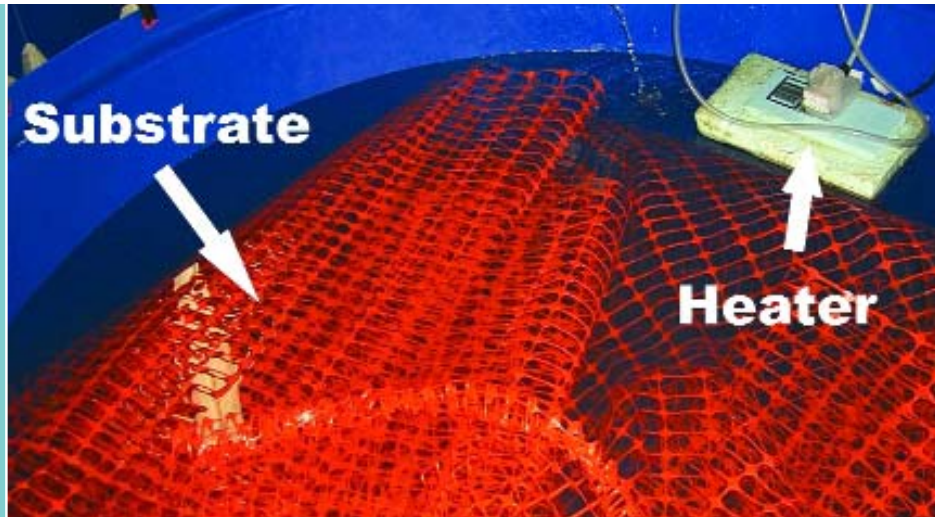

**SOURCE:** CHARLES WEIBEL

that ponds are treated between cycles, as described in the section on grow-out. Figure 40 shows an internal turn-down drain in use during pond draining and sediment removal.

### NURSERY CAGES

Postlarvae can also be nursed in cages but research on the best ways to manage cages for this purpose is not yet complete enough to recommend this in this manual. The scientific literature describes (for example) the use of 1 m<sup>2</sup> cylindrical cages constructed from 0.64 cm mesh galvanized hardware placed in the mud bottom of a pond (although these were described as cages, they are really pens). In this case, animals weighing almost 2 g were stocked. PL or juveniles would require a much smaller mesh size. 2 x 1 x 1 m cages made of iron with a 1.0 mm nylon mesh, suspended above the pond bottom (real cages) have also been described for stocking PL. Such fine mesh would need careful cleaning to ensure proper water exchange and the mesh size would need to be increased as the animals grow.

## 5.2 Holding postlarvae before sale

You should not retain PL in your holding tanks for more than a week or two prior to stocking in nursery facilities, grow-out ponds, or sale. The length of time you hold them depends on the demand for PL. If you have to retain the PL longer, you must reduce the density of animals. You can then sell the prawns as juveniles, which have a higher value than PL, reflecting the increased costs of holding them longer. Whilst the PL are in the holding tanks you must continue to exchange the rearing water (40-50% every 2-3 days) and provide aeration. You can maintain PL at

**Figure 40**  
The standpipe drain in this pond, normally vertical, is turned down to allow water to flow out (USA)



**SOURCE:** CHARLES WEIBEL

densities of up to 5 000 PL/m<sup>2</sup> for one week (Note: once animals become PL, it is normal to refer to density on an area rather than a volume basis, that is per m<sup>2</sup>, not per m<sup>3</sup>), or up to 1 500-2 000 PL/m<sup>2</sup> for one month under these conditions. If you need to hold them for one month, you could improve survival if you reduce the density to 1 000/m<sup>2</sup>. Using substrates can help you maximize the stocking density, thus reducing other equipment and labour costs.

You do not need to continue feeding BSN after metamorphosis. You can immediately use the same diets as are used for pond feeding. However, some hatcheries prefer to use a floating diet in the holding tanks. This makes it easier to visually judge the quantity to feed. The young PL, although they tend more and more to cling to and crawl on surfaces, still swim quite actively in the water and utilize a floating diet well. A floating catfish diet or even an expanded pet food is adequate. Some hatcheries continue to use egg custard based diets for a few days.

Many grow-out farmers prefer to stock production ponds with juveniles instead of PL. If they do not want to have nursery ponds themselves, you will need to provide this facility on your own site. The management of nursery facilities is dealt with later in this section of the manual.

### 5.3 Transporting postlarvae

---

Cooled and aerated fish transport tanks are ideal for transporting freshwater prawn post-larvae (PL) from the hatchery holding tanks to the pond site but they are rarely available or affordable. For journey times of up to one or two hours to the pond site, you can use aerated garbage cans. A 100 L trash can, holding 50 L of water, will hold 50 000 PL. You should insert baffles in the container to prevent excessive water movement during transport. Larger, open plastic tanks (1 m<sup>3</sup>), containing about 500 L of aerated water, can hold about 500 000 PL during a short journey.

For longer distances you can use the method employed for transporting aquarium fish. Place them in double plastic bags containing 1/3 water and 2/3 air or oxygen (Figure 41). You can put about 250-400 PL in each litre of water. A 45 x 80 cm bag holding 8 L of water, for example, will take 2 000-3 000 PL. Higher or lower transport densities are used by some hatcheries. It is suggested that, if you have not done this before, you carry out some simple experiments to determine the optimum density for your conditions (length and duration of journey, climatic conditions, etc.). Round off the corners of the bags with rubber bands to prevent animals getting trapped there. Twist the top of the bag and bend it over, sealing it tightly with a rubber band after you have inflated it with air or oxygen.

These inflated bags can be used to transport PL very long distances (up to at least 16 hours travelling time by road). If you put them into insulated 'styrofoam' boxes you can ship PL by air most effectively. If they are in non-insulated boxes you can send them on night (cool) journeys by rail, for example. For long day-time (hot) journeys, you can stack the plastic bags on shelves in a home-made transport box mounted on a truck. The transport truck (Figure 41) should be insulated. Place garbage cans filled with ice on the floor, to keep the temperature down.

Lowering temperature during transport reduces metabolic activity and improves survival. You should also use water from the holding tank to fill the plastic transport bags. If you place the PL into 'new' water for transport, many will moult during the journey and many will be lost through cannibalism. Some hatcheries add a very small amount of seawater to the transport bags, claiming that survival rates are better in brackishwater than in freshwater. You can try this for yourself but remember that increasing salinity will lower

# FIGURE 41

Postlarvae in plastic bags can be transported long distances in modified trucks provided with shelves, a small fan, and simple cooling

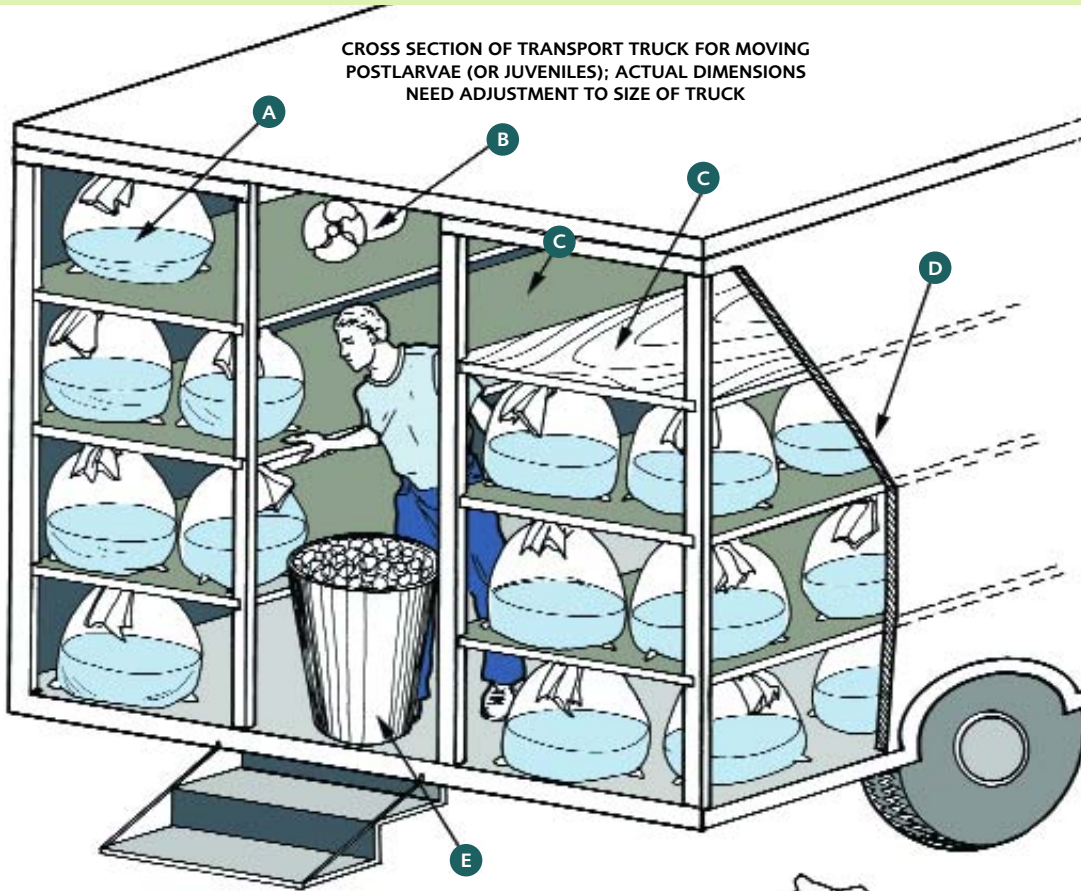

CROSS SECTION OF TRANSPORT TRUCK FOR MOVING POSTLARVAE (OR JUVENILES); ACTUAL DIMENSIONS NEED ADJUSTMENT TO SIZE OF TRUCK

- A** transport bag containing postlarvae
- B** fan mounted on truck ceiling
- C** shelves for transport bags
- D** 2 inch layer of styrofoam between two sheets of marine plywood provides good insulation
- E** garbage can filled with ice, which can be replenished during long journeys
- F** twist the top of the bag, turn it over and fasten tightly with an elastic band
- G** bag inflated with compressed air or oxygen; this should occupy two-thirds of the bag volume
- H** plastic bag
- I** water containing postlarvae; this should occupy one-third of bag volume
- J** round off the corners with elastic bands to prevent postlarvae getting trapped there

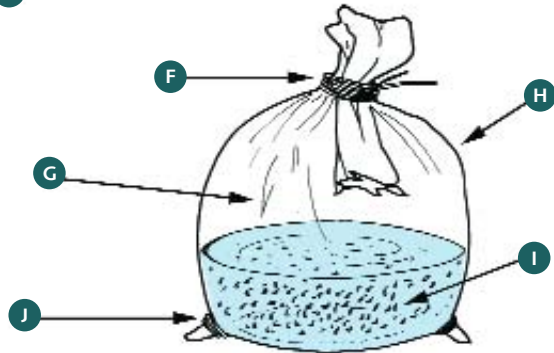

SOURCE: EMANUELA D'ANTONI

the dissolved oxygen content of the water and, if extreme, may make it necessary to adjust the salinity again before stocking the animals in the rearing water. A transport temperature of about 20-25°C is recommended for journeys of less than 6 hours. Keep it down to 20-22°C for longer trips. A one ton truck can transport up to 500 000 PL in plastic bags. You can keep the temperature steady throughout the truck by using electric fans driven from the truck engine or batteries. You can get very good transport survival in this way.

To facilitate stocking at the pond site it is normal to standardize the number of prawns in each transport bag. It is therefore necessary for you to estimate the quantity of PL as accurately as possible when the bags are filled (Annex 6). It is not necessary to be exactly accurate. The value of accuracy must be set against the losses of PL which would be caused by excessive handling. However, you must make reasonably accurate estimates because it is upon this figure that pond stocking and feeding rates will be based and charges for PL levied.

The survival rate of 7 day old (after metamorphosis) PL during shipping is much higher than 1 day old animals. It is not good practice to ship PL of widely different age groups. However, because of the method of larval culture, the age (post-metamorphosis) of the PL will inevitably vary by a day or two.

## 5.4 Managing nurseries

---

Many grow-out farmers stock *M. rosenbergii* postlarvae (PL) obtained from hatcheries directly into their ponds; the age of these PL varies because they will have been in holding tanks for different periods of time. Other farmers prefer to stock larger juveniles that have been reared from PL in their own nursery facilities or bought from commercial hatchery-nurseries. Since nurseries can be stocked at higher densities than grow-out enclosures, there are potential savings in space, labour, feed and cost. In addition, the early mortalities will have already occurred before grow-out facilities are stocked, and strong juveniles are therefore being selected. Poor survival rate in a particular batch is easier to notice in a crowded nursery pond than it is in a production pond. It is much cheaper to replace a poor batch of PL at this stage than not to realize the problem until grow-out harvest time. On the other hand, some prefer to avoid too many nursery stages, in order to minimize the losses that occur through frequent animal transfer and handling, and that occur through the greater risk of disease problems in high-density culture.

Postlarvae (here defined as young juveniles of 7-10 mm in length and 6-9 mg in weight) can be cultured at high densities from metamorphosis to juveniles in nursery systems. Nursery facilities include primary (indoor) nurseries, secondary (outdoor) nurseries in ponds, and cages. Indoor nurseries are used primarily in temperate regions, where outdoor culture is only possible during a limited season (say 6-8 months); this extends the total time available for prawn growth. Nursery management may be single-phase, two-phase, or multi-phase operations. One- and two-phase operations may combine outdoor and indoor systems. A full description of these systems is contained in Alston and Sampaio (2000).

### INDOOR (PRIMARY) NURSERIES

#### General management

Tanks for holding postlarvae (PL) are a form of indoor nursery. However, their purpose is not really to grow the PL to a larger size before stocking but simply to be able to maintain them before sale. Sometimes hatcheries use holding tanks to acclimatize their PL to the

pH and temperature of the rearing facilities where they are to be stocked. True indoor nurseries contain tanks where PL are intentionally reared to a larger size before transfer to outdoor nurseries or grow-out ponds.

Nursery tanks require aeration and may be operated as flow-through or recirculating systems, like hatcheries. Siphon the tank bottoms regularly to remove food wastes, faeces, and decomposing organic matter. Some nurseries allow organic matter to accumulate to enable PL to graze on 'lab-lab' but this may be difficult to manage without getting into water quality problems. Between cycles, you should dry out the tanks, disinfect them (the same way as hatchery tanks), and leave them to dry out for at least 48 h to minimize problems with pathogens. Do not forget to flush them out well to remove all traces of chlorine.

### Keeping the water quality good

General water quality requirements for indoor nurseries are similar to those for freshwater in hatcheries. Maintain the optimum temperature (27-31°C) by heating the water in the system or the building in which they are housed, if necessary. If you are operating a recirculation nursery system, a turnover rate through the biological filter of 12 times a day is suggested.

### Stocking rates

The best stocking density for indoor nursery tanks depends on the length of time the animals will remain in the tanks before transfer to an outdoor nursery or grow-out facility. You are recommended not to exceed a stocking density of 1 000 PL/m<sup>3</sup> in tanks without substrates. You can stock 2 000 PL/m<sup>3</sup> in tanks where substrates are provided (Figure 42). These stocking densities assume that the indoor nursery rearing time is not more than 20 days. You would need to reduce the density if you are going to keep the prawns in your indoor nursery for longer periods (e.g. in sub-tropical and temperate regions, where prawns are usually maintained in indoor nurseries until the grow-out ponds reach temperatures of at least 20°C). Maintaining prawns in commercial indoor facilities for periods longer than one month may prove too expensive, although they are often maintained longer than that for research purposes.

### Feeding strategy

Feeding once or twice per day is sufficient. You should adjust the quantity of feed based on observing the actual consumption. It should normally be about 10-20% of the total weight

of the prawns in the tank. Grow-out feeds can be used but enhanced results may be obtained by supplementing them with other materials, such as beef liver, egg custard based diets (EC), or minced fresh

**Figure 42**  
The substrate material shown dry in Figure 39 can be seen beneath the water surface in this nursery tank (USA)

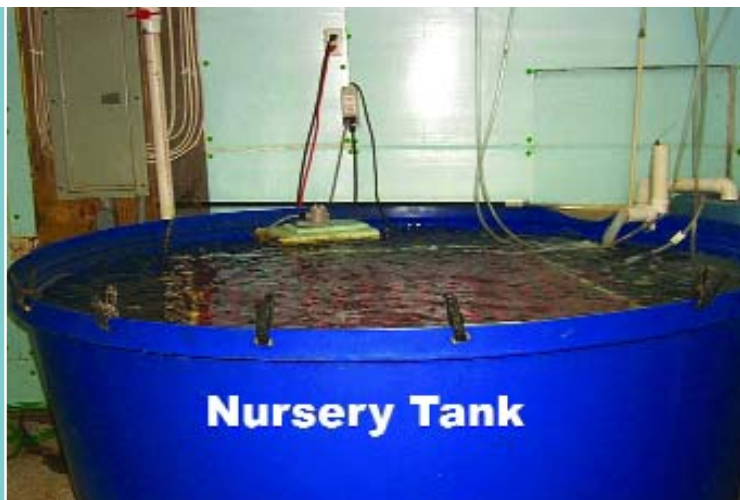

SOURCE: CHARLES WEIBEL

fish. However, you must take great care if you use fresh feeds. Fresh feeds, which usually break down more easily than pelleted diets, may rapidly cause water quality problems. This could overload recirculation systems or mean that you would need to have a much greater water exchange in flow-through systems (this is not such a problem as in hatchery systems, because nursery water is not brackish; however, it would increase pumping and other costs). Adult *Artemia* (*Artemia* biomass) have also been used as a nursery feed for *Macrobrachium rosenbergii* in countries where it is readily available as a fresh (live) product from salt farms. Recently (2000), a freeze-dried version of this product has also become commercially available.

### Growth and survival rates

When prawns are stocked as postlarvae, their weight will be about 0.01 g. After 20 days in nursery tanks, the juveniles should be about 0.02 g, and they should reach about 0.3-0.4 g after a total of 60 days at reduced densities. Cannibalism, competition and poor water quality are the main causes of mortality in indoor nurseries. However, survival rates of about 90% can be obtained up to 20 days.

### Harvesting juveniles

You can use dip nets (3 mm mesh) for catching juveniles from indoor nurseries. Estimates of the numbers of juveniles present must be made, using the technique given in Annex 6. Estimates of average weight should also be recorded. It is only by keeping records like this that you can compare the success (or failure!) of different batches and your management procedures. The method of transporting animals to ponds has been discussed earlier in this manual.

## OUTDOOR (SECONDARY) NURSERIES

Outdoor nurseries are similar to grow-out ponds and can be stocked with newly metamorphosed postlarvae (PL) from hatcheries, or with juveniles from primary nurseries. In the secondary nurseries you can rear them until they reach 0.8-2.0 g. This may take 4-10 weeks, depending on the source used for stocking.

### General management and water quality

Supplemental aeration is ideal but may be too expensive. If you use substrates you can improve performance. This is discussed in the section of this manual that deals with grow-out in temperate areas. Between rearing cycles, you should disinfect your nursery ponds by applying 1 mt/ha of burnt lime or 1.5 mt/ha of hydrated lime to kill unwanted pathogens. Water quality and its management in secondary nursery systems is similar to that employed for grow-out.

### Filling and stocking ponds

Postlarvae are especially sensitive to the effects of algal blooms (excessive quantities of algae; the methods for controlling these are described in the grow-out sections of this manual) and high pH. Some operators allow natural food to build up, and pH to stabilize, over a period of 10-14 days after pond filling, before stocking. However, this causes predators and competitors to become established, with consequential effects on prawn survival. It is not recommended in this manual. Stock your ponds immediately (within 2 days) after filling them with filtered water, which has no predators and causes no photosynthetically-induced pH changes. You may not get quite such high initial prawn growth rates from ponds with little natural food but increased survival will outweigh this factor.



It is difficult to recommend exact initial stocking rate in outdoor nurseries because this is site-specific (e.g. temperature profile over time; prawn size at stocking; the length of time the prawns will remain in the nursery ponds; the presence or absence of substrates and aeration; the amount of predation and whether the ponds are covered to reduce this, etc.). If your nursery ponds have no substrates or aeration, do not exceed stocking rates of either 1 000/m<sup>2</sup> of PL, 200/m<sup>2</sup> of small juveniles (0.02 g), or 75/m<sup>2</sup> of 0.3-0.4 g juveniles. You can increase these stocking densities if you provide substrates, aeration and predator protection.

### Feeding strategy

Normally, outdoor nurseries use grow-out feeds, which may be either bought from commercial sources or made on the farm. Feeding once or twice per day is sufficient. You can also add some supplementary fresh feeds but you must be careful about water quality problems, as mentioned earlier in this manual. The quantity of feed should be adjusted after observing the actual consumption but should be about 10-20% of the total weight of the prawns in the pond.

### Survival and growth rate

Some mortalities (10-20%) will occur soon after PL are stocked, even when the conditions are ideal. To determine the rate of survival, a sub-sample of the animals should be evaluated within a mesh bag (cage) suspended above the pond bottom. If the survival is poor after 24 to 48 h, stock more PL, unless poor water quality was the cause of the mortalities. Over-stocking is much easier to remedy later than under-stocking. Total survival from stocking (or re-stocking) until removal from the nursery ponds should be at least 75%. The weight of the prawns at the end of the outdoor nursery period should be about 0.8-2.0 g, but the time taken to reach those sizes will depend on local conditions.

### Harvesting, grading, and transport

You can harvest juvenile prawns by seining your ponds two or three times with a 5 to 6 mm mesh seine, or by emptying them completely. If you use drainage, the juveniles should be trapped in a large catch basin or box at the end of the outlet. The catch structure should not stress the prawns. Polypropylene boxes or tanks filled with water from the nursery pond and kept aerated, can be used to transport the juveniles to the grow-out ponds if they are close by. More care needs to be taken if you are taking them to sites further away (see the section on transport of PL). You should estimate the numbers of juveniles harvested (Annex 6) and transported to the grow-out ponds. There are some advantages in grading the juveniles into two or three groups, depending on their average weight, before stocking them into separate grow-out facilities. This decreases competition in grow-out ponds by reducing HIG (Annex 8) and increases productivity. Grading is discussed in the grow-out section of this manual.

## OTHER SYSTEMS

### Multi-phase nursery systems

A number of multi-phase nursery systems have been developed for research and commercial systems. The simplest system, developed in Israel, involved stocking ponds with newly metamorphosed PL at 1 000 to 10 000/m<sup>3</sup> in the first phase. 15 to 30 days later they were transferred into second phase ponds at 100 to 200/m<sup>2</sup> for a further 60 day period. Survival rates of 92% (phase 1) and 85% (phase 2) were achieved. Other multiphase systems have

been modelled or commercially applied but are not described here because they are complex and/or their true value has not been adequately demonstrated. Further details can be found in Alston and Sampaio (2000).

### Nursing in cages

Some research work on nursing postlarvae in cages has been carried out. These involved the rearing of newly metamorphosed PL (stocked at initial densities of 2-10 PL/L) in 2 x 1 x 1 m and 1 x 0.5 x 0.7 m cages for 20 days. The prawns grew to 50 mg at the lowest and 30 mg at the highest stocking densities. Survival rates were not significantly different up to a stocking density of 8 PL/L. Another experiment involved the stocking of 0.19 g juveniles at 50 and 100 prawns/m<sup>2</sup>; the prawns grew to 3.2 and 2.4 g in 2 months, with survival rates of 86% and 75%, respectively. A further experiment stocked with 0.05g juveniles at 100-800/m<sup>2</sup> and reared them for 60 days in similar cages; the prawns reached 0.35-0.79g.

Research on this topic is sparse and the results need to be confirmed on commercial farms. At the time this manual is being prepared, the operation of cage nurseries is therefore not yet recommended for commercial practice. This does not mean that the practice has no potential value, simply that no clear recommendations can be made at this time.



# Grow-out phase

**FRESHWATER PRAWNS** may be stocked into concrete and earthen reservoirs, ponds, irrigation ditches, cages, pens and natural waters. Cage and pen culture is experimental, while the production from irrigation ditches is low. Stocking natural waters and reservoirs is called fisheries enhancement. Freshwater prawns are obtained from rivers, or (less frequently) from nurseries, for stocking into open waters. Stocking PL is impractical because most would be lost through predation. Larger juveniles (2-3 g) are usually used for enhancement purposes. The topic of fisheries enhancement is only mentioned here but is described in more detail in New, Singholka and Kutty (2000). This section of the manual deals only with the management of freshwater prawns being reared in earthen ponds.

A freshwater prawn farm is very similar to a freshwater fish farm. A detailed farm design is not provided in this manual because every farm must be unique to its site characteristics. A photograph of a large freshwater prawn farm is given in Figure 43. This section of the manual briefly introduces some general principles of aquafarm development. In doing so, it draws upon some other FAO manuals on site surveying (FAO 1989b), the provision of water supplies (FAO 1981), and farm and pond construction (FAO 1992b, 1995). A simple manual on small-scale freshwater fish farming (FAO 1994) is also available. If you are going to build your own farm, it is highly recommended that you obtain these publications before you develop your farm.

## 6.1 Site requirements and construction

Site selection has been covered earlier in this manual. Having selected the site you will need to thoroughly survey it to determine the best layout for water intake, ponds, access roads, and effluent discharge. These topics are not specific to freshwater prawn farms, so there is no attempt here to duplicate the FAO manuals already available, which have been mentioned above. The development of sites for freshwater prawn farming is discussed in detail in Muir and Lombardi (2000).

**Figure 43**  
*Macrobrachium rosenbergii* farms can be large (this one was 70 ha) but need careful production, marketing and business management for sustained success (Brazil)



SOURCE: MICHAEL NEW

## DEFINING THE POND

### Choosing its area and shape

If you are going to use seining for harvesting, which is often practised in freshwater prawn farming because of the necessity to cull out larger animals (and sometimes to separate females from males, when they have different values) before the final harvest, rectangular ponds are the most suitable shape. The maximum width for this type of management should not be wider than the space through which a seine can be conveniently drawn from one end of the pond to the other by manual labour. A convenient width is 30 m. In practice, of course, wider ponds can also be seined but not so efficiently as narrow ones. The length of the pond depends partly on the topography of the site and partly on the pond size and farm layout chosen. It is best to standardize the width of ponds; otherwise a range of different seine nets will be required for harvesting.

The most easily managed pond sizes range between 0.2 ha and 1.6 ha, with most farms having ponds around 0.2-0.6 ha. If kept to a 30 m width, a 0.6 ha pond will be 200 m long. Narrow ponds should be oriented so that the prevailing wind (which enhances the dissolved oxygen content of the water) blows down the long axis towards the drain end, to lessen the area of the pond bank subject to wave erosion.

Large ponds are normally wider than 30 m and often drained for harvesting. If the total harvest is going to be taken at one time (batch management), the size of the pond should be influenced by the maximum weight of prawns that the market will accept at one time without price deflation. For example, if a quantity greater than 300 kg of freshwater prawns would swamp your market and reduce prices it would be pointless to have a drainable pond greater than 0.15 ha in area (assuming a productivity of 2 mt/ha/crop).

Information on pond construction is introduced in Muir and Lombardi (2000); details of construction techniques are provided in FAO (1995).

### Choosing its depth

The average depth of water in freshwater prawn ponds in tropical areas should be about 0.9 m, with a minimum of 0.75 m and a maximum of 1.2 m. Deeper ponds (an average of 1.2-1.4 m) are used in colder areas to maintain more stable water temperatures. However, deeper ponds are difficult to manage. Even if you have ponds of the recommended average depth you may have to drain or pump out part of the water to facilitate seining operations at the deep end. In the cool season, the temperature of the water at the bottom of deep

ponds may become low enough to reduce feed consumption by the prawns. On the other hand, the water in shallower ponds may become too hot for the prawns in the hot season and the water may be quite clear, exposing the prawns to greater predation. Shallow ponds also tend to support the growth of rooted aquatic plants and are not recommended.

The bottom of the pond must be smooth (Figure 44). There must be no projecting rocks or tree stumps in it; these would prevent efficient seining and damage nets. The pond bottom must slope gradually and smoothly from the water intake end towards the drain end so that, when drained, pockets of undrainable water in which prawns become stranded and die do not occur. A slope of 1:500 (0.2%) is suggested for ponds 0.4 ha or more in area and 1:200 (0.5%) for smaller ponds towards the outlet, where drain harvesting occurs. This is equivalent to 2-5 cm per 10 m length. Thus (for example), in a pond which is 100 m long with an average water depth of 0.9 m (90 cm) and a slope of 0.5%, the water would be 65 cm deep at the intake end and 115 cm deep at the outlet end.

FIGURE 44

The bottoms of grow-out and nursery ponds need to be sloped towards the drainage point and to be smooth; this increases the efficiency of both drain-harvesting and seine-harvesting

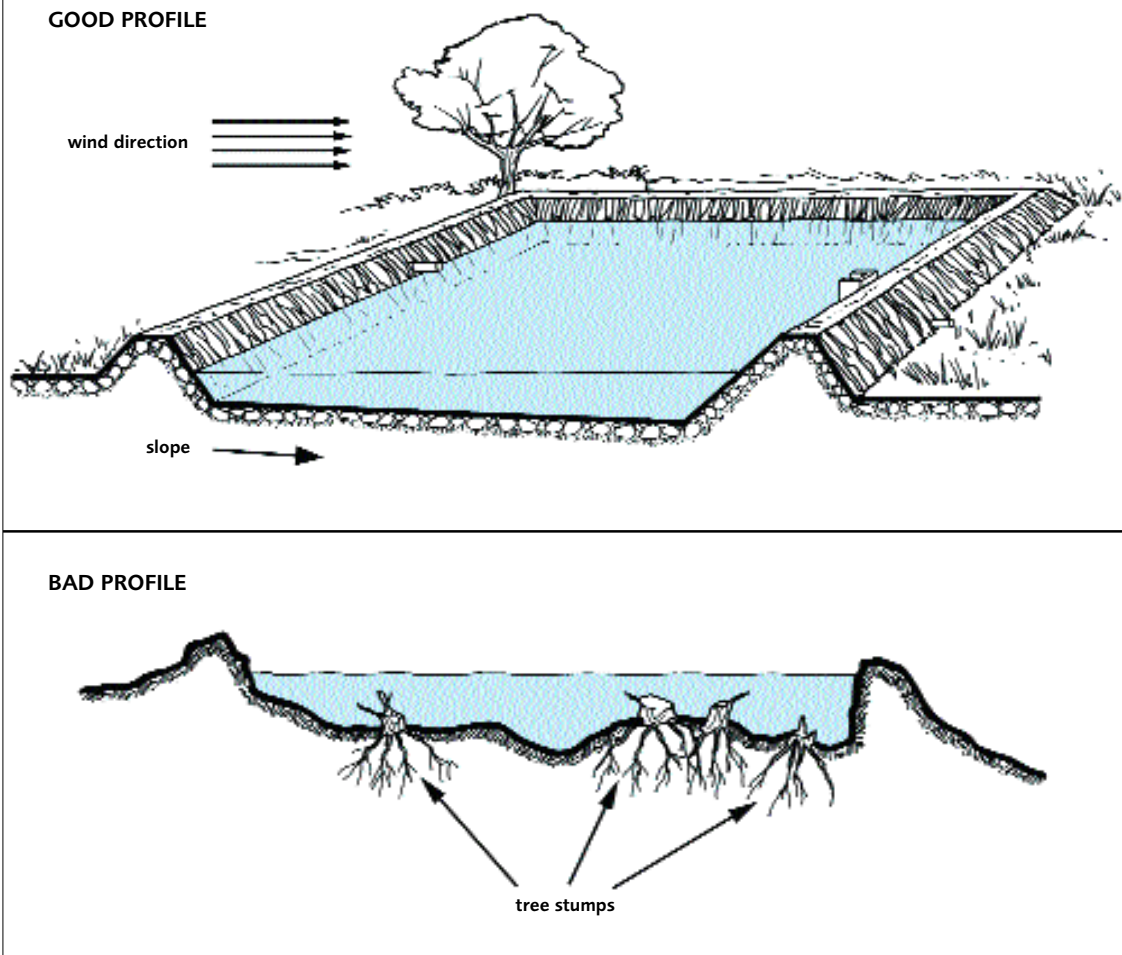

SOURCE: EMANUELA D'ANTONI

## Constructing the pond banks

The banks of the ponds (sometimes referred to as embankments or bunds) must be high enough to provide a freeboard of 30-60 cm above the highest water level expected in the pond. Thus, in a pond with a water depth of 65 cm at the shallow end and 115 cm at the deep end, the total bank height must be a minimum of 0.95 m (inlet end) to 1.45 m (outlet) high. The pond banks must also be high enough to protect the pond from exterior flooding. Proper compaction must be employed, both in the construction of the pond banks and the treatment of the bottom of the ponds to maximize water retention. Where the retention characteristics of the soil on the site are not good, a core of impervious material brought from outside the site must be provided during pond bank construction. This core should extend below the level of the bottom of the pond (Figure 45).

For ease of management the internal slope of the pond bank should be 3:1 but it may need to be as high as 4:1 in sandy areas to minimize erosion (and the consequential need for repairs). In highly stable soils the inner slope should not be less than 2.5:1 (Figure 46). Very small ponds with almost vertical sides may be constructed for artisanal purposes in floodplains having very sticky and impermeable clay soils. Fruit trees or other crops may be planted on the pond banks. Sometimes attempts are made to protect the banks from excessive erosion by stakes (for example). Having vertical or near-vertical pond banks almost certainly leads to rapid erosion problems; Figure 47 illustrates the result. This

### FIGURE 45

When you construct ponds in areas where the soil structure is less suitable, the banks will leak less if you bring clay from another site and use it to make an inner impervious core

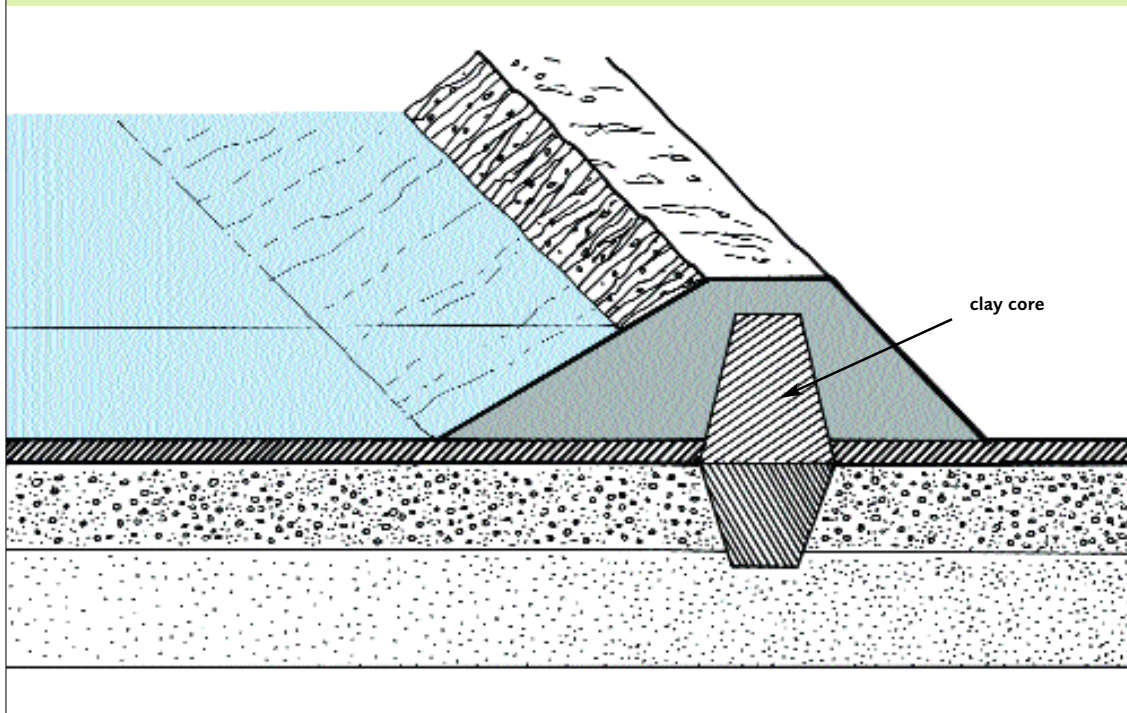

SOURCE: EMANUELA D'ANTONI

# FIGURE 46

Pond banks should have the proper angle of slope if you want to minimize erosion and cut down the costs of maintenance

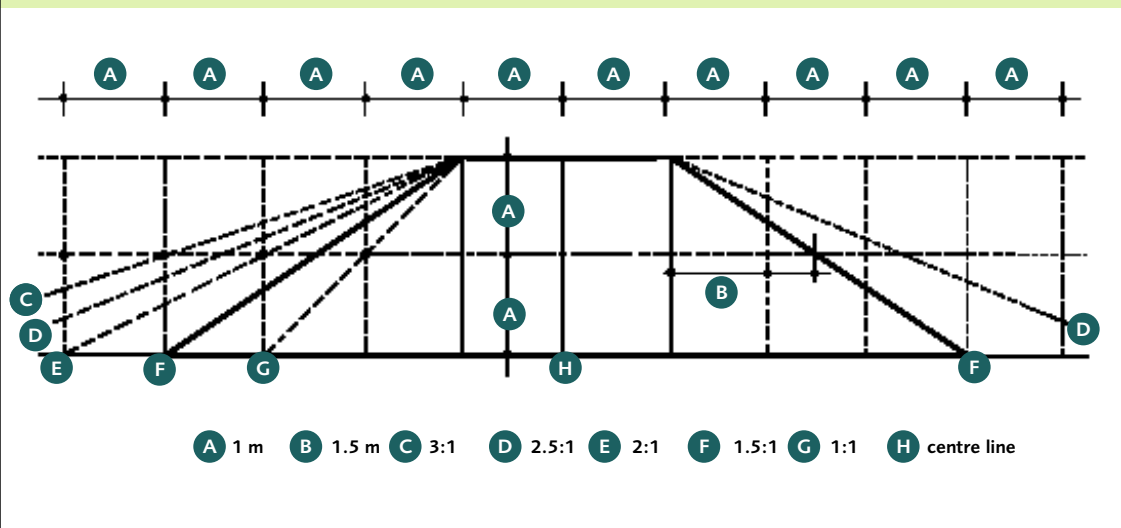

SOURCE: EMANUELA D'ANTONI

means that a lot of maintenance will be required and they are certainly not recommended for larger commercial-scale farms.

The external pond bank slope should preferably be at least 2.5:1 and never less than 1.5:1, even for highly stable soils. Properly constructed pond banks are more expensive and use more land but failure to build them correctly may result in severe erosion (Figure 47). After construction, you should plant the banks with fast growing grass (e.g. *Phyla nodifera*), kudzu (a woody vine) or taro (dasheen), to help prevent erosion. Figure 48 illustrates pond banks overlaid with turf. Figure 49 shows banks planted with grass, banana and coconut trees. The planting of large trees or plants with extensive root systems on top of the pond banks may break up the pond bank and cause leakage, so caution is recommended. Plants such as banana, palm trees and papaya are acceptable and palms form wind breaks.

**Figure 47**  
The bank of this freshwater prawn pond is being eroded because its slope is too steep (Hawaii)



SOURCE: SPENCER MALECHA

**Figure 48**  
The banks of these ponds have had grass turfs laid on them (Brazil)



SOURCE: WAGNER VALENTI

**Figure 49**  
Pond bank  
planted with  
coconut, grass, and  
banana; besides  
stabilising the bank  
this is a form of  
integrated farming  
(Thailand)



**SOURCE:** HASSANAI KONGKEO

The tops of the pond banks between ponds should be a minimum of 1 m wide to allow workers to walk round the ponds carrying feed and harvesting gear. Narrow pond banks with almost sheer sides are sometimes staked to prevent collapse but they need constant maintenance particularly if the site is sloping and the water level in adjacent ponds is different. Make sure that you have a pond bank width of at least 2-3 m at one side of the pond (usually the drain end or where harvest nets are to be beached) so that trucks can be brought to the pond side for delivering PL and feed and picking up harvested prawns, especially live prawns. On larger farms, particularly where mechanical broadcasting of feed is employed, you must provide a wide pond bank top (usually 3.5-4.0 m) on one of the long sides of the pond as well as at one end.

Information on pond bank construction is introduced in Muir and Lombardi (2000) and construction details are provided in FAO (1995).

## SUPPLYING WATER TO THE PONDS

The characteristics of the water supply required for freshwater prawn farming have been discussed earlier in this manual. The topic of water supply is introduced in Muir and Lombardi (2000) and detailed in FAO (1981).

It is not normal to treat the water entering freshwater prawn ponds except to screen it to prevent entry of predators. Screening is not necessary where the water supply is piped from a well or a spring but is essential where surface water or open channel distribution is used. Well water requires aeration by cascading (Figure 50) or by supplying it above pond water level to re-establish gas equilibrium, as it is often initially very low in dissolved oxygen content. There are many alternative methods of screening. Crude screening excludes adults and fingerlings of unwanted species but not their eggs or larvae. Figure 51 shows a simple gravel filter which will exclude fish eggs and larvae as well. Water filtering devices are discussed in other FAO manuals (e.g. FAO 1992b, 1996).

The way in which water is distributed and supplied into freshwater prawn ponds is of great importance. Farms must be designed with a water distribution system that will allow the filling of one pond (or 10% of the pond surface area, whichever is the greater) at any time without starving the other ponds of replacement and flow-through water (Table 6).

There should not be any contact between incoming water and water drained from other ponds. Each pond should have its own individual supply from a central water distribution channel and should not receive the outflow from another pond (Figure 52). The trans-



# FIGURE 50

The dissolved oxygen levels of incoming pond water can be increased by rippling and cascading

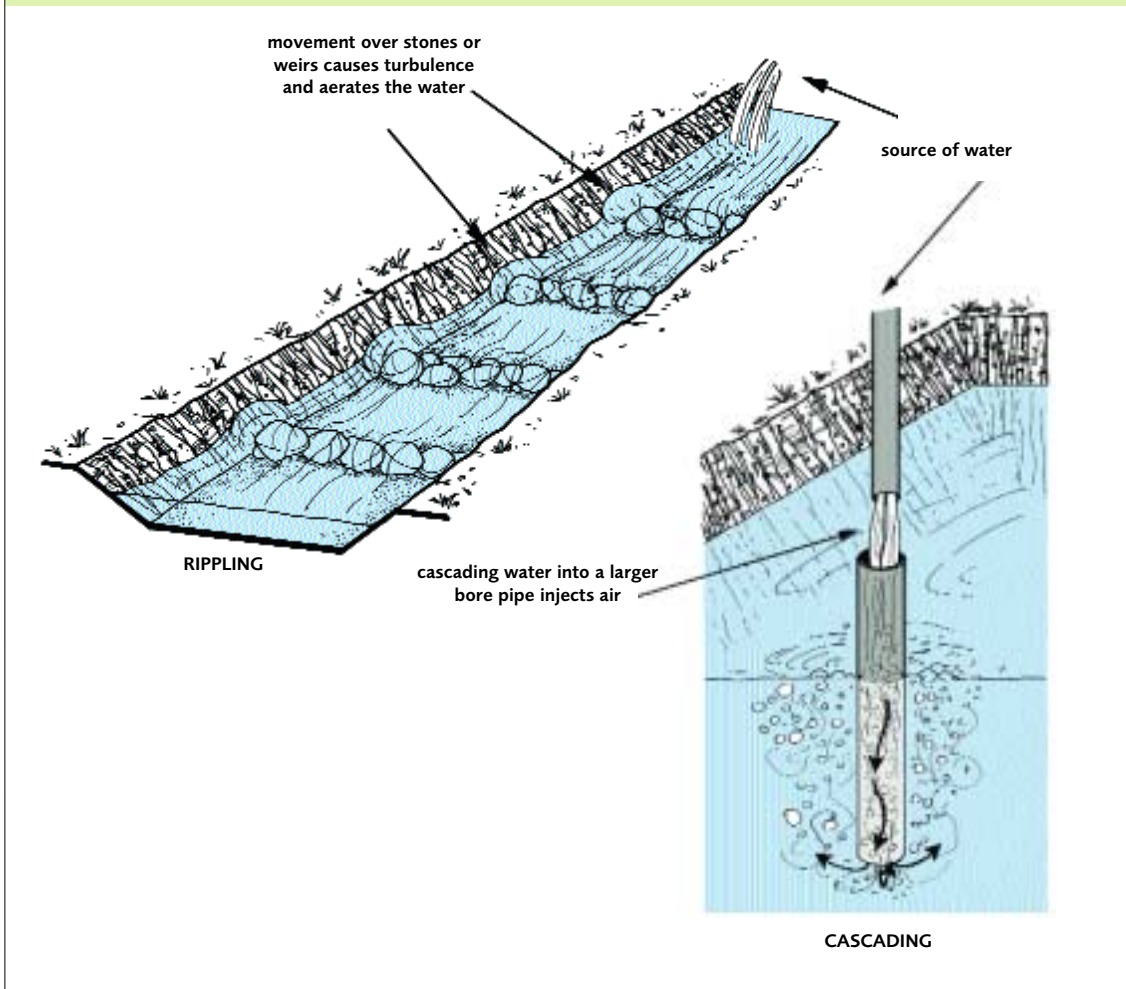

SOURCE: EMANUELA D'ANTONI

Figure 51  
Simple gravel filters on the water intake system help to minimize the predators in freshwater prawn ponds (Peru)



SOURCE: OSCAR ORBEGOSO MONTALVA

Design your water distribution system so that each pond has a separate supply and the discharge from each pond does not enter any other

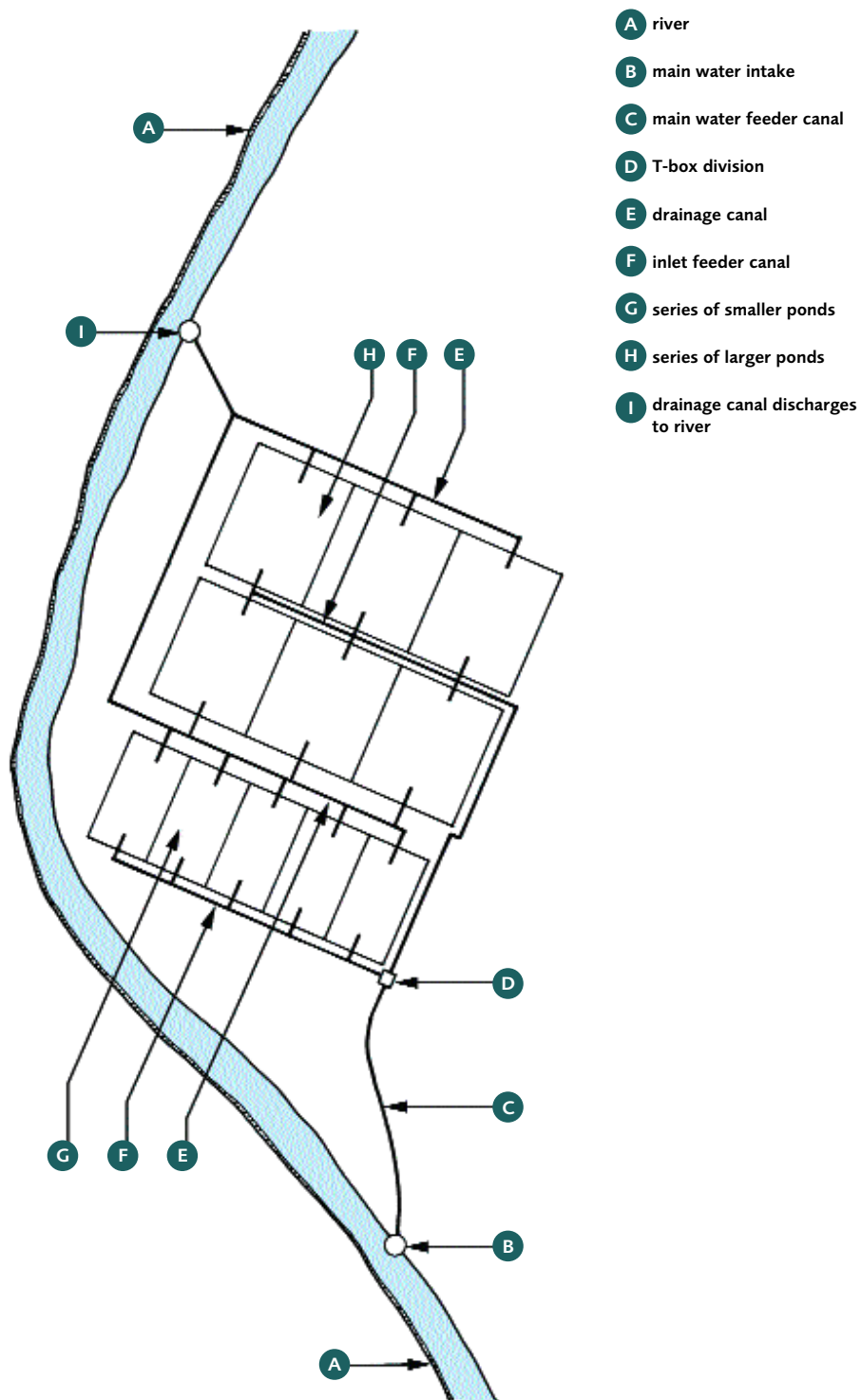

SOURCE: EMANUELA D'ANTONI, AFTER FAO (1992b)

**Figure 53**  
Where the topography of the site makes it feasible, supplying water by gravity keeps the dissolved oxygen level high (Brazil)



**Figure 54**  
Supplying water above the pond water level provides some oxygenation, while grass minimizes erosion of the bank (Brazil)



**SOURCE:** JULIO VICENTE LOMBARDI, REPRODUCED FROM NEW AND VALENTI (2000) WITH PERMISSION FROM BLACKWELL SCIENCE

**SOURCE:** WAGNER VALENTI

fer of water from one pond to another is not recommended, because it means poorer water quality conditions in the second (and subsequent) ponds and brings the risk of disease transfer. Ideally, water should be distributed in pipes or open channels by gravity if the topography of the site allows it (Figure 53). Similarly, inlet pipes or channels should be constructed above the water level in the ponds so that the incoming water falls onto the surface of the water (Figure 54). This may be achieved by pumping the water supply to an elevated channel, if this is economically feasible. The water inlet is normally placed at the shallow end of the pond, opposite the discharge point. The inlet channels (or pipes) and the outlet pipes must be correctly sized according to the water demand and draining needs of each pond. Table 12 gives the water discharge capacity of concrete pipes under various pressure heads. Detailed information on these topics is provided in other FAO manuals (FAO 1992b, 1995).

The flow of water into each pond must be controlled by valves, weirs, stop-logs or plugs (Figure 55). Detailed instructions on building these structures are given in FAO (1992b). While gravity supply, elevated water inlets and lack of cross-contamination of water between adjacent ponds represent the ideal, many freshwater prawn farms exist which do not comply with these recommendations. Many farms (due to site, technical, or

TABLE **12** Water discharge capacity (in m<sup>3</sup>/hr) of concrete pipes under various pressure heads

INSIDE DIAMETER OF PIPE (CM)	PRESSURE HEAD (CM)						
	5	10	15	20	25	100	200
20	67	95	116	134	150		
25	105	149	182	210	235	432	576
30	151	214	262	302	338		
35	206	291	357	412	460	684	1 152

**NOTE:** THE WATER DISCHARGE CAPACITY OF PIPES INCREASES WITH THE PRESSURE HEAD (VERTICAL DISTANCE BETWEEN WATER SURFACE ABOVE AND CENTRE OF LINE OF PIPE BELOW).

**SOURCE:** DERIVED FROM FAO (1995)

There are many different ways of controlling the water entering your ponds: these are some examples

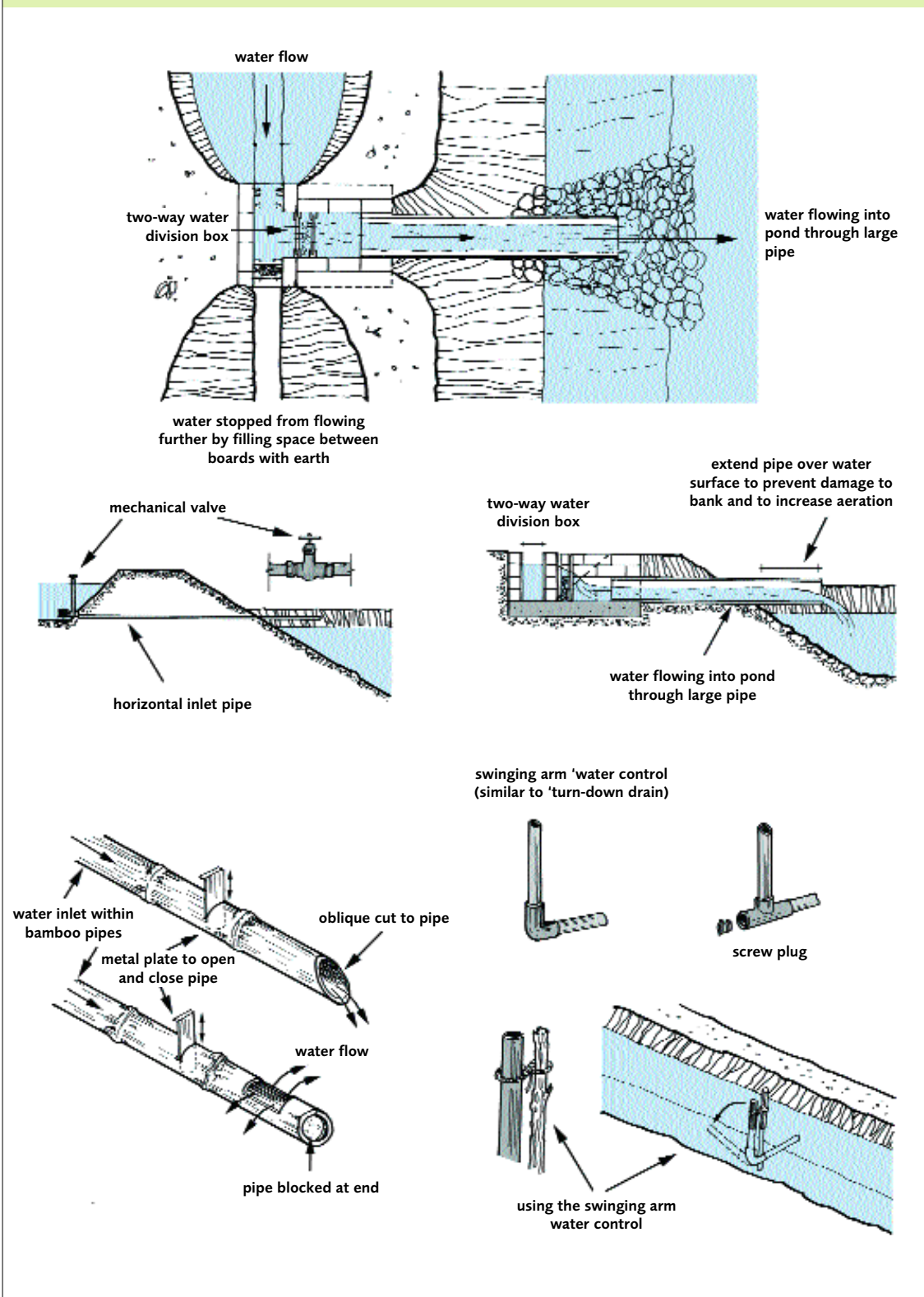

SOURCE: EMANUELA D'ANTONI, AFTER FAO (1992b)

financial limitations) have water inlets below the pond water level and receive water from an inlet channel (or a low-lying area such as paddy fields) with the same water level as the pond. In some cases ponds are directly interconnected. These farms produce freshwater prawns, often profitably. However, the use of such water supplies increases risk substantially; a proper water distribution system is essential for reliable high production.

Methods of minimizing water losses through seepage, by sealing ponds with organic matter, puddling, compaction, laying out a 'soil blanket', bentonite, or lining them with polyethylene, PVC, or butyl rubber sheeting are described in another FAO publication (FAO 1996).

### DISCHARGING WATER FROM THE PONDS

It is preferable to be able to drain ponds by gravity than to have to pump the water out and, where this is possible, you should construct a 'monk' or sluice gate outlet structure. These structures (Figure 56) will allow you easily to control water depth and drainage speed and can be screened to prevent the loss of stock. In flow-through water management, water is continually flowing through this structure. The monk allows you to totally drain your pond and, more importantly, enables you to control the water level during seine harvesting operations, flushing and water circulation.

Static (non-flow-through) ponds can have a simple screened and plugged outlet pipe or a turn-down drain, as previously shown in Figure 40. Outlet structures, whether they are pipes or monks, must be carefully sized so that the pond does not drain too slowly (to prevent poor water quality during harvesting operations), and they should be sited so that the pond can be totally drained (Figures 57 and 58). Table 13 gives the appropriate pipe sizes for ponds with monk outlets, for example, while Table 14 gives the time to drain a pond under various circumstances. Figure 59 is an illustration of a sluice gate structure. The top of the sluice gate should also be constructed at least 50 cm above the highest pond water level as a safety measure. Detailed information on these topics can be found in other FAO manuals (FAO 1992b, 1995).

Where the pond outlet is a pipe below water level, there should also be an overflow pipe inserted about 20-30 cm below the top of the pond bank but above the normal water level in the pond. This overflow pipe should be screened in the same way as the normal pond outlet, to prevent loss of stock. If the water level in the area to which the pond drains also rises, however, the overflow pipe will be ineffective.

**Figure 56**  
The outlet structure, sometimes known as a 'monk', can be used to control the level of the water as well as to screen the water to prevent the loss of freshwater prawns (Brazil)



**SOURCE:** JULIO VICENTE LOMBARDI, REPRODUCED FROM NEW AND VALENTI (2000) WITH PERMISSION FROM BLACKWELL SCIENCE

**TABLE 13** Sizes of outlet pipes for ponds with monks

POND SIZE (m <sup>2</sup> )	INSIDE DIAMETER OF PIPE (cm)
<200	not less than 10
200-400	10-15
400-1 000	15-20
1 000-2 000	20-25
2 000-5 000	25-30
>5 000	40 or more

**SOURCE:** DERIVED FROM FAO (1992b)

TABLE **14** Time taken to drain ponds (in hours) with different drain pipe sizes

INSIDE DIAMETER OF PIPE (cm)	POND AREA (ha)						
	0.1	0.2	0.5	1.0	2	5	10
10	96	192	480				
20	15	30	75	150	300		
50	1.5	3.5	8	16	32	80	
100			2	3.5	7	17.5	35

**NOTE:** THESE FIGURES ASSUME AN INITIAL WATER DEPTH OF 1 M, WITH PIPE VELOCITY LIMITED TO 1 M/SECOND; IF YOU HAVE TWO PIPES, THE TIME FOR DRAINING IN EACH CASE WOULD BE HALVED.

**SOURCE:** DERIVED FROM FAO (1995)

Where drainage by gravity is not feasible because of the limitations of the site, the only way to empty the pond or control its water level is by pumping. A screened 'long-tail' pump is one method of emptying ponds on flat sites (Figures 60 and 61). These pumps are readily available because they are used for paddy-field irrigation.

When water is discharged, enriched water and waste solids should be treated to prevent adverse effects on receiving waters, or to permit some or all of the pond water to be reused at various stages, pumped back for the same ponds, or drained into other systems downstream. Solids removal is the main form of treatment, usually based on sedimentation in settling ponds. Aeration may be used to increase oxygen levels, and algal growth in the settling ponds may help to remove nutrients. Every effort should be made to minimize water exchange, in order to reduce effluent loading and to conserve the water supplies themselves; water is essential to many forms of human activity and its use needs to be responsible.

The topics of harvesting and harvest structures are dealt with later in this manual. More information on outlet structures can be found in Muir and Lombardi (2000) and details about their construction are contained in several other FAO manuals (e.g. FAO 1992b, 1994).

## AERATION

Most prawn farms use water exchange to keep dissolved oxygen levels high, as well as curing other water quality problems. When the original FAO manual on freshwater prawn

farming was written in 1982 it was pointed out that the dissolved oxygen level of incoming water can be enhanced if ripples (Figure 50) are built into gravity inflow channels and water is injected into the ponds above water level (Figure 54). It was also noted that permanent aeration equipment was not normally provided for many freshwater prawn grow-out ponds but that equipment for emergency aeration was useful in times of

**Figure 57**  
Most prawns will have been previously removed by seining; the rest are harvested not only at the drain but also by cast net (as shown in this photo from India) while draining proceeds.



**NOTE:** PIPES HAVE BEEN USED AS PRAWN SUBSTRATES (SHELTERS) IN THIS POND  
**SOURCE:** STEPHEN SAMPATH KUMAR

**Figure 58**  
This freshwater prawn pond has just been totally drained (Thailand)



SOURCE: HASSANAI KONGKEO

oxygen depletion (perhaps caused by an algal crash). However, since that time, aeration has become more commonplace in freshwater prawn farming because the higher stocking densities that are used in some grow-out systems and nurseries increase oxygen demand.

Paddlewheels (Figure 62) are the most efficient method of increasing dissolved oxygen levels in pond water (Table

15). Recently, long shaft engine-run paddlewheel aerators have been developed, which can be operated in remote areas far from power supplies (Figures 63 and 64). Aerators are needed to ensure the water quality necessary for increased productivity (for which maximum growth and survival rates are required) and emergency use, especially after partial harvesting. According to Boyd and Zimmermann (2000), aeration is valuable not only to maintain dissolved oxygen levels sufficiently high at night time (when they are naturally low) but also in the daytime, when they can become low at the pond bottom, where most prawns dwell. These authors noted that the provision of supplementary aeration equivalent to 1 horsepower could increase the productivity of a pond by about 400-500 kg/ha (this observation is based on experience with fish and marine shrimp and has not yet been quantified for freshwater prawns).

The selection of aeration equipment is discussed in another FAO manual (FAO 1996).

### MISCELLANEOUS

In addition to its ponds and its water distribution systems a freshwater prawn farm has the following equipment and facility requirements:

- power;
- roads and access paths;
- accommodation: every farm should have accommodation for some of its workers to live on site;
- fencing: a perimeter fence and, on larger farms, lighting, to deter poachers (human predation);
- storage facilities: dry storage is needed for feeds (or ingredients), chemicals, nets, etc.;

TABLE 15 Oxygen transfer efficiencies of basic types of aerator

TYPE OF AERATOR	AVERAGE OXYGEN TRANSFER EFFICIENCY (kg O <sub>2</sub> /kWhr)
Paddlewheels	2.13
Propeller-aspirator pumps	1.58
Vertical pumps	1.28
Pump sprayers	1.28
Diffused air systems	0.97

SOURCE: BOYD (1990)

- feed distribution and monitoring equipment;
- nets;
- water quality monitoring equipment;
- predator protection; and
- transport: larger farms will need trucks for prawn distribution and feed collection.

# FIGURE 59

Pond outlets need to be screened to prevent the loss of your prawns; this type of structure can be designed to hold screens and to control the flow rate

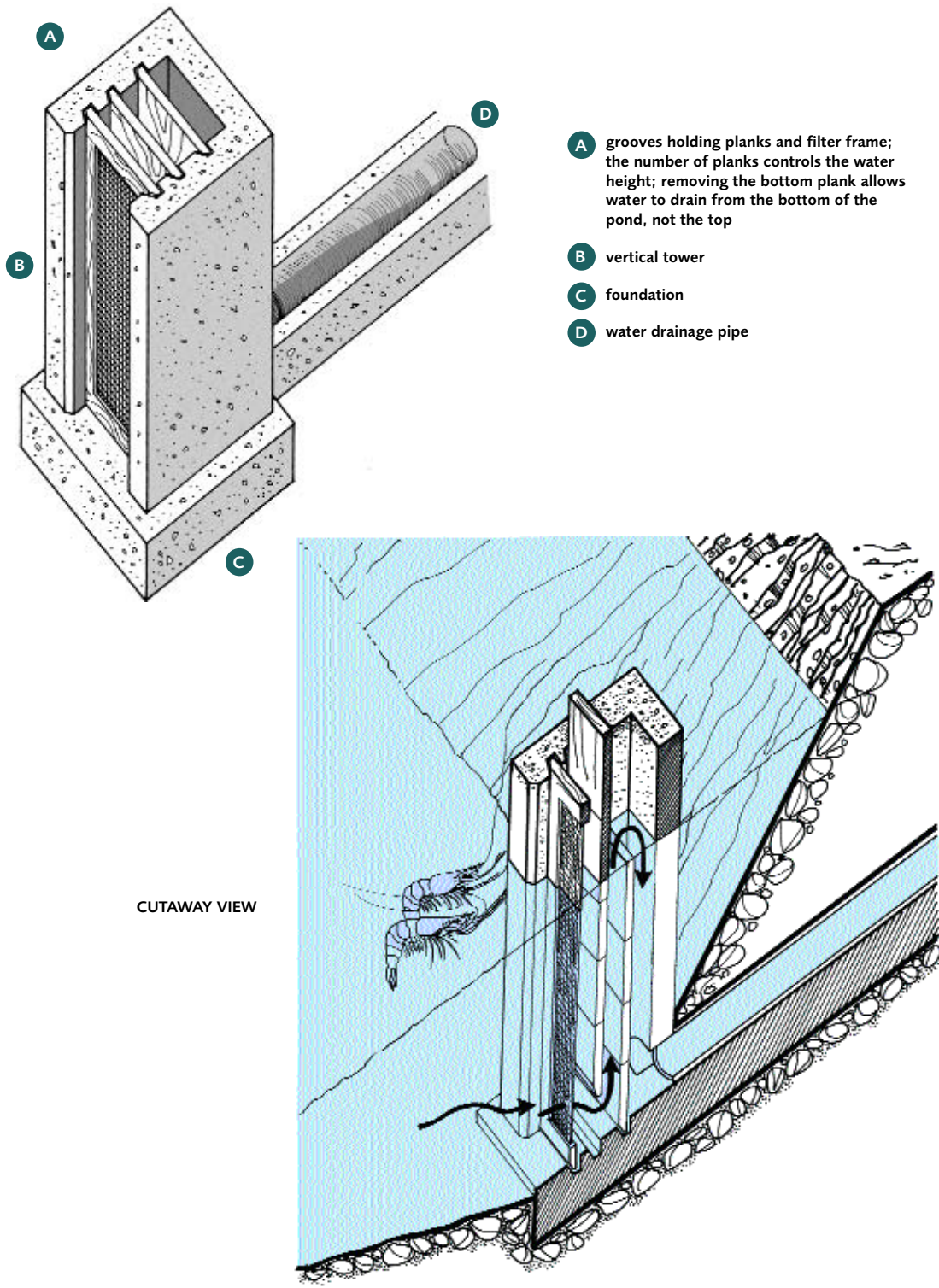

SOURCE: EMANUELA D'ANTONI



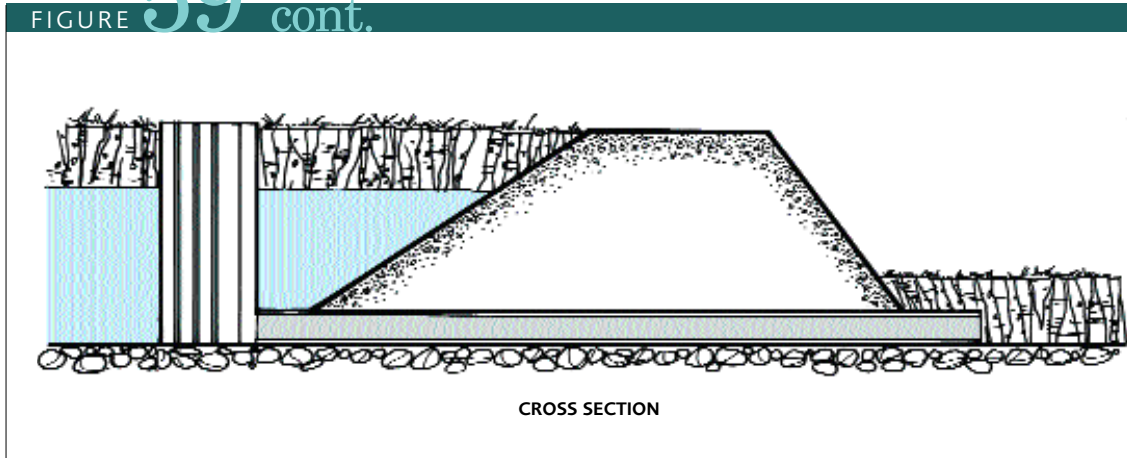

SOURCE: EMANUELA D'ANTONI

## 6.2 Management of the grow-out phase

This section of the manual briefly introduces some general principles of aquaculture farm management. In doing so, it draws heavily upon some other FAO manuals on the management of ponds and water (FAO 1996) and fish (FAO 1998). A simple manual on small-scale freshwater fish farming (FAO 1994) is also available. You are strongly recommended to obtain and read these publications before commencing operations on your prawn farm. This section of this manual concentrates on matters which are specific to the management of freshwater prawn farming and is based on the original FAO manual on this topic, supplemented with material extracted from Boyd and Zimmermann (2000), D'Abramo and New (2000), Johnson and Bueno (2000), Karplus, Malecha and Sagi (2000), Tidwell and D'Abramo (2000), Valenti and New (2000) and Zimmermann and New (2000). Information is provided on the management of the monoculture of freshwater prawns (at various levels of intensity in different climatic zones), as well as their polyculture with other aquatic species and its integration with other types of farming. Harvesting is dealt with later, in a separate section.

**Figure 60**  
Long-tail pumps are easily available in Thailand



**Figure 61**  
Long-tail pump being used to lift water from a Thai irrigation canal into a supply channel for freshwater prawn ponds (this type of pump can also be used to drain ponds by pumping)



SOURCE: HASSANAI KONGKEO

SOURCE: HASSANAI KONGKEO

**Figure 62**  
Using paddlewheel aerators keeps the dissolved oxygen level high enough to increase stocking levels



SOURCE: CLAUDE BOYD

## SIZE VARIATION

The management of size variation is an extremely important aspect of growing freshwater prawns, because of the uneven growth rate of individual prawns, especially males, known as HIG. If you are going to be able to grow prawns in your ponds which have the maximum marketable value and the highest total production rate, it is essential that you understand this topic properly. For this reason a special annex to this manual has been prepared (Annex 8) and you are encouraged to read it carefully.

## SEMI-INTENSIVE MONOCULTURE IN TROPICAL ZONES

Although this section concentrates on the management of prawn monoculture in tropical zones, it also contains information which is equally applicable to other types of freshwater prawn rearing. Freshwater prawn monoculture can be extensive, semi-intensive or intensive but the definition of these terms is rather vague (Valenti and New 2000). For the purpose of this manual, the definitions used are shown in Box 14.

Most of this section of the manual is targeted at the semi-intensive level of intensity (Box 14, Level 2). Semi-intensive freshwater prawn grow-out in ponds can be managed by a 'continuous' or 'batch' system, or a combination of the two, the 'combined system'. A variant of the combined system is known as the 'modified batch system'. These systems are described in Box 15. The system which the grow-out and harvesting sections of this manual is built around is System 3 (the combined system).

## Preparing your pond

Before you stock your pond you need to prepare it. After the final harvest of the last batch of prawns that you reared, the pond should be drained to remove all predators. Make any necessary repairs to the pond banks and the major structures at this time. Check all inlet and outlet screens. Completely dry the pond for 2-3 weeks (this may not be possible

between every cycle, for example in the rainy season, but should be done at least once per year). It is not normally necessary to remove pond sediments from freshwater prawn ponds after every cycle. However, sediment build-up over several batch cycles, or during a long period

**Figure 63**  
Power supplies are not always reliable. Loss of aeration at a critical time of the day and/or when ponds are heavily stocked. This Thai farm is using a mobile engine to drive long-shaft aerators in two adjacent ponds



SOURCE: HASSANAI KONGKEO

**Figure 64**  
Long-shaft  
aerator  
in action  
(Thailand)



SOURCE: HASSANAI KONGKEO

of continuous management (Box 15, System 1), can be excessive (Figure 65). The sediment consists of particles contained in the incoming water, the effects of erosion, the remains of dead pond organisms, prawn faeces, remnants of feed, and exoskeletons cast during prawn moulting. One of the effects of a heavy sediment build-up is a decrease in the volume of water available for the stocked prawns to occu-

py. Scraping the bottom of the pond can be used to remove sediment but care must be taken not to place the excavated sediment where it will wash back into the pond or supply/discharge canals when it rains, or cause a local environmental problem. Site-specific means of sediment removal need to be developed. However, if there is no opportunity to place the

## Definitions of farming intensity used in this manual

BOX 14

### **Level 1: EXTENSIVE FRESHWATER PRAWN CULTURE**

Extensive culture means rearing in ponds (but also in other impoundments such as reservoirs, irrigation ponds and rice fields) which produce less than 500 kg/ha/yr of freshwater prawns. They are stocked, often from wild sources, with PL or juveniles at 1-4/m<sup>2</sup>. There is no control of water quality; the growth or mortality of the prawns is not normally monitored; supplemental feeding is not normally supplied; and organic fertilisation is rarely applied.

### **Level 2: SEMI-INTENSIVE FRESHWATER PRAWN CULTURE**

Semi-intensive systems involve stocking PL or juvenile freshwater prawns (usually from hatcheries) at 4-20/m<sup>2</sup> in ponds, and result in a range of productivity of more than 500 kg/ha/yr and less than that defined as intensive in this box. Fertilisation is used and a balanced feed ration is supplied. Predators and competitors are controlled and water quality, prawn health and growth rate are monitored. This form of culture is the most common in tropical areas.

### **Level 3: INTENSIVE FRESHWATER PRAWN CULTURE**

Intensive culture refers to freshwater prawn farming in small earth or concrete ponds (up to 0.2 ha) provided with high water exchange and continuous aeration, stocked at more than 20/m<sup>2</sup> and achieving an output of more than 5 000 kg/ha/yr. Construction and maintenance costs are high and a high degree of management is required, which includes the use of a nutritionally complete feed, the elimination of predators and competitors, and strict control over all aspects of water quality. This form of culture is not recommended in this manual because it requires more research, particularly on size management.

## Systems of management in grow-out ponds for freshwater prawns

### System 1: THE CONTINUOUS SYSTEM

This involves regular stocking of PL and the culling (selective harvesting) of market sized prawns. There is no definable 'cycle' of operation and the ponds are therefore only drained occasionally. One of the problems of this form of culture, which can only be practised where there is year-round water availability and its temperature remains at the optimum level, is that predators and competitors tend to become established. Also, unless the culling process is extremely efficient, large dominant prawns remain and have a negative impact on the postlarvae which are introduced at subsequent stocking occasions. This results in a lower average growth rate. The decline in total pond productivity (yield) that has been observed when this system has been used for a long time is,

however, not confined to this management system and may also be a function of genetic degradation, as discussed elsewhere in this manual. This results in less and less satisfactory animals being stocked. There are other major problems which occur when ponds are continuously operated (see Figure 65).

The various real or perceived problems of the continuous management system were not obvious when the original FAO manual on freshwater prawn farming was revised. In its first English edition (New and Singholka 1982) the authors mentioned the continuous system but specifically omitted any details about it because they thought that it might be wrongly interpreted as a recommendation for application in all circumstances. However, following requests for details, the authors included detailed information on this

topic in its revision (New and Singholka 1985); this information was also included in its French and Spanish editions. In view of the experience gained in the 17 years since this information was published, the long-term continuous management system is not now recommended and the annex providing details about it has therefore been omitted in the current manual.

### System 2: THE BATCH SYSTEM

At the other extreme to the continuous system is the batch system, which consists of stocking each pond once, allowing the animals to grow until prawns achieve the average market size, and then totally draining and harvesting it. This reduces predator and competitor problems. However, although dominant prawns cannot impact on newly-stocked PL (because

sediment elsewhere, it can be spread in a thin layer over the pond bank surfaces and allowed to dry until it cracks.

You should till (harrow) the bottom of your ponds during the drying period to increase the oxygen content of the soil, especially if it has a heavy texture (clays and clay loams). A disc harrow (Figure 66) is the best equipment to use and tilling should take place while the soil is still wet but is dry enough to support the weight of the tractor. Where there has been a severe disease problem in the previous crop, you should spread 1 000 kg/ha of agricultural limestone ( $\text{CaCO}_3$ ) or 1 500 kg/ha of hydrated lime [sometimes called slaked lime –  $\text{Ca(OH)}_2$ ]. It is better if you use agricultural limestone. The use of slaked lime, or quick lime ( $\text{CaO}$ ) may increase the subsequent pH of the water above tolerance limits if prawns are stocked (as is recommended for other reasons later) soon after the ponds are filled. After adding agricultural limestone you should sun-dry the ponds for at least two weeks so that toxic gases such as hydrogen sulphide and methane are voided. Some freshwater prawn farms make a standard application of 1 000 kg/ha of agricultural limestone every time a pond is drained. Chlorination can

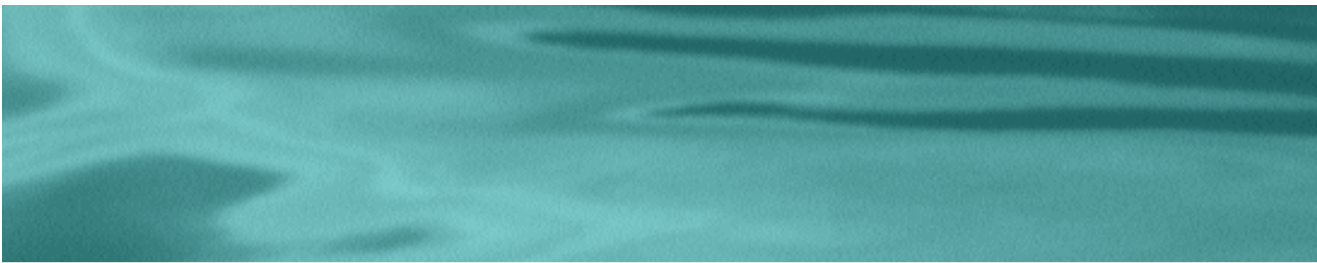

there is only a single stocking), the problem known as heterogeneous individual growth (HIG) remains. This term (HIG) refers to the fact that freshwater prawns do not all grow at the same rate. Some grow much faster, tend to become dominant, and cause stunted growth in other prawns. This bland statement is a simple summary of a very complex phenomenon, which is explained in more detail in Annex 8.

### **System 3: THE COMBINED SYSTEM**

This provides the advantages of reduced predator and competitor problems of the batch system with the cull-harvesting employed in the continuous system, to reduce the problems of HIG. In the combined system, ponds are stocked only once. Cull-harvesting starts when the first prawns reach market-size

(the exact size depends on the local, live sales, or export market requirements). This removes the fast-growing prawns for sale, leaving the smaller ones to grow, with less HIG impact. Eventually, after several cull-harvests, the ponds are drained and all remaining prawns harvested. The total cycle usually lasts about 9-12 months in tropical regions, depending on local conditions. This system is recommended in this manual.

### **System 4: THE MODIFIED BATCH SYSTEM**

This more complex management regime was developed in Puerto Rico (Alston and Sampaio 2000) and involved three phases. After 60-90 days in a 1 000 m<sup>2</sup> nursery pond stocked at 200 to 400 PL/m<sup>2</sup>, 0.3-0.5 g juveniles were harvested and stocked at 20-30/m<sup>2</sup> into empty

(without any existing prawns present) 'juvenile' ponds. After another 2-3 months, seine harvesting of these juvenile ponds began and was repeated every month after this. These harvests removed animals of 9 to 15g, which were then stocked into 'adult' ponds with existing populations of small prawns. The juvenile ponds were themselves then either converted to adult ponds, to allow remaining animals to grow to marketable size, or were drained and refilled for further use. According to the owner of the farm (J. Glude, pers. comm. 1998), drain-harvesting into a catch basin, instead of seining, would have reduced labour costs and increased survival. Further advantages could have been obtained if postlarvae had been held longer in the nursery ponds and then graded into at least two size groups before stocking into juvenile ponds.

also be used for disinfection (see Boyd and Zimmermann 2000) but it is not recommended because it is a much more expensive treatment.

If your pond has previously been stocked with fish and you want to convert it to freshwater prawn culture, or if a lot of fish were present during your last prawn grow-out season, treat it with a piscicide after harvesting and while it still has water in it. Rotenone or teaseed cake are commonly used for eradicating unwanted fish between cycles. They are effective if spread evenly throughout the pond. However, the use of rotenone is banned in some countries because of environmental concerns: check before you use it. The quantities needed for treatment are shown in Box 16.

More powerful chemicals, such as insecticides, are sometimes used for pest eradication (in severe cases, where there are very stubborn predators or competitors that resist other forms of treatments and/or because of their cheapness). However, the use of insecticides to remove unwanted fish is not recommended in freshwater prawn farms; they are potentially toxic to prawns and may accumulate in prawn tissues, with consequential dangers to human

**Figure 65**  
The sediment in continuously operated freshwater prawn ponds can become so deep that it reduces the water volume and depth and disturbs the drainage pattern; this pond had not been drained for many years (Hawaii)



SOURCE: SPENCER MALECHA

and penetrates the soil. Routine liming should be sufficient to increase total alkalinity to about 40 mg/L. The quantity of lime required depends on the type of soil and the pH. Agricultural limestone is the best compound to use for increasing alkalinity. First, measure the soil pH as shown in Box 17.

Table 16 shows the quantity of lime to use in treating pond bottoms between cycles. Spread the limestone uniformly before fertilizers are applied. Liming may be necessary every time the pond is drained if it is managed with a rapid water exchange. Judge the need by testing the water before draining. If the pond water contains less than 30-40 mg/L of alkalinity it will be necessary to lime. If it is more than 60 mg/L it should not be limed.

You are not recommended to build ponds on suspected acid sulphate soils because

making them usable is expensive, time consuming and laborious. Despite this advice, some people build ponds on such soils! If you have inherited or bought such ponds, you will find that correcting the pH by liming the pond bottoms is usually impractical, due to their high lime requirements. In such cases, liming should be limited to the banks of the pond and combined with the planting of acid resistant grasses, such as the African star grass. Continuous flushing of the water through the ponds and over the banks of the ponds, followed by drying, accelerates the reclamation process of this type of pond. The period required to correct pH may vary between a few months and several years, depending on soil and climatic characteristics.

BOX 16

## Application of rotenone and teaseed cake

### ROTENONE:

20 g/m<sup>3</sup> (200 kg/ha when the water averages 1 m deep) of rotenone powder (which contains 5% rotenone, usually from Derris roots, and thus equivalent to applying 1 g/m<sup>3</sup> of pure rotenone) is the normal dose. Rotenone needs to be mixed in water and the solution kept well-mixed while it is applied.

### TEASEED CAKE:

The application of teaseed cake (containing 10-13% of saponin) at a dose of 50-70 g/m<sup>3</sup> (500-700 kg/ha when the water depth averages 1 m) is adequate to remove unwanted fish. Teaseed cake needs to be prepared by drying and finely grinding the seeds, soaking the powder in lukewarm water for 24 hours, and diluting the suspension before mixing it evenly into the pond water.

TABLE 16 | Lime requirements for treating the bottom of ponds between cycles

SOIL pH	AGRICULTURAL LIMESTONE REQUIREMENT (mt/ha AS CaCO <sub>3</sub> )		
	CLAYS OR HEAVY LOAMS	SANDY LOAMS	SAND
<4.0	14.32	7.16	4.48
4.0-4.5	10.74	5.37	4.48
4.6-5.0	8.95	4.48	3.58
5.1-5.5	5.37	3.58	1.79
5.6-6.0	3.58	1.79	0.90
6.1-6.5	1.79	1.79	nil
>6.5	nil	nil	nil

SOURCE: DERIVED FROM BOYD AND TUCKER (1998)

So far, in this section of the manual, it has been low pH that has been discussed. Ponds having a high water pH can be improved by ‘ageing’. This means filling them with water 2-4 weeks before stocking and allowing natural biological processes to buffer the pH. However, doing so also increases predator and competitor problems, as discussed before.

If your water supply is very soft, you can increase its hardness by adding calcium sulphate (gypsum). Information drawn from Table 5 suggests that a total hardness of around 50-100 mg/L (CaCO<sub>3</sub>) would be ideal for freshwater prawn grow-out. If the pond water before draining shows levels lower than this, gypsum should be added during pond preparation. 2 mg/L of gypsum is required to increase total hardness by 1 mg/L. Thus, if the total hardness is 20 mg/L before treatment, 600 kg of gypsum/ha (for ponds with an average water depth of 1 m) should be applied to correct it to 50 mg/L. No treatment is suggested for hard water but, if the procedures for site selection have been followed properly, excessively hard water should not be present in freshwater prawn ponds.

Some soils may benefit from the application of nitrates to oxidize the soil and aid the decomposition of organic matter where pond bottoms cannot be completely dried out. For most ponds 150-200 kg/ha of sodium nitrate would be sufficient. Calcium peroxide is also sometimes used for this purpose but is less efficient and is not recommended.

Some farms use organic fertilisation, Manure is used for fertilising ponds, before and during the rearing cycle, where freshwater prawns are grown with silver and bighead carps in China. In Brazil, freshwater prawn ponds are often fertilized between cycles using

1 000-3 000 kg/ha of cattle manure or other organic material. This increases the benthic fauna, which become an important feed for PL and juveniles. However, this practice is not encouraged in this manual for the reasons shown in Box 18.

If you are really convinced that organic fertilisation between cycles is helpful, use plant meals, such as soybean meal or rice bran, not animal manures. Generally, the productivity of

Figure 66  
The bottoms of ponds can be tilled with a disc harrow (USA)



SOURCE: CLAUDE BOYD

## Measuring soil pH

**T**ake 10-12 samples of the upper 5 cm layer of the soil, before any soil treatment has been applied, dry them in an oven at 60°C, and pulverize them to pass a 0.085 mm screen. Bulk the samples together and mix 15 g of the pulverized soil with 15 ml of distilled water. Stir occasionally for 20 minutes and measure the pH, preferably with a glass electrode. The hand-held pH-soil moisture testers used by some farmers are not accurate enough (Boyd and Zimmermann, 2000).

ponds improves as they get older and as a rich bottom area and grassy banks are established. Further reading on pond preparation can be found in Boyd and Zimmermann (2000).

### Stocking

It is better to stock ponds immediately after filling them with filtered water. This has no predators and causes no photosynthetically-induced pH changes. There may be a slight reduction in growth from the initial lack of natural food, but increased survival will outweigh this factor. Stocking the ponds quickly reduces the amount of competitors and predators, which have less time to become established. Often postlarvae (only about a week or two old after metamorphosis) are used to stock grow-out ponds, where they will remain until harvesting. Some farmers prefer to use PL reared in a simple (in contrast to a sophisticated) hatchery, believing them to be more hardy because the strongest have been naturally selected.

Juveniles are more tolerant of high pH and ammonia than PL and there are some advantages in stocking juveniles (Figure 67) instead of PL, even in tropical areas. Juveniles are more expensive to produce in nurseries, or to purchase from others, but the improved grow-out survival and shorter time to marketable size achieved should more than balance this out.

The transport of PL (or juveniles) to the grow-out site has already been described in this manual. On arrival at the pond bank you should take great care to acclimatize the PL to the temperature of the pond water by floating the transport bags in the pond for 15 minutes (Figure 68) before emptying them into the water (Figure 69). Severe mortalities can be caused not only by thermal shock but also by sudden changes in pH. You should measure the pH of the pond water before stocking. If it is more than 0.5 pH units different from the pH in the PL holding tank or the nursery ponds, acclimatize the PL to this pH level slowly (over a one-day period) in the hatchery-nursery before transporting and stocking them at the grow-out site.

The stocking rate you need to use depends on the size of the animals you will eventually be selling (and thus on the demand of the local, national, or international market that you

are targeting), on the length of the growing season (determined by water availability and temperature), and on the management system you are using. Older ponds tend to be more productive than new ones. Your decisions about stocking rate should consider all these factors. Specific stocking densities are not recommended in this manual because no guarantee can be given that a certain quantity of prawns will be produced! As stated in Box 14,

**Figure 67**  
There are some advantages in rearing freshwater prawns (*Macrobrachium rosenbergii*) to a larger (juvenile) size before stocking



SOURCE: DENIS LACROIX



**Figure 68**  
Sudden changes in temperature and pH can cause mortalities when prawns are stocked. Before their release, the bags containing the postlarvae should be floated in your pond to bring the temperature within them gradually to that of the pond. Any adjustments to the pH of the transport water should have been made in the hatchery, before transport (Brazil)



**SOURCE:** PATRÍCIA MORAES-RIODEADES

semi-intensive stocking rates vary between 4 and 20 PL/m<sup>2</sup> (40 000-200 000/ha). The lower stocking rates will tend to result in prawns of a larger average size. Higher stocking rates tend to result in greater total productivity (mt/ha/crop) but smaller average prawn size. The stocking rate you choose should therefore be adjusted according to your previous experience in your farm or locality, and the size of marketable animals desired. If you are stocking juveniles, there are some advantages in grading them before stocking, as discussed later.

The postlarvae (PL) you have purchased and brought to your pond-site will have been counted into the transport bags at the hatchery. You may wish to be present at that time to ensure fairness. Normally, hatcheries will put more PL into the bags, rather than underestimate them. However, if you are receiving PL without having seen them packed, it is advisable

for you to count the contents of one or two bags at random to check the accuracy of the delivery. If a standard number of PL are packed into each transport bag the stocking procedure will be easier because it is only necessary to count the number of bags to achieve the desired density.

In some countries (e.g. Bangladesh, India, Viet Nam), hatcheries currently have insufficient capacity to supply all grow-out requirements. In these cases, wild-caught PL or juveniles are often used for stocking ponds (New 2000b). This practice is not recommended because of the possibility of introducing prawns of other species, disease organisms, and predator fish, as well as the effect that excessive fishing of these young stock causes to the natural freshwater prawn fishery. Every effort needs to be made to increase hatchery capacity for a healthy freshwater prawn farming industry. However, it is recognized that catching prawn (and shrimp) juveniles provides considerable rural employment and any transition from the use of wild-caught to hatchery-reared PL and juveniles should be carefully phased to minimize socio-economic problems.

Postlarval freshwater prawns obtained from foreign hatcheries are sometimes used to stock grow-out ponds. Take care in making introductions from another locations; seek the advice of your local animal health expert on this subject before you do this.

Postlarval freshwater prawns obtained from foreign hatcheries are sometimes used to stock grow-out ponds. Take care in making introductions from another locations; seek the advice of your local animal health expert on this subject before you do this.

### Increasing surface area and routine pond maintenance

Ponds need to be well-maintained during the farming period. You should take special care about the prevention and treatment of pond bank erosion and

## Reasons for not applying organic fertilizers

BOX 18

### ORGANIC FERTILIZERS:

- **VARY** in composition.
- **HAVE** a low nitrogen and phosphorus content and therefore have to be applied in large quantities.
- **CREATE** an oxygen demand in the pond water.
- **LEAVE** organic residues on the pond bottom.
- **PROVIDE** detritus that becomes a starting point for the growth of filamentous algae.
- **MAY** contain high concentrations of heavy metals.
- **MAY** be contaminated with antibiotics.

the maintenance of water inlet and outlet structures, particularly the filters (screens, socks). You can increase the pond surface area available to the prawns by placing rows of netting, suspended from floaters and weighed down with sinkers, across the pond. You can also use the sort of substrate that is described in the next section of this manual, on culture in temperate zones. Twigs, pipes, bricks, etc. are often used as prawn habitats but they interfere with harvesting, and are not recommended.

As mentioned before, vegetation along the pond bank minimizes erosion. Below the water line, it also provides food and a habitat for the prawns. The plants *Elodea* spp. and *Hydrilla* spp. make a good substrate for prawns. You must be careful not to allow the growth of these plants to become so excessive that it interferes with harvesting. Maintain the pond depth at an average of 0.9 m. Do not allow extensive shallow areas to develop, or rooted aquatic plants will grow extensively on the pond bottom (Figure 70). The growth of rooted aquatic plants and benthic algae must also be discouraged by management practices that encourage significant growth of phytoplankton, thus reducing light penetration to the pond bottom. The tips in Box 19 will help you.

### MONOCULTURE IN TEMPERATE ZONES

Special conditions apply to the culture of freshwater prawns in ‘temperate zones’, because of the short period during which the grow-out phase can be operated (usually about 4-5 months). A captive broodstock has to be maintained, an indoor heated hatchery operated, and postlarvae reared to juvenile size in indoor nurseries. This is necessary to provide larger animals for stocking grow-out facilities as soon as possible in the season, thus enabling the longest possible growing period. The highest possible average weight at harvest can be achieved in this way. These topics are fully discussed by Tidwell and D’Abramo (2000).

In the temperate zone culture of freshwater prawns, natural food, enhanced by feeding or fertilisation, is used until the prawn biomass reaches about 200-250 kg/ha. After that, supplemental feeding is essential. The use of a range of diets, both for initial fertilisation and as a feed for prawns, is discussed later in this manual. Aeration may be necessary to maintain satisfactory levels of dissolved oxygen. Although average water temperatures during grow-out in temperate zones may be much lower than in the tropics, the maximum may become quite high (over 30°C). Dissolved oxygen levels decline as temperatures rise (Table 7).

Without using substrates to increase productivity, a stocking rate of about 4 juveniles/m<sup>2</sup> (40 000/ha) is recommended for the monoculture of *Macrobrachium rosenbergii* in temperate zone ponds. There are some advantages in using larger juveniles for stocking.

**Figure 69**  
When the temperature in the bag is the same as in your pond, the postlarval *Macrobrachium rosenbergii* can be released (Brazil)



SOURCE: PATRÍCIA MORAES-RIODEDES

**Figure 70**  
Grass is invading the shallow areas of this pond (Brazil)



SOURCE: PATRÍCIA MORAES-RIODEDES

## Keeping rooted plants out of your ponds

BOX 19

- ⊙ **DO NOT** construct ponds with extensive shallow areas.
- ⊙ **NEVER ALLOW** a shallow amount of water to remain in a pond when it is not in use. Drain it properly. 'Weeds' grow much better in shallow water and predators such as crabs thrive.
- ⊙ **MAINTAIN** an adequate phytoplankton bloom in the pond by feeding and/or fertilisation. This will reduce the light intensity at the bottom of the pond.
- ⊙ **CUT** any vegetation at emergence level. Pulling up the roots usually causes dangerous levels of turbidity in the pond. This job is very time- and labour-consuming and should not be necessary if the pond has been well constructed and managed.

For example, it has been demonstrated that increasing the average stocking weight at 4 animals/m<sup>2</sup> from 0.17 g to 0.75 g increases production at harvest by nearly 30%. However, this stocking size advantage does not apply indefinitely; research has shown that stocking 3 g animals did not improve production because the animals matured too rapidly.

Grading nursed juvenile prawns before stocking also has significant advantages. In temperate zones it has been found to increase average harvest size and total pond production. Size grading is a way of separating out the faster growing prawns and lowering the suppression of growth that they cause to other prawns; it can also result in improved feed conversion ratios (FCR). Some notes on size grading are given in Box 20 but you should note that this procedure is still in the developmental stage. You may need to experiment to refine the technique.

Another means of improving results in temperate freshwater prawn culture is to place artificial substrates in the ponds, which makes it feasible to increase stocking rates above the level recommended earlier for ponds without substrates. PVC fencing (such as is used to close off areas when roads are being resurfaced) forms an ideal substrate (Figure 71). This material can be expensive in some countries but the investment should be worthwhile, as

the following information indicates. Substrate provision on a commercial scale (Figures 72 and 73) has resulted in production and mean harvest size exceeding 1 800 kg/ha/crop and 35 g respectively, from a stocking rate of 4 PL/m<sup>2</sup>, while yields exceeding 2 500 kg/ha/crop with average weights of >40 g have been consistently achieved at a stocking rate of 64 500/ha (Tidwell and D'Abramo, 2000). It is therefore suggested that you increase the stocking rate of juveniles from the 4/m<sup>2</sup> (40 000/ha) recommended earlier for use without substrates to 6.5/m<sup>2</sup> (65 000/ha) when you use either horizontal or vertical substrates. No extra labour (apart from its initial installation) is necessary if this form of substrate is used

**Figure 71**  
Close-up of material used as pond substrate for *Macrobrachium rosenbergii* culture (USA)



**Figure 72**  
Substrates have been placed vertically in this temperate zone rearing pond for *Macrobrachium rosenbergii* culture (USA)



SOURCE: CHARLES WEIBEL

SOURCE: CHARLES WEIBEL

**Figure 73**  
In this temperate zone rearing pond the substrates have been placed horizontally (USA)

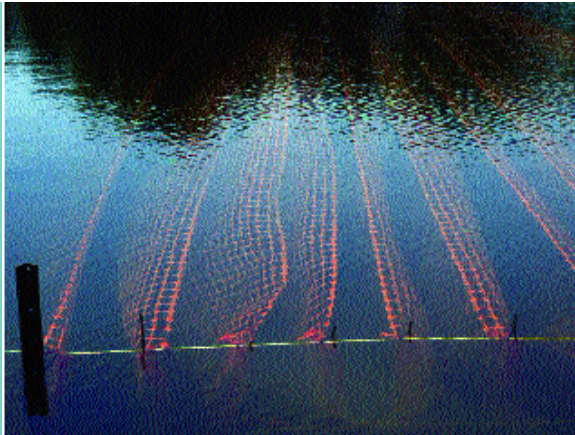

SOURCE: CHARLES WEIBEL

because it can be permanently installed in ponds equipped with catch-basins at the drain end. As the water is drained, prawns abandon the substrate and follow the water flow to the catch basin. You can spread the cost of the labour for installation, as well as the substrate material itself, over several production cycles. This new technology is still being developed but it clear that the use of substrates can marked-

ly increase the productivity of freshwater prawn farming.

Experimental trials of a combination of grading and the use of these substrates has recently (2001) shown that a production of nearly 3 000 kg/ha/crop can be obtained, with animals averaging 52 g (J.H. Tidwell, pers. comm. 2001). At the time this manual was being prepared (2001) work was ongoing to see if this research finding could be verified in commercial temperate-zone ponds.

These types of management make prawn production feasible in smaller, deeper ponds which were previously considered unsuitable. This is useful in hilly inland regions where suitable sites for large shallow ponds are very limited. Grading before stocking and the use of substrates has not been practised much in tropical monoculture yet but the

## BOX 20

### Size grading

**P**LACE A FLOATING grader box (these are commercially available for finfish grading) into a holding tank.

Trial and error is necessary to select the size of the grader bars to use. Your choice will depend on the size of the animals you want to grade. The efficiency of the procedure is a function of the average size of the population to be graded, how variable the size range of that population is, and the average weight and proportion of the total that you wish to achieve in the two graded por-

tions. For example, prawns with an average weight of about 0.6 g can be separated into two portions with size #13 bar graders (13/64 inch; 5.16 mm) and #14 bar graders (14/64 inch; 5.55 mm).

Net the juveniles from the nursery tanks and pour them through the grader. Smaller animals will pass through the parallel bars of the grader and the larger ones will be retained above the bars.

The grading process can be speeded up by causing water movement (water flow, moving the box,

airstones) but it is important not to overload the box because this will cause the juveniles to stack up and they will not actively try to swim out of the grader. Over-crowding may also cause mortalities to occur.

It is recommended that the juveniles be graded into equal (50:50) numbers of upper and lower sized individuals. These should be reared in separate ponds to achieve the best average yield of marketable prawns from the total area of the two ponds.

advantages obtained in temperate culture should be transferable. One researcher believes that up to 9 mt/ha/yr of 20g prawns from three 4-month cycles might be achieved in tropical areas using the combination of grading and substrates (W. Valenti, pers. comm. 2001).

## POLY CULTURE AND INTEGRATED CULTURE

A considerable, but unquantified proportion of global freshwater prawn production comes from polyculture and integrated culture. No detailed recommendations for the polyculture of *Macrobrachium rosenbergii* with other species, or its integration into other farming activities, have been provided in this manual. This is because there is no single recommendable process. Many different management techniques are possible. It is hoped, however, that you will be stimulated by the examples given below to try polyculture with locally available species, as well as integration with other farming activities in your specific location. Further reading on this topic is available in Zimmermann and New (2000) and New (2000b).

### Polyculture

Records exist of the polyculture of various *Macrobrachium* species in combination with single or multiple species of fish, including tilapias, common carp, Chinese carps, Indian carps, golden shiners, mullets, pacu, ornamental fish, and red swamp crayfish. Other combinations may be feasible.

The inclusion of freshwater prawns in a polyculture system almost always has synergistic beneficial effects, which include:

- more stable dissolved oxygen levels;
- the reduction of predators;
- coprophagy (the consumption of fish faeces by prawns), which increases the efficiency of feed;
- greater total pond productivity (all species); and
- the potential to increase the total value of the crop by the inclusion of a high-value species.

However, the management of a polyculture system is more complex. This particularly applies to the harvesting of prawns. Some large fish can be cull-harvested from a polyculture pond but this interferes with the culture of the prawns. Prawn-fish polyculture systems are therefore normally batch-harvested. It is difficult to synchronize fish production with prawn production to achieve the maximum production of marketable animals. For this reason, most polyculture systems involving freshwater prawns concentrate management on the production of the fish and regard the harvested prawns as a high-value bonus.

The addition of prawns to a fish polyculture system does not normally reduce the quantity of fish produced. On the other hand, the addition of fish to a prawn monoculture system markedly increases total pond yield but may reduce the amount of prawns below that achievable through monoculture. Some problems have been reported. For example, tilapia which were inadvertently introduced into prawn ponds in Hawaii were described as a pest, causing serious competition for food. Escaped tilapia, which had been grown in cages in freshwater prawn ponds in Puerto Rico took years to eradicate. However, this problem could be avoided by the use of artificially incubated sex-reversed caged tilapia. The monoculture *versus* polyculture decision is site-specific and depends on economic factors, namely balancing the relative market values of the various species with the costs of a more complex management system.

Fish are faster than prawns in accessing any supplemental feed which is presented, so the feeding for polyculture systems is normally directed at the fish, not at the prawns.

TABLE 17 | Average stocking densities and yield of carps, tilapias and freshwater prawns reared in polyculture, based on a literature study

SPECIES		AVERAGE STOCKING RATE (No./ha)	AVERAGE YIELD (kg/ha/yr)
Freshwater prawns	PL	40 000	1 050
	Juveniles	20 000	1 350
Tilapias	<i>Oreochromis niloticus</i>	11 000	5 000
	<i>O. aureus</i>	2 500	1 500
	<i>O. hornorum</i>	3 800	2 100
	Hybrids	6 000	4 800
Carps	<i>Ctenopharyngodon idella</i>	80	2 000
	<i>Aristichthys nobilis</i>	550	1 200
	<i>Hypophthalmichthys molitrix</i>	2 000	2 600
	<i>Cyprinus carpio</i>	4 000	4 000

SOURCE: DERIVED FROM ZIMMERMANN AND NEW (2000)

The prawns consume feed which falls to the bottom of the pond, as well as fish faeces and nutrients derived from detritus. Though commercial fish feeds are sometimes applied, tropical polyculture systems often use simple mixtures of rice bran with plant oilcakes, such as mustard and groundnut. Since there are so many potential combinations of fish and freshwater prawns, it is impossible to give firm guidelines on management in this manual. In the cases summarized in Table 17, the culture cycles ranged from 3 to 6 months and the water temperatures were  $26 \pm 4^\circ\text{C}$ . This table also gives an indication of the productivity obtainable. The results of other published studies on prawn and fish polyculture have been reviewed by Zimmermann and New (2000). Much of the output of *M. rosenbergii* produced in China comes from polyculture systems. Examples are given in Box 21.

### Integrated culture

The wastewater from ponds containing prawns being reared in monoculture or polyculture with fish can be used for the irrigation of crops. Prawns can also be reared in paddy fields, without depressing rice production. This has proved especially valuable in Viet Nam, where it has been shown that the income from prawns in integrated rice-prawn culture can be two or three times as great as that from the cultivation of rice. The introduction of freshwater prawns reduces the area devoted to rice paddy (because deeper areas where prawns can shelter when the ricefield is dry have to be provided). It also reduces weeding costs (prawns eat weeds) and fertilisation costs. Figure 74 illustrates a Vietnamese rice-prawn farm where peripheral canals have been constructed for *Macrobrachium* culture and a bamboo structure has been erected on the canal dykes to support cucumbers.

Similar to polyculture, no single management strategy can be recommended for integrated culture because the potential combinations are almost infinite. However, examples from Viet Nam have been presented in Box 22.

### Other forms of rearing prawns

The use of concrete ponds, cages (a floating structure, usually enclosed in nylon netting) and pens (an area of a larger water body, such as a reservoir or lake, which is separated off by the use of netting, bamboo or other structures) has not found favour in freshwater

## Polyculture of freshwater prawns with carps in China

### GENERAL MANAGEMENT

#### CONDITIONS:

The pond size ranges from 0.2 to 0.7 ha, with a water depth of 1.2-1.5 m. Dissolved oxygen is maintained at about 3 ppm. Ponds are treated between cycles by sun-drying for 3-5 days and the application of quicklime (CaO) at 900-1 125 kg/ha for pest eradication. Fermented organic manure (often chicken manure) is applied to the ponds at 750-1 500 kg/ha, 7-10 days before stocking. Additional quantities of the same manure are applied one or two times each month. The amount is adjusted according to the fertility of the water and the climatic conditions. Shelters for the prawns, in the form of aquatic weeds, grasses and tree branches are placed in the ponds. Carnivorous and omnivorous fish are not grown with prawns. Bighead and silver carp are the usual species of choice.

The time of stocking depends on the location. It is done when water temperatures reach 20°C; this

occurs in mid-April in southern China and mid-May in central China.

The rearing period is 4-6 months (one cycle per year). Partial seine harvests are taken but the ponds are totally drained before the water temperature drops below 18°C. An average prawn market size of 20 g is sought. Fish are removed with large mesh size nets before drain harvesting occurs. Feeds include soybean meal, groundnut cake, wheat bran, a 35% protein pelleted feed, trash fish, molluscs, silkworm pupae, earthworms, and animal entrails. Feeding rates vary from 15-20% of body weight when the prawns are <1 g, decreasing gradually to 5-6% when the prawns are >10 g. 70% of the daily feed ration is given in a late afternoon feeding and 30% in the morning. The food is spread evenly around the pond about 2 m from the bank.

#### STOCKING AND PRODUCTION RATES WHEN THE EMPHASIS

#### IS ON FRESHWATER

#### PRAWN (*M. ROSENBERGII*)

#### PRODUCTION:

Freshwater prawns are stocked as 1.0-1.2 cm juveniles at 16.5-22.5/m<sup>2</sup>, or as 1.5-2.0 cm juveniles at 15-18/m<sup>2</sup>. Silver and bighead carps are stocked at 1 500-1 800/ha at a size of 12-15 cm. Production of prawns ranges from 1 500 to 3 000 kg per crop. Production of carp ranges from 750 to 1 500 kg per crop.

#### STOCKING AND PRODUCTION RATES WHEN THE EMPHASIS

#### IS ON CARP PRODUCTION:

Freshwater prawns are stocked as PL at 24-30/m<sup>2</sup>, or as 1.0-1.2 juveniles at 4.5-9.0/m<sup>2</sup>, or as 1.5-2.0 cm juveniles at 3-6/m<sup>2</sup>. Silver and bighead carps are stocked at a size of 3-4 cm at 16.5-21/m<sup>2</sup>. Production of prawns ranges from 450 to 750 kg/ha/crop. Production of carp ranges from 5 000 to 7 500 kg/ha/crop of fingerlings (12-15 cm body length).

SOURCE: MIAO WEIMIN (PERS. COMM. 2001)

prawn culture, although there were some early attempts, especially in Thailand. However, nets are sometimes used in nursery systems, as noted earlier in this manual. Many attempts have been made to rear freshwater prawns under highly intensive grow-out conditions in tanks housed under environmentally controlled conditions in cool temperate zones, including the UK. Such ideas have been abandoned due to excessive costs, especially for heating. Indoor rearing in environmentally controlled conditions is now confined to broodstock and nursery systems designed to maximize production in the temperate zones of China and the USA, for example.

## 6.3 Feeding and fertilization

This section of the manual concentrates on practical feeding in the grow-out stage, and some farm-made feeds for freshwater prawns are described in its tables. The feeds and feeding strategies given apply equally to prawns reared in nursery facilities. Detailed information on the nutritional requirements of this species can be found in D'Abramo and New (2000), and on the digestive system in Ismael and New (2000). Feeding strategies for broodstock and feeds and feeding strategies for the larval stages of freshwater prawns have been discussed earlier in this manual.

It is necessary to maintain an adequate phytoplankton density, to provide cover and control the growth of weeds in freshwater prawn ponds. This is done by encouraging the

growth of phytoplankton.

However, it is often unnecessary to fertilize, because this is rapidly achieved by the feeding regime. However, ponds built in a sandy-clay soil may require fertilization for this purpose. Where necessary, 25 kg/ha/month of triple superphosphate ( $\text{Na}_3\text{PO}_4$ ) will keep the water green. Benthic fauna are very important features in the ecosystem of freshwater prawn ponds, forming part of the food chain for prawns. Fertilisation to

encourage the development of benthic fauna is therefore recommended. Animal manures have been used for this purpose (e.g. 1 000-3 000 kg/ha of cattle manure) but the use of animal manure is not encouraged in this manual, for the reasons explained in Box 18. Animal manures can be substituted by other organic materials, such as distillery by-products or other plant residues. The rest of this section of the manual is devoted to the use of feeds.

### FEED TYPE

You can get a small production level of freshwater prawns (perhaps 200-300 kg/ha/year, as shown in Box 14, Level 1) by relying on the natural productivity of the ponds. However, successful semi-intensive farming must involve supplementary feeding. Some farms claim to rely on fertilisation, rather than feeding, at the beginning of the rearing period. Some stimulate an initial algal bloom through the addition of an inorganic fertilizer (such as a liquid 0-36-0 formulation, applied to provide about 9 kg/ha of phosphorus). Others find that providing feed from the beginning of the rearing period improves performance and is cost-effective. However, the dividing line between the effectiveness of feed as a direct nutritional input to the prawns and what is acting as a fertilizer is blurred. Whether the feeds are pelleted mixtures or individual ingredients (such as distillery or brewery by-products), they actually act as both feeds and fertilizers. At the beginning their primary use may be as an organic fertilizer that enhances the availability of natural feeds in the rearing ponds. Later, as the prawns grow, the feeds become more and more directly consumed by the prawns. The application of feeds/fertilizers from the beginning of the rearing period not

**Figure 74**  
*Macrobrachium rosenbergii* farming can be integrated with crop and other livestock production; in this case prawn culture is associated with rice culture and vegetable production (Viet Nam)



**SOURCE:** MARCY WILDER, REPRODUCED FROM NEW AND VALENTI (2000) WITH PERMISSION FROM BLACKWELL SCIENCE



only increases the availability of natural food but also decreases the transparency of the water, therefore reducing the growth of weeds.

The types of feed used in freshwater prawn farming vary widely and include individual animal or vegetable raw materials and feed mixtures prepared at the pond bank; both of these are generally referred to as 'farm-made feeds'. In addition, commercial feeds designed for freshwater prawns are available in some countries, sometimes from several aquafeed manufacturers. Freshwater prawns are omnivores and, so far as is known at present, their nutritional requirements are not very demanding. Some farmers utilize commercial feeds designed for marine shrimp in freshwater prawn nurseries or during the first

## Examples of integrated freshwater prawn culture in Viet Nam

BOX 22

### Example 1:

In Viet Nam, most PL and juveniles for stocking grow-out areas still come from the capture fisheries, where brushwood (Figure 75), stow and straw nets, and shelter traps are commonly used, although hatcheries are beginning to be established. Ponds and garden (crop production) canals are typically stocked at 4-6 juveniles/m<sup>2</sup> and paddy fields at 0.5-2/m<sup>2</sup>. The ponds are usually rectangular and small (0.1-0.2 ha), while the rice fields are 0.5-2.0 ha, of which 15 to 20% of the space consists of internal canals. In the paddies, the water level is 1.0-1.2 m in the canals and 0.2-0.6 m over the rice growing area (when flooded). Both farm-made and commercial feeds are used in the ponds and, intermittently, in the rice fields. Ponds have about 2-4 months downtime between crops, during which liming and predator eradication is practised. Urea (CH<sub>4</sub>N<sub>2</sub>O) and diammonium phosphate [(NH<sub>4</sub>)<sub>2</sub>HPO<sub>4</sub>] are used in the rice fields.

Monocultured pond productivity ranges from 0.60-0.75 mt/ha. In polyculture, total aquaculture production is 2.1-3.0 mt/ha, of which about 10% is freshwater prawns, the rest being finfish: silver carp, silver barb, tilapia, river catfish, and common carp. The prawn productivity in rice fields is about 0.1-0.3 mt/ha/yr. It is normal for there to be two rice crops per year but the prawn crop spans both of them; the prawns remain in the irrigation ditches (or are temporarily transferred to an adjacent pond) during the first rice harvest and are allowed back into the paddies for a total of 8-12 months rearing period. Selective harvesting occurs several times before the final drain harvest.

### Example 2:

In areas of Viet Nam where only one rice crop is possible because the salinity of rivers and canals is too high for growing rice during the dry season, the addition of *M. rosenbergii* to an integrated system may

be beneficial. Experiments in crustacean-crop integration were conducted in three fields (0.4, 0.5, and 0.6 ha). Rice was planted in mid-June, freshwater prawns were stocked (1.5/m<sup>2</sup>) at the end of June, the rice was harvested in mid-November, and freshwater prawns were harvested in early February. In one field, marine shrimp (*Penaeus monodon*) were also stocked (1.5/m<sup>2</sup>) in mid-February and harvested in early June (just before the rice planting of the second year). The farmed crustaceans used natural food until the final month of culture, when supplemental food was supplied. Yields ranged from 2.9 to 3.4 mt of rice and 434 to 596 kg/ha of freshwater prawns (average individual weights ranged from 62 to 76 g). In the one field where tiger shrimp were stocked, an additional 390 kg/ha of shrimp was harvested (mean weight 42g). The researchers concerned stated that this form of farming was a low-investment, high-revenue, no-pollution opportunity.

SOURCE: NEW (2000b) AND ZIMMERMANN AND NEW (2000)

**Figure 75**  
If hatchery-reared *Macrobrachium rosenbergii* are not available, brushwood can be used to capture wild postlarvae (Viet Nam)



**SOURCE:** MICHAEL NEW, REPRODUCED FROM NEW AND VALENTI (2000) WITH PERMISSION FROM BLACKWELL SCIENCE

can assess the relative suitability of commercially available feeds by asking your local extension agent from your government fisheries department and checking with other freshwater prawn farmers.

Commercial feeds may be the most productive and reliable to use but they are expensive, are not always available to the small farmer, and do not take advantage of locally available ingredients. You may also have problems in storing compound feedstuffs in humid conditions where deliveries cannot be made regularly in small quantities. If you make your own feeds, some of your ingredients can be locally available. You can also produce them with your own farm labour and simple equipment, such as small bakery mixers and meat mincers. Usually, no extra labour is required. Feed making just forms another job which can be fitted in between the other duties of your farm labourers.

Many different ingredients could be used in your farm-made feeds, either individually or combined into 'compound feeds'. Commercial feeds for freshwater prawns tend to use ingredients which are available in large quantities; many of them are global commodities, such as fish meal or soybean meal. You can also include some of these ingredients in the feeds you make on-farm, as shown in the formulae given in this manual. In addition, you could include so-called 'unconventional feeds' (feeds not normally used in commercial feeds because they are only available in small quantities, often only locally and seasonally); some of these are listed in Table 18. In addition to 'trash' fish, molluscs and prawn wastes form valuable animal protein sources. Meal made from the leaves of the Ipil ipil bush (*Leucaena* sp.) has formed a constituent of shrimp and prawn diets but its use is cautioned by the toxicity of mimosine, which is a problem in its use for terrestrial animals. Some farmers add other materials to their ponds, including pig manure (added as a feed, not a fertilizer, where ethnically acceptable) and the mortalities from chicken farms, staked out around the periphery of the pond. Other locally available materials may also be satisfactory.

If you use individual raw materials (not made into a mixed and bound compound feed), especially wet materials (such as trash fish and beef liver), you stand more risk of causing your pond water to become polluted. Compounded feeds, especially when they are water-stable, cause less problems of this type. Compounded chicken and pig feeds, either unmodified, or re-extruded through a mincer with trash fish or prawn meal, have been used in freshwater prawn farming. Some are included in the formulae given in this manual. However, be careful about using chicken and pig feeds because they often contain growth promoters, antibiotics, and other substances which may have unpredictable effects on prawns. Their presence in prawn tissues may also make the product unacceptable.

few weeks of the grow-out phase when prawns are stocked as PL. Marine shrimp feeds have a much higher protein content than is needed for freshwater prawns, so cheaper commercial feeds that have either been specifically designed for freshwater prawns or for a species of fish (e.g. catfish) must be used in grow-out ponds stocked with nursery-reared juveniles, or substituted as soon as possible in those stocked with PL. You

Using water-stable feeds provides your prawns with a balanced ration. It also stops the prawns selecting individual ingredients. Using well-bound compounded feeds also results in less water pollution and makes your task of judging how much feed to give each day easier. Feeds can be made water-stable by including a wide range of naturally occurring and modified gums and binders, by adding pre-gelatinized starch, and by certain processing techniques used by feed manufacturers. Some typical formulae for freshwater prawn diets are given in Annex 9.

The methods for making farm-made feeds are not described in this manual because there are other publications available. Details are provided in another FAO manual (New 1987) and the use of farm-made aquafeeds generally is discussed in New, Tacon and Csavas (1995). If you are formulating your own diet it is necessary to determine [by analysis and/or

TABLE **18** Examples of major ingredients either used individually or in mixed freshwater prawn grow-out feeds

PLANT INGREDIENTS	ANIMAL INGREDIENTS	INGREDIENTS TO BE USED WITH CAUTION <sup>10</sup>
Soybean meal	Fish meal	Shrimp processing wastes
Cottonseed meal	Shrimp shell meal	Prawn processing wastes
Groundnut meal	Mollusc flesh	Meat and bone meal
Coconut oil cake	Marine shrimp meal	Compounded chicken feeds
Sesame cake	Trash fish	Compounded piglet feeds and concentrates
Moist pressed brewers' grains	Squid meal	Ipil ipil ( <i>Leucaena</i> sp.) meal
Brewers yeast	Meat meal	
Dry sugar cane yeast	Beef liver	
Distillers' dried grains	Silkworm pupae	
Broken rice	Silkworm litter	
Rice bran	Earthworms	
Corn (maize) meal		
Corn silage		
Wheat meal		
Wheat bran		
Wheat middlings		
Cassava/tapioca		
Fresh leaves		
Alfalfa		
Grass meal		
Orange flesh		
Peeled sweet potatoes		
Frozen peeled bananas		
Butternut squash		
Yellow squash		
Turnip greens		
Carrot tops		

<sup>10</sup> Shrimp and prawn processing wastes (heads, shells, etc), sometimes used in farm-made feeds, may be virus disease carriers, if used raw (not processed). It is better to use commercially available shrimp meals. The diseases they carry may not produce obvious symptoms in freshwater prawns but could induce them to transfer the disease to other crustaceans. Meat and bone meal is a banned feedstuff ingredient in some countries (because of BSE); prawns reared on aquafeeds containing meat and bone may face consumer resistance. Compound feeds made for other species may contain antibiotics and/or levels of other substances harmful to prawns. Ipil ipil contains the toxin mimosine. Some other high-protein plant ingredients also contain toxins but these are removed by adequate processing.

TABLE 19 Tentative specifications for semi-intensive freshwater prawn grow-out feeds

NUTRIENT	AMOUNT	NOTES
<b>Lipid (%)</b>	5	no fixed requirement; this is a suggested level
<b>Higher unsaturated fatty acids (HUFA), namely 22:6 n-3 and 20:4 n-6 (%)</b>	>0.08	
<b>n-3/n-6 fatty acid ratio</b>		has yet to be demonstrated to be important
<b>Total cholesterol (%)</b>	0.6	
<b>Phospholipids</b>		sufficient phospholipids may be contained in normal ingredients for use in feeds for prawns reared in nursery and grow-out ponds but the addition of 0.50-0.75% supplementary phosphatidylcholine (PC) in the form of soy lecithin is suggested to obtain maximum growth for juveniles held in nursery tanks
<b>Protein (%)</b>	35 30	level suggested for the first 2 months after PL are stocked, whether grown in nurseries or placed directly into grow-out ponds level suggested from month 3 to harvest
<b>Carbohydrate</b>		no fixed requirement
<b>Calcium (% Ca)</b>	2-3	depends on local water hardness; the 2% dietary level assumes that the calcium level of the rearing water is about 75 mg/L (CaCO <sub>3</sub> ) and the 3% dietary level assumes a calcium level in the water of about 50 mg/L (CaCO <sub>3</sub> ); feeds for use in rearing in harder water should have a lower calcium content and <i>vice versa</i>
<b>Available phosphorus</b>		minimum quantitative requirement for freshwater prawns not yet known, but the calcium/phosphorus ratio given below should ensure that the available phosphorus content is similar to that found essential for various fish species
<b>Calcium/phosphorus ratio (Ca:P)</b>	1.5-2.0:1	suggested ratio
<b>Vitamin C (mg/kg)</b>	100	
<b>Other vitamins</b>		quantitative requirements not yet known; a supplementary vitamin mix may not be necessary for feeds used for semi-intensive grow-out
<b>Zinc (mg/kg)</b>	90	
<b>Other minerals</b>		quantitative requirements not yet known; supplementary mineral mix may not be necessary for feeds used for semi-intensive grow-out

consulting published information (Fonnesbeck, Harris and Kearl 1977; Gohl 1981; New 1987; Tacon 1987, 1993a, 1993b)] the composition of your locally available ingredients. Some specifications for freshwater prawn grow-out feeds are given in Table 19. Recently (Anonymous 2001a), it was reported that a farm-made aquafeed and feed mill unit has been launched in Cochin, India. Here, farmers can manufacture their own feed using communal equipment. This kind of development was recommended in a meeting in Thailand in 1992 (New, Tacon and Csavas 1995) and it is hoped that more units like this will emerge to assist small farmers to make their own, cheaper feeds. However, if you choose not to make your own feeds, consult your local aquafeed manufacturers and ask if they make feeds for freshwater prawns. You will find that they are keen to help you.

## MEASURING FEED EFFICIENCY

You should not judge the value of a feed only by its unit cost (price per mt of feed). What you must consider is:

- what weight of prawns you will get by using this feed (mt/ha/crop) ?
- what proportion of the prawns produced will be marketable (the correct size for your market; good appearance, etc.) ?
- what will your total feeding costs be (this includes not only the cost of the feed itself, but how much does it cost you to store it, transport it to the ponds, feed it, and solve any problems it may cause in pond management) ?

The unit of measurement most commonly used on the farm is the feed conversion ratio (FCR). This is the actual weight of feed presented divided by the actual weight of animals produced (no adjustments are made for the differing moisture contents of the feed and the prawns). An FCR of 2:1 to 3:1 would be typical for a dry (~10-12% moisture) compounded diet. The FCR of wet feeds, such as trash fish, is much higher, perhaps 7:1 to 9:1. A semi-moist feed (typically with a moisture content of 35-40%), consisting of a mixture of dry and wet ingredients, might have an FCR of 4:1 to 5:1.

However, FCR is a rather crude measurement, because it only refers to total productivity. This is not the whole story. Time from stocking to harvest (the growth rate achieved), the prawn size and quality obtained, and the cost of storage and feeding are just three of the other factors that are important. For example, suppose that two feeds have an equal unit cost and the same FCR, the use of one may result in prawns reaching the average marketable size in 5 months, the other may take 6 months. The first is obviously the more efficient. FCR alone does not tell you this. This illustration is provided simply to make you think about your choice of feed more carefully.

## FEEDING RATE

There can be no exact general recommendation for daily feeding rates, because these depend on the size and number of prawns (and, in a polyculture system, fish) in the pond, the water quality, and the nature of the feed. Some farmers start feeding rates very high at first (perhaps as much as 100% of body weight at the PL stage). If juveniles are stocked, the rate might be 20-10% of body weight (depending on juvenile size) and it would decline gradually to about 2% by harvest time. This works quite well if the ponds are batch-harvested. However, if you are culling out the larger animals, this may result in some under-feeding for the others. It is also very difficult to calculate even a reasonably accurate estimate of the total body weight in your pond.

This manual recommends that you should start by feeding a fixed amount, which depends on the pond size, to encourage the growth of natural food (as measured by transparency, see below). Then, you should continue by feeding 'to demand' (in other words, giving as much feed as the prawns will eat but no more). Spread the feed around the periphery of the pond in the shallows, which are good feeding zones. Putting the feed in defined 'feeding areas' a few metres apart makes it easier to observe how much is consumed. This practice also leaves the areas in between the feeding zones clean, thus lessening pollution and promoting more healthy rearing conditions. Some farmers operating large ponds use boats to distribute feeds more evenly (Figure 76). Others use rafts, which are towed around fixed routes by means of a series of ropes guided by fixed wood or bamboo stakes within the pond or on its banks, for this purpose. Whether you confine feed to the periphery of your pond or distribute it more widely throughout your pond, the use of defined feeding areas, rather than general broadcasting, is recommended.

**Figure 76**

Feed can be distributed within the pond by simple boats, which can be lifted from one pond to another; manual feeding along at least one side of the pond would be quite difficult in this case because of the method of construction, which has set a water channel in a very narrow pond bank (Thailand)



**SOURCE:** HASSANAI KONGKEO

The best way of measuring food consumption is to use feeding trays (Figure 77), which can be lifted out of the water for inspection. You can construct lift nets from any netting with a mesh small enough to retain the feed particles. If you use this system, lift the tray out of the water for inspection to see how much feed has been consumed before you distribute the next feed. If there is no feed left on the following day, the feeding rate should be increased. If there is excessive food left, the feeding rate should be decreased. In cases of severe over-feeding, which may cause water quality problems, feed may even be omitted

for a day. The need for the operator to be able to see the unused feed after 24 hours highlights one of the advantages of a water stable diet.

Where you have enough water available to allow it to flow through the pond all the time, you could adjust the phytoplankton density by altering the water flow rate. Even if your pond is normally static you could flush the pond if the phytoplankton density becomes too high (or there are other reasons to suspect poor water quality) by partially draining and refilling the pond. However, the best means of controlling phytoplankton density without wasting water (and money!) is to carefully monitor the effect of feeding rate and aeration (which is often used in nursery ponds and always in intensive grow-out) on water transparency, and make alterations as necessary. By this means panic situations caused by gross over-feeding can be avoided.

Exact daily feeding rates are site and management specific. However, an example is given in Box 23, which also describes how to adjust feeding according to water transparency. This example

**Figure 77**  
Using a lift net for observing feed consumption (Puerto Rico)



**SOURCE:** HAROLD PHILLIPS

## Example of feeding rate for freshwater prawns

### ASSUMPTIONS:

- ⊙ Monoculture
- ⊙ Location is a tropical zone with an optimum water temperature
- ⊙ Stocking rate 5 PL/m<sup>2</sup>
- ⊙ Expected yield 1 250 kg/ha in 6-8 months
- ⊙ A dry diet is fed

### FEEDING REGIME:

- ⊙ **BEGIN** by feeding about 6 kg/ha/day. This is far more than the prawns will consume when they are young PL but the diet also acts as a fertilizer for enhancing the natural food available. This will increase the availability of benthic fauna and will build up the plankton density to a level which will provide cover for the prawns and prevent the growth of rooted aquatic plants.
- ⊙ **CHECK** the transparency (governed by the amount of phytoplankton present) of the pond water regularly with a Secchi disc (Figure 78).
- ⊙ **CONTINUE** feeding about 6 kg/ha/day until the Secchi disk reading shows that a visibility of between 25 and 40 cm has been reached. A cruder method of making this measurement is to immerse your arm in the water up to your elbow. If you can easily see the tips your fingers the water is too clear. If you cannot see your wrist then the phytoplankton density is too high.
- ⊙ **WHEN YOUR MEASUREMENTS SHOW** that the phytoplankton density has reached the desired level, start to adjust the amount of feed you give by examining the daily consumption of the prawns, preferably by inspecting your lift nets. This is called demand feeding.
- ⊙ **YOU ARE RECOMMENDED** to put all the daily feed ration into the pond once per day in the late afternoon [however, many farmers prefer to split the daily ration into two feedings. If you do this, give 30% in the early morning and 70% in the late afternoon].
- ⊙ **YOU WILL FIND** that the daily amount of feed, judged by consumption, will begin to rise gradually from the initial 6 kg/ha/day. By harvest time it will be much higher. The exact peak in feeding level will depend on the growth and survival rate of the prawns. You can expect the feeding rate to build up to nearly 40 kg/ha/day at the time just before a pond is harvested.
- ⊙ **IF YOUR FEEDING** adjustments have been accurate, and if the prawns have grown and survived normally, you should find that your total use of feed should not exceed about 3 000 kg (assumes an FCR of about 2.4) for each rearing cycle.

assumes that PL are stocked directly into the final grow-out pond. The use of feedstuffs to induce phytoplankton growth may seem rather expensive (compared to using fertilizers) but it is simple and effective. However, rearing PL to juvenile size in a nursery system, as described earlier in this manual, is a more efficient way of using feeds for the first 2 months or so after metamorphosis.

## 6.4 Health, predation and disease

### WATCHING FOR SIGNS OF PROBLEMS

Continuous exchange of a small proportion of the water is the normal way of maintaining good water quality. However, some farmers change water more suddenly every two weeks,

**Figure 78**  
Measuring transparency can be very simple, even when the design of the Secchi disk is unconventional (Peru)



SOURCE: OSCAR ORBEGOSO MONTALVA

and in much larger proportions, because this tends to make the prawns moult. The more that moult (and are therefore soft-shelled) at the same time, the less potential losses there may be due to cannibalism. A scum of phytoplankton may cover the surface of the pond. This will cause low DO<sub>2</sub> problems at night and should be controlled by a reduction in feeding and by exchanging water. Low DO<sub>2</sub> should be suspected if prawns begin to crawl out of the ponds or congregate at the edges of the pond in daylight. If this problem occurs, flush the pond. The need to do this in emergency situations illustrates the importance of having sufficient water available. Very high pH levels in freshwater prawn ponds can cause prawn mortalities, both because of the direct effect of the pH itself and because of the greater solubility of waste ammonia at high pH. High pH is often caused by dense phytoplankton blooms.

If you see sudden heavy mortalities, or observe small numbers of mortalities over a period of time, you should carefully investigate the cause. Prawns covered with algae or showing signs of not having moulted recently may indicate either that culture conditions are poor or that the animals are not healthy. Poor farm management, resulting in poor water quality and/or disease may be to blame. However, external factors may also be responsible. The most likely source of external water pollution is from pesticides and herbicides. For example, pesticides used on neighbouring banana farms and herbicides used for the elimination of water hyacinths in irrigation canals have been blamed for prawn mortalities in the Caribbean and Thailand respectively. Thus the importance of site selection and water source is obvious. Further reading on this topic is contained in Boyd and Zimmermann (2000), Correia, Suwannatous and New (2000) and Daniels, Cavalli and Smullen (2000).

## DEALING WITH PROBLEMS OF PREDATION

Predation is one of the greatest problems for any aquaculture enterprise, including freshwater prawn farming. Predation is caused mainly by other aquatic species, birds, snakes and humans. Two of the greatest sources of loss in freshwater prawn farming are human predation and operator error.

Freshwater prawn farms are more prone to human predation than many fish farms because of the high value of the product and because prawns are relatively easy to catch. The temptation to catch a few kilograms of prawns by cast-net at night (a kilogram of which may be as valuable as a tenth of a month's individual income to some) is sometimes too great to resist. You cannot eliminate any form of predation, including human poaching. However, you must minimize it by good management. Perimeter fences, dogs, lighting, and reliable watchmen help. If your farm is big enough to financially support it, you may be able to achieve some protection from human predation if you stock some PL into local public waters, thus generating a positive attitude towards your farm. If you own a small farm you may find it useful to form a cooperative with other farmers within the community. The activities of such groups are normally protected by the local community. You may also lose prawns through operator error and poor management. For example, water levels may be



allowed to become too low and therefore temperatures too high, or DO<sub>2</sub> levels may be allowed to fall too low. Both errors will cause animals to die. Not maintaining outlet structures properly allows prawns to escape.

Normally, insects (mainly dragonfly nymphs), carnivorous fish and birds are the most serious predators in freshwater prawn farming. In the past, chemicals have been used to kill dragonflies and other insects but this is not recommended because it may negatively affect the pond ecosystem. Mosquito fish (*Gambusia affinis*) and related species were also once stocked in freshwater prawn ponds to control insects. *M. rosenbergii* post-larvae themselves, if they are stocked before the insects hatch, can control the dragonfly population. You can effectively control unwanted fish by using rotenone or teaseed cake between cycles, as discussed earlier in this manual. You can prevent the entry of fish and some insects by passing the intake water through suitable screens or gravel filters (Figure 79). Most commercial prawn farms rely on simple net filters. If fish eggs and larvae do get into your ponds (which they will!), it is not a complete disaster because, by the time they get to a dangerous size, many will be seined out during the cull-harvesting of prawns. The ideal would be to exclude all predators but this is not possible. The most important thing is to stock the prawns very soon after each pond is filled, so that predators and competitors have less chance to become established. The presence of many frogs and toads in a pond usually indicates that predatory fish have been fairly efficiently excluded.

It is suggested that you use small 60 cm high netting fences around ponds for the prevention of invading catfish and snakehead fish (Figure 80). These fences may also prevent the entrance of amphibians, reptiles and some mammals. You will also find that the seining that you do during the cull-harvesting of prawns can remove large predators, such as fish, turtles and snakes. Birds are very difficult to repel or control. Netting or string can be stretched across the top of ponds as a deterrent. You can use various bird-scaring devices. In general, you should not shoot invading birds because you may be breaking local bird conservation regulations [a list of endangered birds is available in the IUCN Red List (IUCN 1996)]. The use of dogs as bird scarers may be more efficient and cheaper than shooting them.

Competent management of prawn competitors and predators includes stocking prawns as soon as the pond is filled, seining periodically, and totally draining and treating the ponds at least once per year.

## COPING WITH DISEASES AND OTHER PROBLEMS

Diseases in freshwater prawn ponds are relatively unusual, compared to other forms of aquaculture. However, this may be a function of the relatively low stocking densities used

**Figure 79**  
A simple gravel filter on a farm supply system helps to exclude predators (Brazil)



**Figure 80**  
Netting can be used to protect freshwater prawns from predators that arrive overland (Brazil)



SOURCE: WAGNER VALENTI

SOURCE: JULIO VICENTE LOMBARDI

so far. If stocking rates are increased, more problems may occur in future. Furthermore, diseases have been known to occur in freshwater prawn grow-out when the quality of the water (either of the intake or within the pond itself) is poor. Proper attention to the possibility of disease and other problems is therefore essential. The potential problems are discussed in this section of the manual.

The general issues of health, defence mechanisms against disease, and diagnosis have been dealt with by Johnson and Bueno (2000); their review also contains general information on sanitation, quarantine and therapeutic treatment. There are number of other problems in freshwater prawn grow-out, which include the result of nutritional deficiencies, fouling or parasites.

### Diseases of known cause

A summary of the infectious diseases currently known to affect freshwater prawns during the grow-out phase is given in Table 10, while Table 11 lists some actions that can be taken to reduce the incidence of these problems (prevention). Some treatments that have been used, often experimentally, after the appearance of diseases are also listed in Table 11. However, treatment is not normally practical. The continuous use of antibiotics and other chemicals is also not recommended, either in hatcheries or grow-out systems. It is not thought practical to treat prawns in commercial grow-out facilities at this moment (practical and environmentally acceptable treatments may evolve in the future).

Prevention (through good management) is always better than attempted cure. There are potential human health hazards and food safety issues concerning the use of antibiotics. Some, such as chloramphenicol, are banned substances in aquaculture. If you do use antibiotics, you must consult your local aquatic animal health specialist and only use approved substances in the correct dosages. You must also follow the specialist's advice on how long before harvest to stop using the product, to make sure that there are no residues in your harvested prawns.

Disease problems may originate during the transfer of animals from one site to another, including the introduction of animals into a location where they are not indigenous. Comments on the care which should be taken with introductions have already been mentioned in this manual.

### Diseases of non-specific cause

All life stages of freshwater prawns are also subject to a disease known as muscle necrosis. Affected prawns show a whitish colour in the striated muscle of the tail and appendages. The necrotic areas may increase in size and become reddish, a colour similar to cooked prawns, due to the decomposition of the muscle tissue. Secondary pathogens (bacteria and the fungus *Fusarium*) have been found to be associated with muscle necrosis (see Table 10). Prawns suffering from chronic muscle necrosis do not survive. Population mortality rates vary from insignificant to 100%. This disease is associated with poor management and occurs particularly when stocking rates and handling stress are high and when environmental conditions are poor (low dissolved oxygen level; temperature fluctuations; and, in the hatchery, salinity fluctuations). Follow the good management practices suggested in this manual and you will minimize the occurrence of such problems.

Other diseases of uncertain origin affect freshwater prawn larvae; these have been described earlier in this manual.

### Parasites

Parasites seem to be quite rare in cultured *M. rosenbergii*. Freshwater prawns have been

found to be hosts for the bopyrid isopod *Probopyrus*. These attach themselves to the interior of the gill chamber, usually resulting in a visible swelling. This would normally only be a problem if it became common in a captive broodstock, because it is reported to interfere with egg production. The only other problem that might occur if this parasite became common in grow-out would be its affect on the appearance of prawns sold head-on; so far this has not been described.

Wild-caught freshwater prawns of various species have been observed to be intermediate hosts for trematode worms. Prawns have also hosted the Asian lung fluke but are thought to have an unimportant role in its transmission to mammals.

### Fouling

The general body surface of the prawn can serve as a substrate for filamentous bacteria and algae, and single or colonial protozoa. More information about the specific organisms that cause fouling (which include *Zoothamnium*, *Epistylis*, *Vorticella*, *Leucothrix* and many others) and references to further reading on this topic are given in Johnson and Bueno (2000). Moulting temporarily frees prawns from these fouling micro-organisms. The problem is particularly noticeable in large animals, especially blue-claw (BC) males, which moult less often.

Although these organisms do not invade the tissues they make it difficult for the prawns to move and to feed, particularly in the larval and postlarval phases. Extreme infestation on the gills can impair their function, and may cause mortalities in juvenile or adult prawns. Heavy infestation over the exterior surface can also reduce the market value of prawns. Infestation by filamentous algae has been observed to occur in grow-out ponds with high transparency (above 40 cm). This problem can be therefore be reduced by encouraging lower water transparency through feed management.

You can cut down the incidence of problems in hatcheries caused by fouling organisms by good management, especially the correct treatment of incoming water, the proper cleaning of tank bottoms, and the treatment of *Artemia* cysts. In both hatcheries and ponds the avoidance of over-feeding and increased water exchange help to minimize the fouling of animals. A number of chemical treatments against fouling organisms have been suggested (Johnson and Bueno 2000) but are not recommended in this manual.

## 6.5 Monitoring performance and record keeping

---

The growth rate and survival of each population of prawns depends on many factors, including density, predation, feed and temperature. Since these factors are so site- and operator-specific it is not wise to predict what they will be in this manual, for fear of causing expectations which may not be realized. However, Box 24 gives examples of growth and production rates that have been reported in the scientific literature. Survival rates during the grow-out period should not fall below 50%. Under the semi-intensive management system described in this manual, productivity ranges of 1 000-3 000 kg/ha/yr are typical but can be exceeded.

As your farm operates, you will develop your own experience of growth rate and productivity during grow-out. You can only achieve this by careful monitoring and record keeping. It cannot be over-stressed that you should keep adequate written records of such things as water quality, stocking rate and date, daily feeding quantities, dates on which water changes are made (and how much), harvesting dates and quantities, etc. Only in this way can you build up a picture of how each pond behaves under a certain management regime (and every pond is different) and accurately apply your experience to future pond

## Examples of freshwater prawn (*M. rosenbergii*) growth and production rates

### AVERAGE YIELD:

The following yields are on an annual basis, except where indicated.

**TROPICAL MONOCULTURE:** 800-1 200 kg/ha (Brazil); 1 500 kg/ha (Dominican Republic); 1 200-2 500 kg/ha (Guadeloupe); 2 000-2 250 kg/ha/6-7 month crop (India); 900-3 150 kg/ha/crop (Malaysia), 520-1 926 kg/ha (Martinique); 1 286 kg/ha (Polynesia); 909-1 909 kg/ha (Puerto Rico); 2 000 kg/ha (Taiwan Province of China); 1 500 kg/ha (Thailand); 3 100 kg/ha/crop (Thailand, with paddlewheel aeration); 600-750 kg/ha (Viet Nam).

**TROPICAL POLYCULTURE AND INTEGRATION:** 200-300 kg/ha (Bangladesh); 200-500 kg/ha (India); 200-300 kg/ha (Viet Nam).

**TROPICAL INTEGRATED CULTURE:** 100-300 kg/ha (Viet Nam, in ricefields).

**TEMPERATE CULTURE:** [The growing season is typically 4.0-5.5 months per year] 2 250-3 000 kg/ha/crop (China, in monoculture); 1 200-1 800 kg/ha/crop (China, in polyculture with carps when the emphasis is on prawn production); 300-900 kg/ha/crop (China, in polyculture with carps when the emphasis is on fish production); 1 200 kg/ha/crop (USA, in commercial monoculture); ~3 000 kg/ha/crop (USA, in experimental monoculture with substrates).

### MONOCULTURE IN GEOTHERMALLY HEATED WATER:

2 500-3 000 kg/ha (New Zealand).

### GROWTH RATES:

The following are very approximate data from experimental work - exact rates depend on environmental conditions and, in the case of grow-out, on the way in which size variation is managed; intermediate cull-harvesting will pull out marketable animals which grow at a much faster rate than the average.

**PL AND JUVENILES** with starting weights of between 0.01 and 0.3 g can grow between 5 and 30 mg/day over periods of between 60-75 days in indoor and outdoor nursery facilities.

**0.25 g JUVENILES** reached an average of nearly 34 g in ~132 days when stocked in temperate zone ponds at ~4/m<sup>2</sup> or about 26 g when stocked at ~8/m<sup>2</sup>.

**0.33 G JUVENILES**, stocked at about 6/m<sup>2</sup> in another temperate zone experiment, reached an average of 30 g in 106 days in ponds without substrates and nearly 37 g in ponds provided with substrates.

Recently, the production of prawns averaging 52 g in temperate zone ponds with substrates has been reported but details of stocking rates, size of juveniles stocked or time of rearing have not yet been published.

**SOURCE:** ALSTON AND SAMPAIO (2000); DANIELS, D'ABRAMO, FONDREN AND DURANT (1995); NEW (1995; 2000b); REDDY & RAO (2001); J. TIDWELL (PERS. COMM. 2001); TIDWELL, COYLE AND SCHULMEISTER (1998).

management in order to operate your farm profitably. This applies equally to hatchery management.

Methods of monitoring feeding rate and phytoplankton density and for the control of the latter have been dealt with earlier in this manual. It is good practice, if possible, to monitor other water quality parameters such as pH, temperature and dissolved oxygen routinely, so that you can link production rates with the environment of each pond and the way in which you manage it. This will give you the information you need to take actions to prevent a recurrence of problems (such as low dissolved oxygen levels, for example).

**Figure 81**  
A large BC *Macrobrachium rosenbergii* broodstock male from the CAUNESP (Aquaculture Center, São Paulo State University, Brazil) being measured in the 'scientific' way (from behind the eye orbit to the tip of the telson)

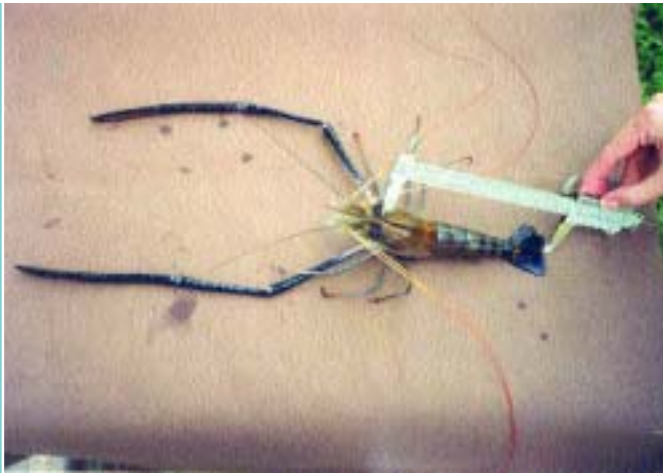

SOURCE: DEBORAH ISMAEL

way known of determining the standing crop of freshwater prawns in a pond unless the pond is regularly seined. Even when a reasonable estimate of pond biomass can be obtained, daily feeding rates based on a percentage of biomass should not be applied blindly but should be tempered by observations on consumption and phytoplankton density.

Ideally, you would like to determine the average size and the number of prawns in your pond at any time. In this way you could tell whether growth and survival rates are satisfactory, or not, and determine a daily feeding rate based on a percentage of the pond biomass. Unfortunately, there is no accurate

## FIGURE 82

There is a relationship between the total length and the weight of your prawns; this shows a typical length/weight relationship for *Macrobrachium rosenbergii*

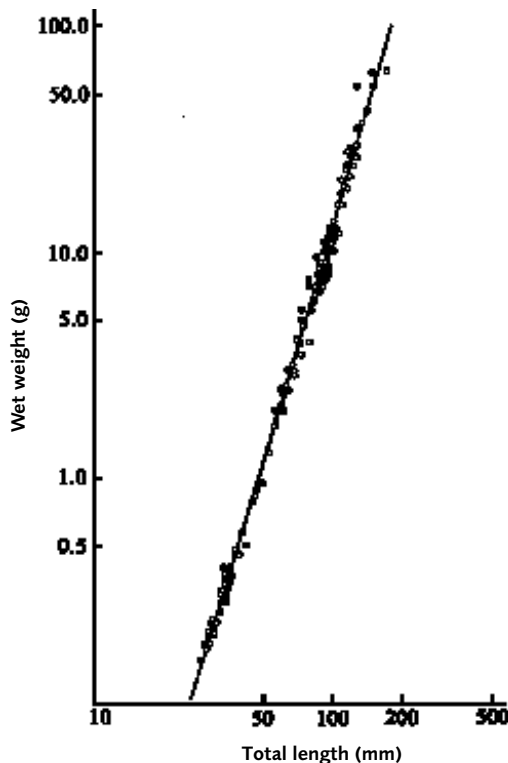

SOURCE: WICKINS (1972)

If you are growing freshwater prawns for the first time, you must realize that individual prawns within a population grow at different rates. Some will grow very fast, others hardly at all. This normal characteristic of the animal has been described in Annex 8. The disparity in growth rate is more pronounced among males than females and in mature populations of freshwater prawns.

You should regularly measure growth rate, either by weight or total length. Measurement of length from the eye orbit to the tip of the telson (Figure 81) is the most reliable technique (because the rostrum of some animals becomes shortened by damage) but, in farming practice, total length from the tip of the rostrum to the tip of the telson is usually measured, often by ruler. Figure 82 gives the relationship between total length and live weight for a mixed-sex population of freshwater prawns. Males weigh slightly more than females of the same length, but not markedly so. A

method for sexing small (juvenile) prawns is shown in Figure 3. The differences between larger females and the various male morphotypes have also been described earlier in this manual.

If you have never grown freshwater prawns before you may notice that you do not see the prawns after they are stocked; they are difficult to see and to catch at this stage. Do not be discouraged! At this time, you will be giving quite large quantities of food but, after a while, you may begin to think that the feed (and your money!) is being wasted. You cannot see many prawns, so you wonder: have they all died, escaped, or been eaten by predators? Do not decrease the amount of feed or stop feeding altogether. About two months after stocking, you will begin to see (by now quite large) prawns again. If you wait until the stage when you can see the prawns in the pond to start feeding again, the productivity of your crop will have been permanently reduced. This is a common experience of new farmers of this species. Have patience, and examine the perimeter of your ponds by night, with the aid of a flashlight.



# Harvesting and post-harvest handling

## 7.1 Harvesting your market-sized prawns

Basically there are two methods of harvesting: culling (sometimes called cull-harvesting) and draining (drain-harvesting). The time to harvest depends partly on growth rate and the size of animals you want to sell. This, in turn, depends on your market requirements. It also depends on the pond management technique chosen. Cull-harvesting is used to harvest market-sized animals from the pond at intervals and removes the faster growing prawns. Annex 8 gives further information on size management. The rest of the prawns are caught when the ponds are drained at the end of the grow-out cycle.

In tropical ponds cull-harvesting usually starts 5-7 months after PL have been stocked, or sooner if juveniles have been stocked. After cull-harvesting commences, you should totally seine each pond once per month or partially seine it twice per month (i.e. seine half the pond twice per month or all of it once per month). Take out the market-sized animals and sell them. Keep the smaller ones and soft-shelled animals in the pond for further growth. After about 8-11 months, drain the pond and sell the whole harvest. In areas where water supply is short, some farmers utilize water drained during complete harvesting in other ponds to conserve water but, if you think of doing this, beware that you may be transferring a water quality or disease problem from one crop to the next. This practice is not recommended in this manual. After drain-harvesting, you can either prepare, refill and restock the pond immediately, or keep it empty until you have enough water available again and/or (in temperate zones) until water temperatures become suitable again for rearing.

Cull-harvesting is not very efficient in removing harvest-sized prawns. It does not maximize the total quantity of marketable prawns which could be achieved, partly because some marketable animals remain in the pond longer than necessary and partly because the smaller prawns do not get the maximum chance to grow faster than they would have if there were no dominant prawns left behind. In theory, the best management system would

be to totally harvest the pond, remove all the dominant animals, and restock the others in the same or a different pond. Various management strategies to maximize pond utilisation and production rate have been described, for example the modified batch system developed in Puerto Rico, as mentioned earlier. A four-pond multi-stage rotational scheme, which includes the re-stocking of undersized prawns following harvest, is described by Karplus, Malecha and Sagi (2000). Some handling losses occur during the animal transfers necessary for these more complex management systems. These types of management may be feasible in large farms with many available ponds. However, cull-harvesting, followed by total drain-harvesting before re-stocking with a new batch, remains the most practical management scheme for small freshwater prawn farms.

You should carry out all harvesting operations as early as possible in the morning when it is cooler, to avoid having water levels too low when the sun is directly overhead. If you allow the water to become shallow, temperatures can quickly rise to danger level and the prawns will be subjected to low dissolved oxygen levels. This will cause many mortalities before you can finish harvesting all the animals.

### CULL HARVESTING

In this technique a seine net is pulled through the pond to remove market-sized animals. The net may be a simple seine or one constructed especially for the purpose (Annex 7), usually made of monofilament nylon, and provided with floaters, sinkers and sometimes a bag. The size of the seine you use depends on the size of pond you are using it for. Nets which are 2.5 m high with a length equivalent to 1.6 times the pond width are suggested. The mesh you choose depends on the size of animal to be marketed. Although stretched knot mesh sizes of as low as 0.7 inches (1.8 cm) are sometimes used where there is a market for small prawns, the usual recommended mesh size is 1.5-2 inches (3.8-5 cm).

Care must be taken to ensure that the bottom of your seine is kept on the bottom of your pond. If you do not, many prawns will escape beneath it. Preferably you should pull the seine down the long axis of the pond (this is why rectangular ponds of 30 m maximum width are preferred) so that the ends of the net are pulled along the banks of the pond (Figure 83). Seining different halves of the pond once every two weeks avoids disturbing the whole of the pond at once.

The amount of prawns collected by the seine should not exceed that quantity which can be rapidly taken out of the seine, and transferred to a live box, a cage, or an impounded area for sorting. Many prawns, especially smaller ones, die when the bag of a bag seine is lifted out of the water if the quantity is too great. One way to ensure that the seine does not get overloaded because a whole pond is being seined is to stretch two seines across the middle of the pond. Firstly, while one seine is staked in position to retain the prawns in one half of the pond, pull the other seine to the end of the pond and harvest it. Then pull the first seine to the opposite end of the pond (Figure 84).

Ponds which are too wide to harvest by pulling each end of the seine down the long sides of the pond can also be seined but not so efficiently. You will have to repeat the seining operation several times, keeping one end stationary and pulling the other end in a semicircular fashion (Figure 85). If some of your labourers beat the surface of the water with sticks it will discourage the prawns from escaping the open end of the net as it is pulled toward the bank. Circular 'breeding' depressions are often seen in drained freshwater prawn ponds. These interfere with seining operations because large males can use them to evade the seine. Pond bottoms should be kept as even and smooth as possible. You should remove these depressions between rearing cycles.

Generally speaking, the more men you have available to help with seining, the more



You can cull-harvest your ponds by seining the pond towards one end

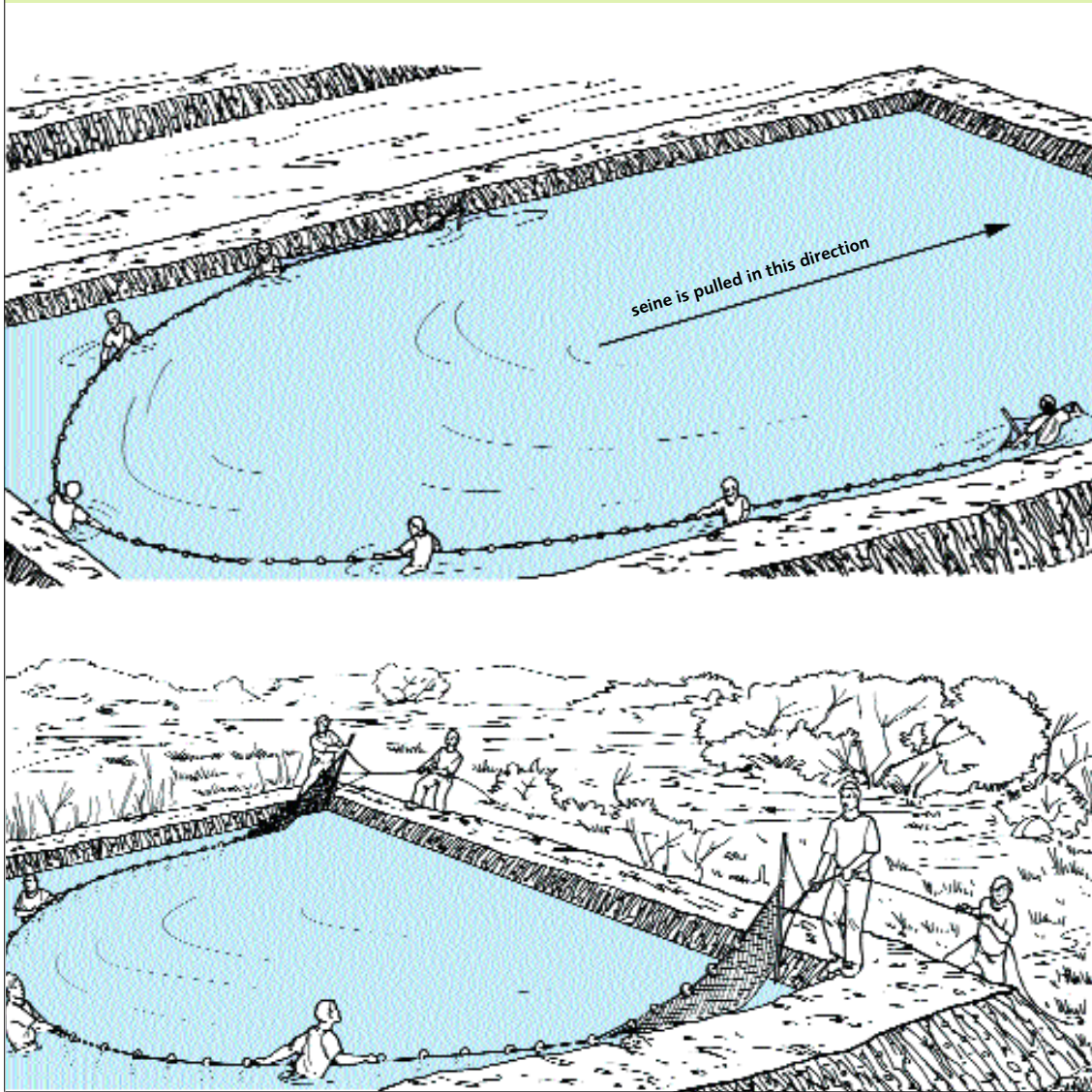

SOURCE: EMANUELA D'ANTONI

efficiently you can perform this task (provided there is one clear leader!). Three to five people can pull a seine net through a 30 m wide pond and seven to ten men can cope with a 50 m wide pond. A single-seined 0.2 ha pond takes about two to three hours to cull harvest using three or four people. Some farms claim that they can cull-harvest and sort the prawns caught from a 1 ha pond with 5 people in less than 2 hours but this may not maximize the catch of harvest-sized animals. You can put a temporary harvesting enclosure within the pond during seine-harvesting (Figure 86). This enables you to keep the prawns alive as long as possible (you may be going to sell them alive) and to sort them into different categories.

Transfer the prawns that you have seined to a holding tank or net (Figure 87) quickly. From this, you can sort them into different categories (by size, sex, berried females, etc.) to suit your market. Figure 88 shows a holding net being held near the pond inlet to main-

# FIGURE 84

In a longer pond you may find it easier to carry out seining operations with two nets

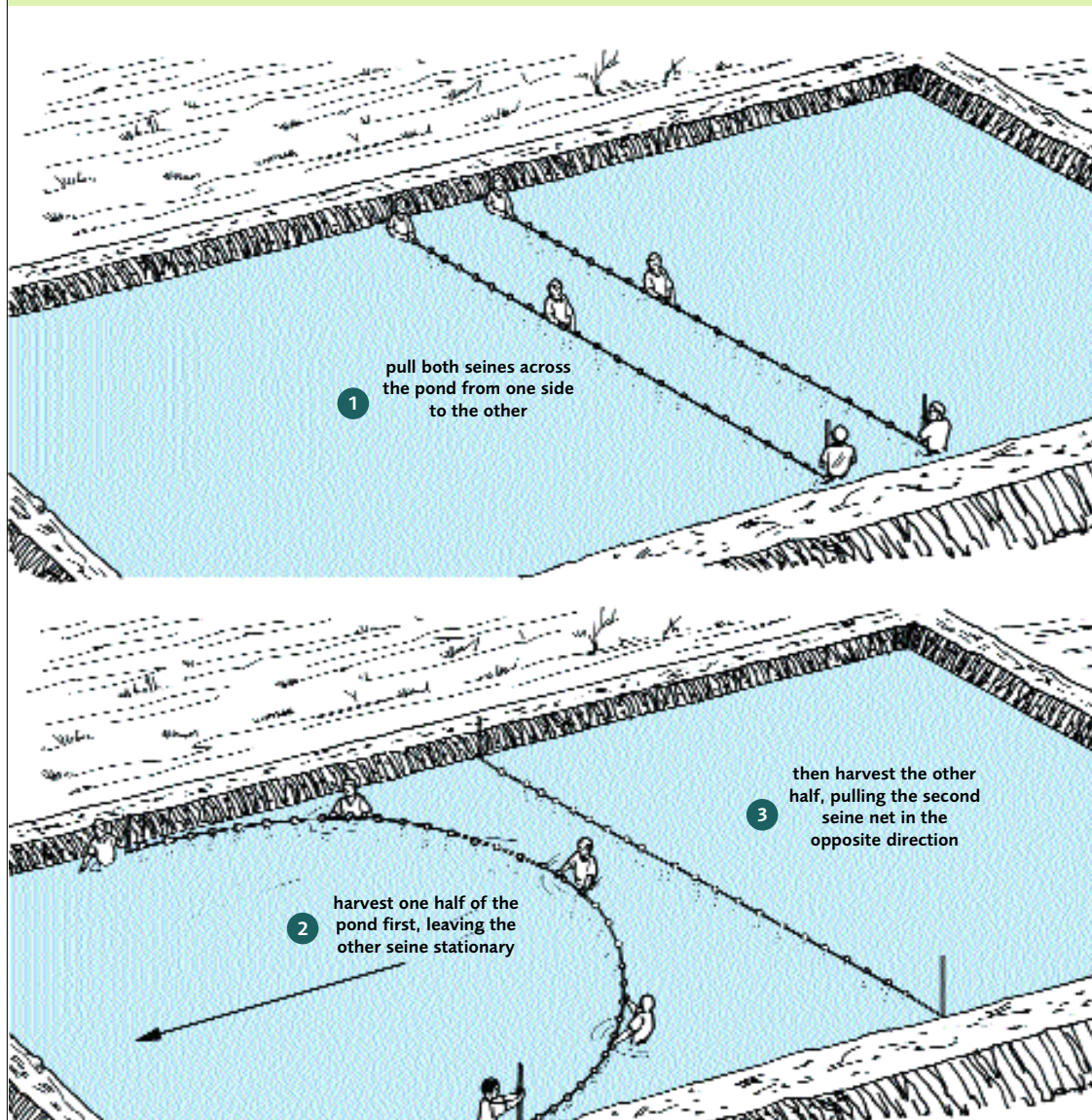

SOURCE: EMANUELA D'ANTONI

tain good water quality, and therefore high survival. Market sized animals should be retained for sending to the market; smaller animals should be returned to the original or to another pond. The measurement of market-sized animals during the sorting operation can be done by a quick check of total length. Tying rulers to the operators hands is a useful way of training them to do this but experienced harvesters quickly learn to judge sizes quite accurately. Remember that cull-harvesting is a good time to examine the health of your prawns (Figure 89).

Further details of seining techniques are contained in another FAO manual (FAO 1998,) which also illustrates other methods of partial harvesting, such as cast nets and lift nets.

Larger ponds may also be cull-harvested by making several seining operations; beating the water surface with a stick can help to keep the prawns from escaping from the open end of a seine before it is brought to the side of the bank

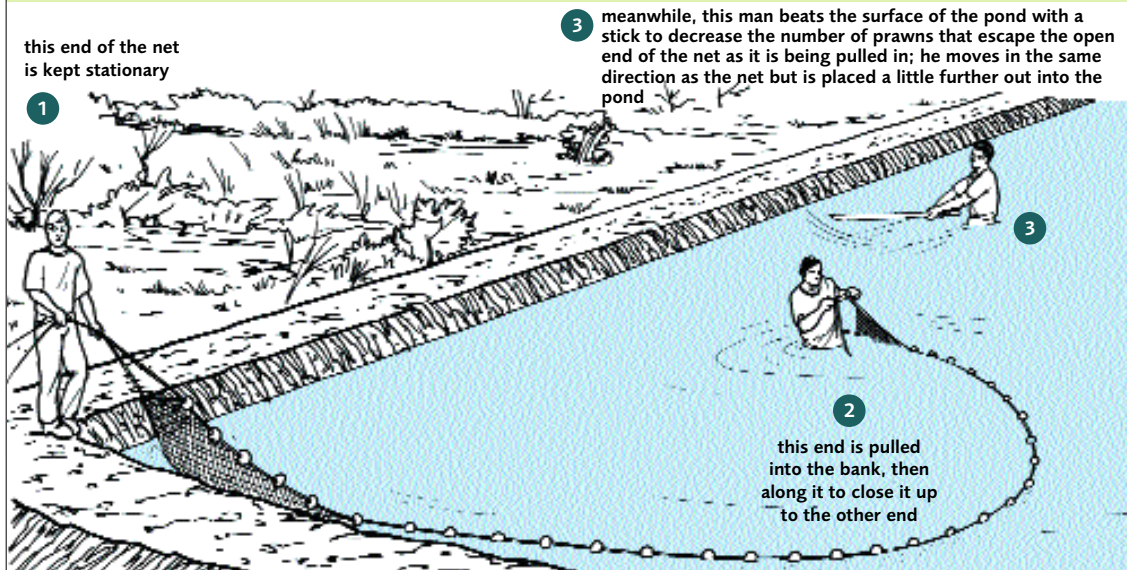

SOURCE: EMANUELA D'ANTONI

### DRAIN HARVESTING

The method and efficiency of drain harvesting depends on the design of the pond. As with any other method of harvesting, speed is important and harvesting should start very early in the morning while the temperature is cool. You can partially draw down the pond water level during the night before harvesting commences.

If your pond has a 'monk' or sluice gate structure for drainage, you can include a harvesting sump (catch basin) in front of the gate (Figures 90 and 91) or outside the pond. Details of drain harvesting structures are given in another FAO manual (FAO 1998). Efficient total harvesting can best be achieved through the addition of a catch basin within a drainable pond. As you drain the pond, prawns will accumulate in the basin. You must be careful to avoid oxygen deficiencies in the sump; you can prevent this by providing aer-

Figure 86  
Sorting prawns while seine harvesting

Figure 87  
Market sized freshwater prawns can be kept alive while harvesting continues (Martinique)



SOURCE: SPENCER MALECHA



SOURCE: MICHAEL NEW

**Figure 88**  
Prawns destined to be sold alive need clean and well-oxygenated water to keep them in peak condition (Martinique)



SOURCE: MICHAEL NEW

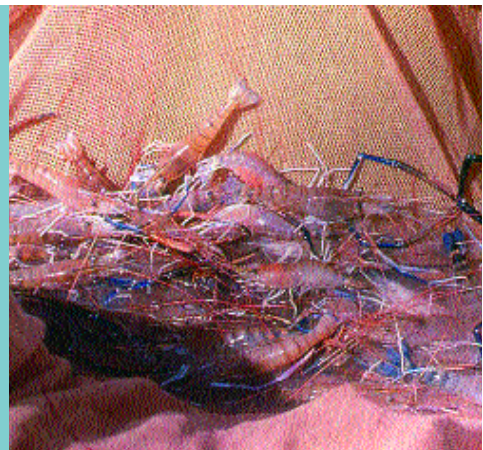

SOURCE: DENIS LACROIX

**Figure 89**  
Cull-harvesting or sampling is an opportunity to check the health of your prawns

ation or by having a continuous flow of new freshwater through the catch basin. Minimizing prawn stress (e.g. caused by low dissolved oxygen levels, high temperatures, crowding) during harvesting is extremely important. Having the correct outlet structure dimensions becomes particularly and obviously important when drain harvesting takes place. If the outlet pipe of the pond is too small, the pond will take much too long to drain (Table 14) and many of your animals will die before harvesting is completed. If your pond has been properly constructed, very few prawns will become trapped on the pond bottom during draining. In ponds with added substrate, these habitats can be left in place. The prawns will move out of the substrate to the catch basin as the water level drops.

## FIGURE 90

An internal harvesting sump can be used for *Macrobrachium rosenbergii* during drain-harvesting

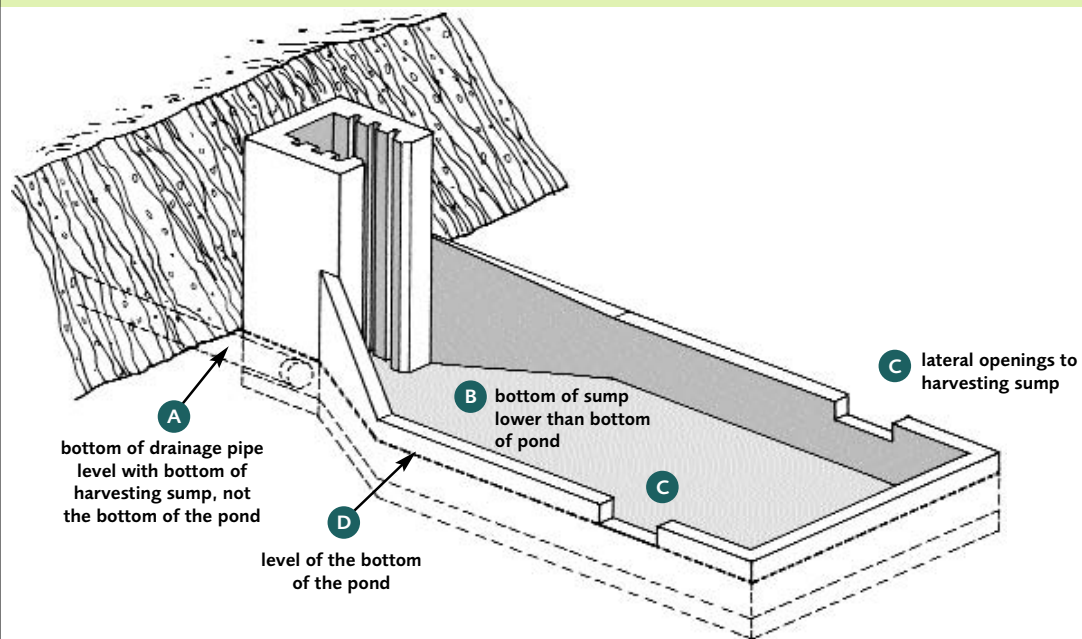

SOURCE: EMANUELA D'ANTONI

**Figure 91**  
Harvesting  
*Macrobrachium*  
*rosenbergii* from  
ponds with an  
internal harvesting  
sump (Brazil)



SOURCE: WAGNER VALENTI

If your pond does not have a monk or sluice gate you will have to drain it by pumping. Prawns must be prevented from entering the pump by means of a screen. Long-tail pumps, as shown in Figures 60 and 61, can be used. If you are harvesting this type of pond you will need to catch most of the prawns by multiple seining of the pond while draining takes place (Figure 92). As the water level gets low, many prawns will retreat

into the mud or become stranded in isolated pools of water. At this stage there is no substitute for catching by hand (Figure 93). If you have problems with stranded prawns at this time you will wish that you had been more careful to construct your pond with a good slope towards the drain and a well compacted, smooth surface. Another typical result of poor pond drainage is the target that stranded prawns provide for birds. Birds love harvest time (Figure 94)!

In temperate regions the harvesting of the total pond population of prawns must occur before water temperatures drop below 17°C. However, some animals may attain marketable sizes 4 to 6 weeks

before final harvest. 2-3 cull-harvests may be beneficial to spread the marketing season over a longer period.

Good handling and processing really begin at the pond bank. You need to take special care during harvesting to avoid the 'mushiness' which processed freshwater prawns have often been accused of. This effect is not unavoidable; it is caused by poor harvesting and processing. Do not allow your prawns to become 'stacked up', either in a net or in a harvest basin; this causes damage to the internal organs which results in poor quality prawns when sold. If you are not going to sell your prawns live, you should immediately wash them in clean water, kill them in a mixture of water and ice at 0°C, and then wash

**Figure 92**  
Cull-harvesting  
freshwater prawns  
several times  
before drain  
harvesting  
increases the yield  
of market-sized  
animals in your  
crop (Martinique)



SOURCE: MICHAEL NEW

**Figure 93**  
The last few prawns may have to be caught by hand, especially when the pond does not drain well (India)



SOURCE: STEPHEN SAMPATH KUMAR

**Figure 94**  
Bird predation causes problems during drain harvesting (Hawaii)



SOURCE: SPENCER MALECHA

them in chlorinated water (5 ppm active chlorine). This process, which preserves product quality, must be carried out near the pond, usually on the pond bank. Transporting live prawns to processing facilities before this treatment is carried out is not recommended because some prawns will die during transport and become ‘mushy’. No subsequent treatment can improve the texture of such prawns. When you are planning to sell the prawns live, take special care to reduce stress and minimize harvesting damage as much as possible, to ensure long-term post-harvest survival. You can achieve this by aerating or supplying a little clean water to the harvest basin (see Figure 91) and holding the prawns in clean, aerated holding tanks at temperatures preferably of about 20-22°C.

## 7.2 Handling your prawns after harvest and ensuring good product quality

In general, the value of your harvested product will depend on its quality. Speed during and after harvesting, getting the prawns on ice and out of the sun, and care in handling to prevent physical damage, will all reap valuable dividends. Farmed prawns should be better than the wild-caught product in every way and it is up to you to see that your hard-won harvest does not deteriorate through poor harvesting and post-harvest procedures.

The handling of freshwater prawns after harvesting was thought to be beyond the scope of the original FAO manual on freshwater prawn culture; very few recommendations were made at that time. However, much more is now known about the effects of handling on prawn quality (and therefore value). The following section of the manual has been derived mainly from the work of Madrid and Phillips (2000) and especially from the experience gained in a Costa Rican farm operated by one of those authors.

### HANDLING PRAWNS TO BE SOLD FRESH

If you intend to sell your prawns fresh (instead of selling them alive or frozen) you will need to keep them very cool, after the pond-side pre-processing described earlier has been done. You should not allow your prawns to die from asphyxia by leaving them out of water. Harvesting mud as well as prawns is a source of microbial contamination. You should not place live prawns straight onto ice; this results in a slow decline in body temperature, causes stress, and accelerates the deterioration process which occurs after death. As noted in the harvesting section of this manual, prawns which are not going to be sold live should immediately be washed in clean water and killed in a mixture of water and ice at 0°C

(Figure 95). To kill a batch of 50 kg of prawns, for example, immerse them in 50 L of water and 80 kg of ice for 30 minutes. Finally, you should wash them in chlorinated water (5 ppm active chlorine). If supplies are locally available, full-strength seawater which has been chlorinated has been found to reduce the incidence of ‘mushiness’.

After killing, remove your prawns from the cold water and immediately place them in isothermal boxes, with alternate layers of ice and prawns, placing ice in the first and last layers. Make sure your ice has been made from clean chlorinated water! Further information on the use of ice can be found in another FAO publication (Graham, Johnston and Nicholson 1993). You can then refrigerate your prawns at 0°C for short-term on-farm storage for sale as fresh prawns, or for transport to market or processing facilities (-10°C is not necessary and is much more expensive in terms of equipment and running costs). You are recommended not to keep prawns refrigerated at 0°C for more than 3 days; 5 days is the

absolute maximum. Do not use large blocks of ice for storage or transport on ice because they will damage the prawns; use flaked or crushed ice.

### HANDLING PRAWNS TO BE SOLD FROZEN

If you are not going to sell your prawns within 5 days of harvest, which is considered to be their maximum practical refrigerated shelf life, you need to freeze them immediately. These prawns need the same care and attention as those sold fresh. Always remember that freezing does not improve the quality of the prawns; at best it will preserve them in the quality they show at the time of freezing. Freezing at temperatures below -10°C is essential; storage at -20°C or below is recommended; storage at -30°C is ideal. To avoid physical damage to the muscle structure of the prawns, it is recommended that the freezing temperature passes from -1°C to -5°C as rapidly as possible (not more than 2 hours). This decreases

the production of ‘drip’ (leak) at the moment of thawing, and keeps the prawns looking and tasting the same as before freezing. If you freeze them more slowly it will cause large crystals to form in the water between the cells of the animals and increase ‘drip’. Keeping prawns frozen on-farm is generally not good practice, except on very large farms where specialist equipment has been installed. Otherwise it is best to sell them to professional processors who know how to care for the product properly.

Despite this advice, domestic freezers are often used by small farmers to freeze and store prawns. This does increase their shelf life but it can damage the texture of the flesh. You must not try to freeze prawns by placing them straight into domestic freezers because it results in the most frequent criticisms of prawns, namely that they are ‘mushy’. Domestic equipment should only be used for very small amounts of prawns that are already very cold when first placed into the freezer. It is important that you keep the prawns in contact with the base of the ‘freezer’, or with the shelves where the refrigerant liquid passes. As the thickness of the layers of prawns increases, the freezing time increases in a geometric proportion. When you withdraw prawns from a freezer, do not let any which you do not immediately intend to use thaw out. Replace them into the freezer before they thaw.

**Figure 95**  
If you are not marketing your freshwater prawns alive, you should kill-chill them in a bath of iced water immediately after harvesting to get the best quality (Puerto Rico)



SOURCE: DENIS LACROIX

**Figure 96**  
Freshwater  
prawns need  
sorting while  
being  
processed  
(Brazil)



SOURCE: MICHAEL NEW

Newly frozen prawns should be put in the back of the storage facilities and the prawns at the front used first. This technique for ensuring freshness is sometimes referred to as 'FIFO' (first in, first out). You must always avoid the alternatives, which could be called 'FILO' (first in, last out) or 'FISH' (first in, still here).

If your farm is large and you intend to freeze your own prawns the best solution is to use special processing and

freezing equipment and packaging (Figures 96 and 97). This topic is beyond the scope of this manual but an introduction can be found in Madrid and Phillips (2000) and more details in another FAO publication (Johnston, Nicholson, Roger and Stroud 1994).

If your market prefers it, you can pre-cook your prawns before freezing (Madrid and Phillips 2000). The appearance of cooked versus uncooked prawns is shown in Figure 98.

### HANDLING FOR LIVE SALES

Sometimes you will want to sell your prawns alive, either at your farm gate or after transport to markets and (especially) restaurants. These prawns also require careful, but different handling; the techniques are similar to those used to sell other live aquatic products. You will need to change your holding and transport water regularly to eliminate ammonia build-up. Keep the dissolved oxygen level above 5 ppm with aeration. Prawns to be transported live should be washed in non-chlorinated clean water and then brought to the same temperature that can be maintained during transport to prevent thermal shock through sudden transfer into water of a totally different temperature. It is recommended that you keep the transport temperature at about 20-22°C. Use small amounts of ice, if necessary, to keep this temperature constant. Transport techniques similar to those used to transport prawn postlarvae from hatcheries to distant grow-out facilities by road transport (as

**Figure 97**  
Package  
your prawns  
attractively  
(Mauritius)



SOURCE: YANN VON ARNIM

**Figure 98**  
Freshly  
harvested (blue)  
*Macrobrachium  
rosenbergii*  
can be cooked (pink)  
at the pond-side  
to provide a  
tasty barbeque  
(Brazil)



SOURCE: MICHAEL NEW



described earlier in this manual) are suitable. In general, restaurants and shops or market stalls selling live prawns will have aquariums to display them. You are recommended, for best quality, not to keep live animals in these aquaria for more than five days before sale and consumption.

### 7.3 Code of practice for harvesting, processing and handling prawns

---

Detailed technical guidelines and essential requirements for the harvesting, processing and handling of prawns, which apply both to those that are caught from open waters or obtained through farming, is contained in the relevant international code of practice, which is continuously updated (FAO/WHO 2001).



# Marketing

**THIS TOPIC WAS NOT DEALT** with in the original FAO manual on freshwater prawn farming but it is hoped that its inclusion in this new manual will be useful. The information presented has been derived from Phillips and Lacroix (2000).

For marketing purposes harvested prawns are sometimes divided into a number of groups:

- large or 'bull' males (including both BC and large OC);
- small males (SM) which are mostly not seen until the drain harvest takes place, unless they are trapped by the seine;
- egg-bearing (berried) females;
- immature or spent females;
- soft shelled (newly moulted) prawns; and
- 'terminal growth' prawns.

Good quality harvested prawns have a greenish or bluish tint with bright blue or orange chelipeds (claws).

## 8.1 Marketing your freshwater prawns alive

Marketing prawns alive will usually generate a better price for you but, of course, increases your costs. Marketing them successfully in this way depends on your ability to keep them alive during transport and display, and to present undamaged, healthy prawns in an attractive way. Good survival of adult freshwater prawns can be achieved during journeys of up to at least 24 hours at a density of 600 g/L with good aeration, without any visible deterioration in their quality. It is best to transport the prawns on shelves stacked vertically within the water column; this helps to avoid mortalities caused by crowding, as well as maintaining better localised water quality. Cool transport (20-22°C) minimizes water quality problems and reduces the activity of the prawns, thus lessening the likelihood that there will be injuries due to combat. The use of hard water tends to stabilize the pH, thus reducing the toxicity of any ammonia that builds up during transport.

Once the prawns arrive at the point of sale (e.g. restaurant, market) they can be maintained fairly densely packed in aquariums with a good biofilter. In some places, specialist firms collect live prawns from various farms, using small pickups with tanks and aeration devices. They may also buy, at a lower price, fresh (chilled) prawns. Another alternative is for you to join with other farmers to form a cooperative for this purpose. The key to success is to adapt to the needs of the local market in order to secure the highest income. In some places, small prawns can be sold as bait to fishermen; in others there is a recreational fee fishing (angling) market for live prawns themselves. In yet others there is an opportunity to sell live animals for home aquaria and for instructional use in schools. Caution must be used in areas where *Macrobrachium rosenbergii* is not indigenous, however, to ensure that they do not escape and endanger local fauna.

## 8.2 Marketing your freshwater prawns fresh or frozen

---

Prawns can be sold fresh (chilled) if they are going to be consumed within 5 (preferably 3) days. The way to ensure that your chilled prawns are of the best quality has been explained earlier in this manual.

Prawns which are not expected to be sold within 3 days should immediately be frozen. Freezing should take place when they are fresh, not after they have been on ice for several days. Frozen tails have a longer shelf life than whole prawns. Whole frozen freshwater prawns will turn 'mushy' if they are frozen and held above -20°C, or if they are thawed and refrozen. It is recommended that prawns to be stored for long periods be held at -30 to -35°C. Tails which are frozen in ice blocks may be stored for over a year and still be very satisfactory, although a maximum of six months is recommended. Glazing or vacuum packing significantly prolongs the useful life of frozen prawns. While vacuum packing requires elaborate processing facilities, not available to small farms, glazing is quite simple: a very thin mixture of syrup and water prevents oxidation. If you are marketing frozen prawns, whether they are sold whole or as tails, the ideal is to sell them within a three month period. This can be achieved, if your farm is geared properly to your market (when and where will the product be required, and in what quantity). Good record keeping will help you to develop an efficient farm management system, based on past experience. If you are selling prawns to restaurants you may find it useful to provide them with advice on how to ensure that they are consumed at their best quality (Table 20).

A high quality image can be established if you begin by selling at high prices to expensive and well-respected restaurants. These tend to demand high quality, which can help you to develop good products. Selling prawns to high-quality restaurants requires more effort for a new farm but it will pay off in the long term. Going for this market and establishing your quality image first enables you to obtain higher price levels when you start selling larger quantities of prawns.

## 8.3 Marketing your freshwater prawns at your farm gate

---

You may want to sell your prawns on your farm or at your 'farm gate', or even along the roadside. Usually, prawns sold in this way are marketed whole and fresh (chilled). This is a particularly sensible way to market at least some of your harvest, especially if your farm is situated on a busy road or near a tourist site. You can sell prawns at lower prices than people can buy them in shops or markets but at prices greater than you would get if you sold them to a retailer. If your farm is large enough, or you can obtain prawns from neighbouring farms, it may be worth building your own prawn restaurant.

TABLE 20 General recommendations to restaurants and consumers for handling and storing freshwater prawns

RECOMMENDED	NOT RECOMMENDED
Store <b>fresh prawns</b> in a refrigerator, covered with ice, for not more than 5 (preferably 3) days; change the ice daily and, while doing so, rinse the prawns with clean cold water	Do not thaw more prawns than you need; re-freezing thawed prawns is not good practice
Store <b>frozen prawns</b> in a freezer immediately you get them; keep them at minus 20°C or below until you need them	Do not take longer than 10 minutes to thaw prawns
Cook and serve prawns immediately after removing them from ice or thawing them	Do not leave prawns unprotected in the freezer; keep the container closed
<b>Cooked prawns</b> can be frozen	Do not ever leave prawns at room temperature

SOURCE: PHILLIPS AND LACROIX (2000)

Advertise your prawns (and/or your restaurant) with roadside signs, such as flags, balloons and banners (Figure 99), and make the prawns available at times when the greatest number of people pass by your farm. You could open up every day, or advertise that you were (for example) open every Thursday. You may find it worth buying in farmed fish (or perhaps you produce these as well as freshwater prawns) for resale in order to make your roadside stand more useful to the customers. Roadside sales are the most profitable and are paid for mostly in cash. Tell people how to store and cook what they buy. The sale of other items, such as T-shirts, caps, handicrafts, etc., may provide additional income.

If your farm is large you may find it useful to offer prawns at a discounted price to your labourers; this discourages theft. However, the price must not be so far below normal market price that you end up providing your labourers with an incentive to buy larger quantities than they need, so that they can resell them!

Another marketing idea worth thinking about is to make your farm a tourist attraction. Many people are very interested in aquaculture and would enjoy visiting your farm. If you do this, make sure that visitors cannot interfere with farm operations. Several farms in the French West Indies offer tourists the opportunity to buy freshwater prawns and to

visit the farms and test Caribbean traditional recipes in a restaurant located nearby.

If you do decide to sell all or part of your prawns at the farm, or by taking your own stand at a local market, it is very important that you should ensure that you do not damage the consumer image of your product. The prawns must not only be obviously clean and attractive looking but also be chilled or frozen

Figure 99  
Advertise your freshwater prawns at the farm gate (Martinique)



SOURCE: DENIS LACROIX

properly. They should also be displayed in clean and hygienic conditions. Those selling the prawns must be clean and properly dressed.

## 8.4 International opportunities and general marketing strategy

---

The international marketing of freshwater prawns, which (except in the case of the largest farms) would be made through intermediary seafood processing companies, is outside the scope of this manual. When the first FAO manual on freshwater prawn farming was written there were very few opportunities for export; now, freshwater prawns are beginning to become a global commodity. *Macrobrachium* is commonplace in the supermarkets of

Europe and the USA and is widely used in the restaurant trade. It is therefore important for you to realize that there are now significant opportunities for exporting your product, if it is of export quality (Figure 100).

Information on the global market for freshwater prawns can be obtained through the GLOBEFISH Databank run by the FAO Fish Utilization and Marketing Service (<http://www.globefish.org>)



**Figure 100**  
Supermarkets sell *Macrobrachium rosenbergii* in Europe (France)

SOURCE: DENIS LACROIX

The development of marketing strategies and plans for freshwater prawns is covered in Phillips and Lacroix (2000) and a number of case studies are presented. That publication also contains many recipes for preparing meals containing *Macrobrachium*; good knowledge about the proper preparation of this species before consumption is thought to be very important to generate a good consumer image of the product. This is especially important in countries where *Macrobrachium* is not indigenous and there is no tradition in its cooking. A range of farm-gate and retail prices for freshwater prawns in several countries is provided in New (2000b).

# Key to larval stages of freshwater prawns (*Macrobrachium rosenbergii*)

**THIS ANNEX PROVIDES** a simplified key to the eleven larval stages of *M. rosenbergii* and is illustrated with some micro-photographs kindly given to the author by the late Takuji Fujimura (Annex 1, Figures 1 - 12). The most prominent characteristics are shown in Annex 1, Table 1.

**ANNEX 1**  
TABLE

## 1 Selected characteristics of *Macrobrachium rosenbergii* larvae and postlarvae

STAGES	CHARACTERISTICS						
	Eyes	Rostrum	Antennal flagellum	Uropod	Telson	Pleopods	Pereiopods
<b>I</b>	sessile						
<b>II</b>	stalked						
<b>III</b>		1 dorsal tooth		first appearance			
<b>IV</b>		2 dorsal teeth		biramous with setae			
<b>V</b>			2 or 3 segments		more elongated and narrower		
<b>VI</b>			4 segments		more narrow	first appearance of buds	
<b>VII</b>			5 segments			biramous and bare	
<b>VIII</b>			about 7 segments			biramous with setae	
<b>IX</b>			about 9 segments			endopods with appendices internae	
<b>X</b>		3 or 4 more dorsal teeth	about 12 segments				1st & 2nd fully chelated
<b>XI</b>		many dorsal teeth	about 15 segments				
<b>PL</b>	rostrum has dorsal and ventral teeth; behaviour predominantly benthic, as in adults						

SOURCE: DERIVED FROM ISMAEL AND NEW (2000)

ANNEX 1, Figures 1-12

*Macrobrachium rosenbergii* go through eleven distinct larval stages (Figures 1-11) before metamorphosing to become postlarvae (Figure 12)



1



2

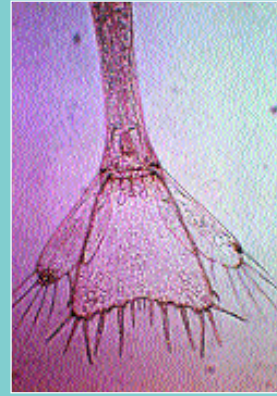

3



4



5

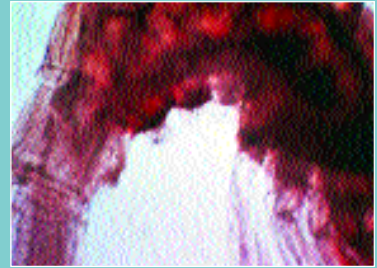

6



7



8



9



10



11



12

SOURCE: TAKUJI FUJIMURA

# Natural beach filter for seawater

**SUITABLE BEACHES** can be used as natural seawater filters for hatcheries. Some hatcheries draw water from perforated pipes protected by a 150 µm nylon screen buried approximately 1 m deep in the beach. However, the screens are prone to damage and it is better to develop the beach itself as a filter. This annex describes a cheap filter probe made from plastic, which is derived from a stainless steel probe developed by a zoologist, the late George Cansdale. The following notes have been extracted from Suwannatous and New (1982). The system is easy and cheap to make and is described here in spite of some scepticism that such simple systems are effective.

## 1. Basic requirements and capacity

---

Careful thought should be given to the location of the beach filter. A permeable beach is needed, with a depth of 2-3 m under a minimum of 30 cm water. Beaches of a wide range of types may be used, including sand, gravel, broken coral, shell, etc. The bulk of the sand grains should be between 0.5 mm and 5.0 mm but a great advantage of this system is that, during the development of the filter, excess fine sand is pumped out, leaving the larger grains in and around the filter probe; thus a precise sand specification is not needed. Uniformly fine sand, especially of wind-blown origin, is unsuitable on its own, but it can be graded up by adding coarse sand or gravel under and around the unit. If most grains are above 2 mm diameter, it helps to add fine sand on the surface around the unit during development. 'Fine sand' is defined for the purposes of this annex as material up to 1 mm and 'coarse sand' from 2 mm to 5 mm, but these are not technical terms. A few stones in the beach of up to 50 mm do not prevent it being developed as a filter bed but larger stones will reduce the efficiency of the filter and should be cleared away (or a different site chosen). Sites with little or no sand are not suitable for natural beach wells. Those with soft mud cannot be used. Where the beach is rocky some people have found that excavating a large hole and filling it with sand from another site, into which the filter probe is inserted, is effective. However, this may be very difficult and costly to construct and maintain. If the hatchery site is not adjacent to a beach with a favourable structure for a beach well there are a number of choices, including choosing a better site, bringing seawater (or brine) from another location (this is essential for inland hatcheries anyway), or pumping raw seawater and treating it within the hatchery.

The equipment described in this annex can be installed in any suitable beach. When this system was developed the original probes were constructed of stainless steel, which is expensive. However, cheaper plastic pipes can be used, provided the probes are taken up and cleaned more frequently.



The capacity of the pump required to operate the filter probe and the jet probe (see section 3), and the correct pipe diameter, depends on the water requirements of the hatchery, as well as its elevation above sea level and the distance between the pump and the filter probe, and between the pump and the seawater holding tank in the hatchery. It is important to have no noticeable flow resistance at the maximum water flow required. Equipment should not be too large for the characteristics of the site and the amount of water required by the hatchery, because this will result in excessive capital costs. Conversely, buying equipment which is too small for the site is a waste of money. The choice of pipe size is discussed in detail in an FAO manual (FAO 1992b). As an example of pump capacity, a 3 HP, 1 440 RPM self-priming electric pump sucking water from a filter probe 35 m distant through a 10 cm flexible hose (adapted down to 5 cm near the pump) and delivering water through a 10 cm pipe to a hatchery above the highest high-water mark to a site 350 m distant is capable of pumping about 20 m<sup>3</sup>/hr of seawater.

## 2. Construction of the filter probe

---

Soften the end of a 1.5 m piece of 10 cm diameter PVC pipe with heat, taper it to a point, and make sure that it is sealed. Then cut three sets of slits into it (Annex 2, Figure 1). The three sets of slits should be cut in rings. The lowest set should be 20 cm from the bottom of the pipe and the space between the three sets of rings should be 40 cm. From the upper set of slits to the top of the pipe should measure about 45 cm. Each ring of slits should be 2.5 cm long. The individual slits should be 1-2 mm wide and the spaces between them 1 cm wide. Flow can be increased by inserting more rows of slits but care must be taken not to weaken the pipe so much that it will fracture.

## 3. Installation and operation of the filter probe

---

Ideally, the filter probe should have at least 30 cm water above it at spring low tide. In very permeable sand on a level beach, a unit can sometimes be installed above low tide mark; it must be inserted as deep as possible. However, unless water has free access to it at all times, flow from probes inserted above low tide mark may be limited when the tide is out. Sea movements are daily and predictable, and a known factor in the suction head. Tidal pattern may vary widely: rise and fall may be from less than 2 m to over 15 m and the tide may recede anything from a few metres to over 500 m.

Dig a soft area in the inter-tidal zone of the beach, using a jet probe (use a pipe similar to the filter probe but with a tapered open end and no slits) connected to the outlet side of the pump that will later be used for water extraction. The closer you can get to the low-water mark the better, but you need to be able to get access to the probe for maintenance. Then fix the flexible hose to the top of the filter probe and push it into the softened sand to a depth of about 1.5 m. When it is in position, move the other end of the hose to the intake side of the pump and start extracting water, letting it flow to waste. The well will need 'developing', as explained below, before the water is of quality high enough to use in the hatchery. Once the well has been developed, connect the outlet side of the pump to the pipe supplying the seawater holding tank in the hatchery.

Where quality is critical, the water should be analysed and its quality monitored. In any case, the salinity of the water should be monitored during beach well site selection to make sure that it is high enough for the requirements of the hatchery (for freshwater prawn hatcheries, for example, it must always be higher than 12 ppt); in some areas the water sucked from a beach well may have been diluted to levels below this by freshwater run-off or beach springs.

Good quality water can sometimes be obtained with simple beach filters; this figure illustrates a simple plastic beach filter probe

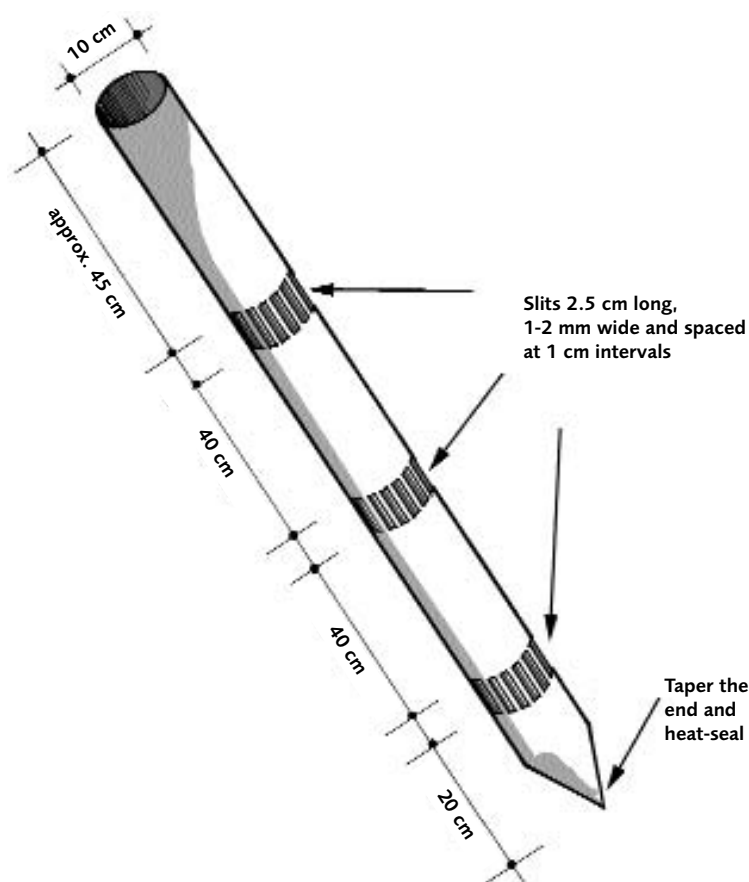

SOURCE: EMANUELA D'ANTONI

#### 4. Developing the efficiency of the filter

The area of beach around the filter probe becomes the natural 'beach filter'. Before it operates to the best efficiency it needs development. Thorough development is the key to success and this section of the annex is most important.

When the filter probe is buried and the suction line has filled with water, this is then connected to the pump intake. Tight joints with washers are essential, for the smallest air leak delays priming and lowers efficiency. Underwater leaks may admit raw water; however, if these are very small, they soon block. The filter can be developed with a temporary pump close to the water. When the pump is fully primed, reduce its speed until it runs steadily. At first the water will be full of silt and organic matter as it cleans the bed. Depending on the site, the water will become clear in anything from a few to many minutes. Stop the pump and then re-start it; after a very short interval the water will become dirty but then it will soon clear. When this happens, stop and re-start the pump again. Releasing the partial vacuum disturbs the sand in and around the probe. This allows more fine material to be sucked out and gradually pushes back the perimeter of clean coarse sand, thus improving flow. This result is the main reason why the filter needs development so that it will work efficiently. Continue the alternate stopping and re-starting process until water no longer becomes dirty after restarting, and the pump is working to full capac-

ity. The type of beach and the pump size determines how long this process will take. Where the beach has a lot of black organic matter, development is best spread over several days to allow this to decay aerobically, after which it is easily sucked out.

The water should now be crystal clear, free of all suspended matter and organisms down to about 1 micron (1  $\mu\text{m}$ ) or less. Where particularly high quality water is needed (i.e. for research work), the seawater should be pumped to waste for several hours daily for at least a week (while the biological filter is developing in the beach filter). The time needed for this varies with temperature and other factors.

Where adverse site conditions impede progress, the following procedures may be tried:

- using a jet probe, dig the beach well in the area where the filter probe is to be inserted, and let the current carry away much of the silt;
- instead of just stopping the pump momentarily during development, release the suction completely, letting the water flow right back to the filter probe before re-starting the pump;
- interchange the intake and outlet hoses and reverse the water flow so that water is pumped through the filter probe into the beach for several minutes. Somebody needs to hold the probe in position during this process, to make sure that it does not become dislodged.

Small amounts of sand may be drawn through for some days, especially when pumping is periodic, but this is sterile and can easily be settled in a primary tank or small baffle chamber.

If the filter is only used intermittently it is good practice to pump some water to waste each time it is re-started; this need be for only a few minutes if the time since it was last used is only a day but should be about an hour if the filter has not been used for a week. Local experience will show how long water needs to be pumped to waste on each occasion.

## 5. Maintaining the efficiency of the filter

There is a tendency for the flow of water passing through any filter to gradually decrease, as the spaces between the filter bed particles become blocked. In marine sites tidal and wave movements generally keep the surface of the beach filter clear. If blocking does occur, this will only be in the top 1-3 cm, usually only the top 1 cm. If the flow from the filter becomes reduced, and this is not due to declining pump performance or other factors, this suggests that there is surface blocking. This can be cured in several ways, including:

- stopping the pump and raking an area of about 5 m radius around the probe, working to a depth of about 5 cm, then pumping the water to waste and redeveloping the filter for as long as needed;
- skimming off about 3 cm of sand from the surface and replacing it with new sand;
- forking the area over lightly and back-washing the filter by moving the suction hose to the pump outlet and drawing water through a spare hose. Somebody needs to make sure that the probe does not become displaced during this operation;
- moving the filter probe to another area and developing a new beach filter. A firmly embedded filter probe can be quickly freed by changing over suction and delivery hoses at the pump and blowing back, after letting some air into the line.

A change in tidal pattern or a badly sited breakwater may cause a metre or more of sand to be removed from the beach, though this is unlikely near or below low tide mark. If the filter probe becomes exposed because of this type of problem, it must be re-installed and re-developed.

# Maturation diets for broodstock freshwater prawns

**BERRIED FEMALES** brought into the hatchery just before their eggs hatch are not normally fed. If they are, they can be given the normal grow-out diet. However, if broodstock are being maintained for long periods, it is best if you use a diet which encourages maturation. Some simple methods of supplementing grow-out feeds for this purpose are described in the section of the manual on broodstock. Annex 3, Table 1 shows two formulae for specific broodstock diets which have been shown to be effective for this species.

ANNEX 3  
TABLE

1

## Broodstock diets for *Macrobrachium rosenbergii*

INGREDIENT	INCLUSION RATE (%)	
	BROODSTOCK DIET	BROODSTOCK DIET
	NO. 1	NO. 2
Fish meal	16.10	18.30
Soybean meal	25.00	25.00
Shrimp meal	35.00	35.00
Copra (coconut) meal	5.00	5.00
Wheat flour	16.54	6.08
Palm oil	1.31	9.57
Vitamin premix <sup>11</sup>	0.10	0.10
Vitamin C	0.10	0.10
Mineral mix <sup>12</sup>	0.10	0.10
Calcium propionate (preservative)	0.25	0.25
Binder <sup>13</sup>	0.50	0.50
<b>Total</b>	<b>100.00</b>	<b>100.00</b>
<b>Added BHT (antioxidant) (mg/100g)</b>	<b>0.80</b>	<b>2.00</b>

**SOURCE:** THESE TWO DIETS GAVE THE HIGHEST NUMBER OF EGGS PER G BODY WEIGHT OF FEMALE (APPROXIMATELY 1 355), THE LARGEST EGG DIAMETER (APPROXIMATELY 0.5 MM) AND THE HIGHEST HATCHING RATE (90% FOR DIET 1 AND 82% FOR DIET 2) IN A TRIAL WITH *MACROBRACHIUM ROSENBERGII* BY DAS, SAAD, ANG, LAW AND HARMIN (1996).

11 vitamin premix (per kg mix): 24 000 mg pyridoxine; 142 000 mg ascorbic acid; 23 700 000 IU vitamin A; 4 740 000 IU vitamin D; 24 000 mg riboflavin; 71 000 mg calcium  $\beta$ . pantothenate; 142 000 mg niacin; 24 000 mg thiamine; 12 000 mg folic acid; 12 100 mg vitamin B12; 100 mg biotin.

12 mineral premix (per kg mix): 15 270 mg copper (Cu); 100 450 mg iron (Fe); 97 500 mg manganese (Mn); 1 190 mg iodine (I); 159 180 mg zinc (Zn).

13 type not stated.

# Source, hatching and enrichment of *Artemia*

**THERE HAVE BEEN** many publications on the use of *Artemia* as a live food since the original FAO manual on freshwater prawn farming was published in 1982. The following annex has been derived mainly from two other FAO publications (Lavens and Sorgeloos 1996; Moretti, Pedini Fernandez-Criado, Cittolin and Guidastri 1999) whose authors are hereby gratefully acknowledged. You are recommended to study these manuals for a thorough understanding of the topics in this annex.

## 1. Sources, quality and use of *Artemia* cysts for freshwater prawn larvae

---

*Artemia* cysts can be obtained in cans from commercial companies but originate in many different countries, including Brazil, China, Iran, the former Soviet Republics, and Viet Nam. The main source is still the Great Salt Lake in Utah, USA. Dry cysts (2 to 5% moisture) are very resistant to extreme temperatures (hatching viability is not affected in the temperature range -273°C to + 60°C and can even tolerate short exposure to temperatures between 60°C and 90°C. Hydrated cysts are far less tolerant. Mortalities occur below +18°C and above +40°C, and a reversible interruption of their metabolism occurs between -18°C and +4°C and between +33°C and about +40°C. Active cyst metabolism occurs between +4°C and about +33°C; hatching percentage is unaffected within this range but the nauplii hatch earlier at higher temperatures. When incubated in saline water, *Artemia* cysts swell up and become spherical within 1 to 2 hours (Annex 4, Figure 1).

After 12 to 20 hours of hydration, the cyst shell bursts (breaking stage) and the embryo, surrounded by the hatching membrane, becomes visible. The embryo then leaves the shell completely and hangs underneath the empty shell but may be still attached to it by the hatching membrane (umbrella stage). The hatching membrane is transparent and the development of the pre-nauplius into the instar I nauplius, which starts to move its appendages, can be viewed through it. Soon after this, the hatching membrane breaks open (hatching) and the free-swimming larva is born head first. Instar I nauplii cannot feed; thus, the older nauplii are when they are fed to freshwater prawn larvae, the more they will have used up the energy reserves with which they were born and the less nutritional value they will have for the prawn larvae. Instar II *Artemia* have used up 25 to 30% of their energy reserves within 24 hours after hatching (Merchie 1996). Instar II *Artemia* are also transparent and swim faster than instar I larvae; they are therefore less easy for prawn larvae to catch. Detailed information on the biology and ecology of *Artemia* is given in Van Stappen (1996).

*Artemia* cysts hydrate, break, have an 'umbrella' stage, and then hatch

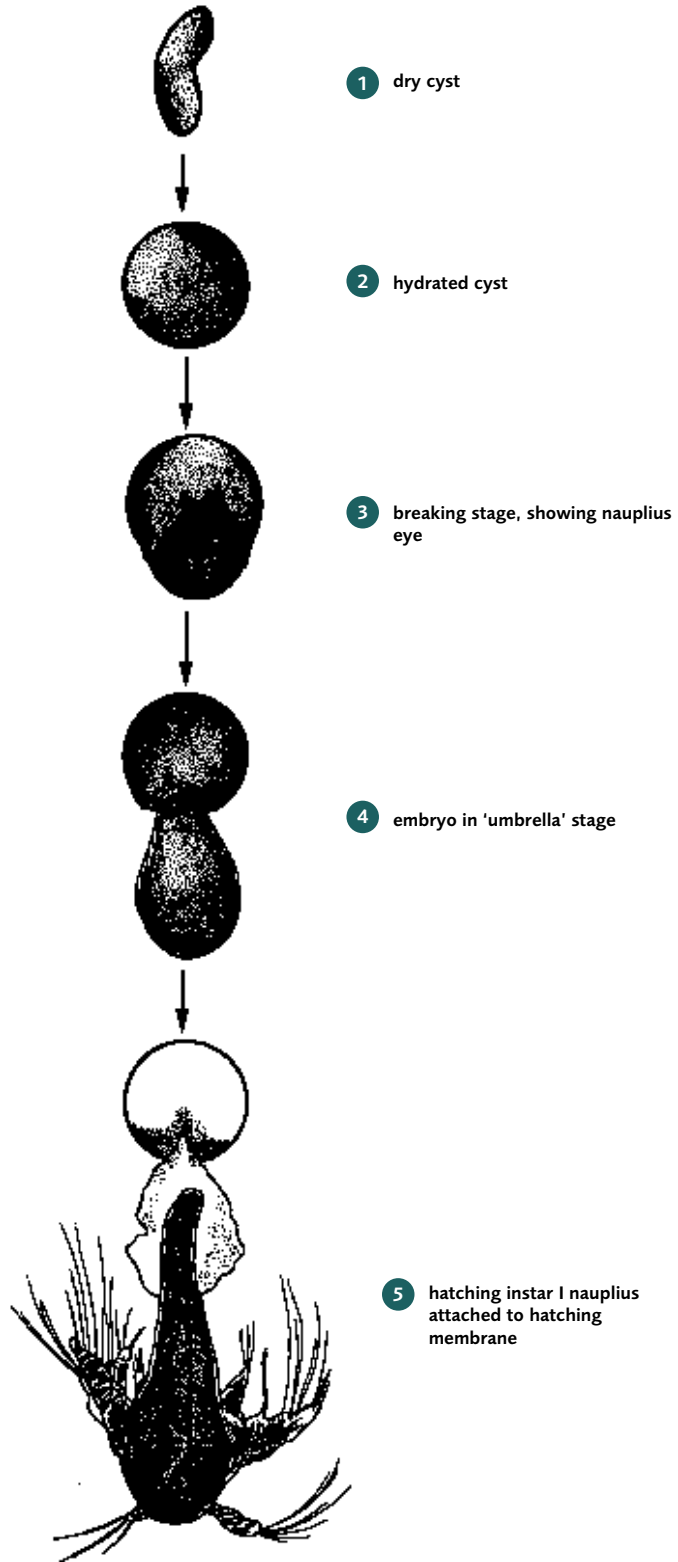

SOURCE: EMANUELA D'ANTONI

The nutritional quality and physical size of the nauplii which hatch from *Artemia* cysts (referred to elsewhere in this manual as brine shrimp nauplii – BSN) vary enormously from source to source and even (in the case of nutritional quality) between individual batches from a single source. Of particular importance is the level of an essential polyunsaturated fatty acid, eicosapentaenoic acid [EPA] (20:5n-3), which depends on the composition of the primary food available to the brine shrimp in the locations where they originate. Further reading on this topic can be found in Merchie (1996). The nutritional quality of *Artemia* nauplii (BSN) can be improved by enrichment, as described later in this annex. For practical purposes, cysts can be categorized by the size of the first stage nauplii they produce: small (~430 µm), medium (~480 µm) and large (~520 µm) but the size is not so important for freshwater prawns as it is for some marine fish. Freshwater prawns can ingest BSN of all sizes.

The two other important *Artemia* factors which vary from batch to batch are the number of cysts per gram and their hatching rate. The most effective way of checking the basic quality of the cysts you buy is to measure the hatching efficiency, because this is a check not only on the percentage of cysts that hatch but is also a means of judging how much detritus (e.g. empty cyst shells, sand, salt, etc.) that the batch contains. Hatching efficiency is defined as the number of BSN hatched per gram of cysts purchased. Premium quality cysts from the Great Salt Lake should yield about 270 000 BSN per gram of cysts. Smaller cysts (e.g. the San Francisco Bay source) may provide up to 320 000 BSN per gram of cysts. However, some sources yield as low as 100 000 BSN per gram of cysts. Good quality cysts should start to hatch after 12-16 hours incubation and all should have hatched by 24 hours (Van Stappen, 1996). This measure of quality is known as the hatching rate (HR). Hatching rate curves for two samples of cysts are illustrated in Annex 4, Figure 2. A procedure for determining hatching percentage, hatching efficiency and hatching rate is given in Annex 4, Table 1; this should be used to compare different sources of cysts, so that you know whether you are getting value for money or not.

Choosing to feed prawn larvae with 24 hour old or with 48 hour old (timed from when the cyst incubation process starts) BSN depends partly on the rate of *Artemia* hatching (characteristic of the source and the environmental conditions you supply it with) and partly on operator preference. Some hatcheries use 24-36 hour old BSN; others use 24-36 hour old BSN at first and progress to the use of larger 48 hour or 72 hour old BSN (reared on 'greenwater' or rice bran) as the prawn larvae grow. However, the use of 24 hour old BSN enables you to use the same equipment on a daily basis. Keeping BSN longer before using them is more expensive as producing food to rear them needs more equipment.

*Artemia* cysts need treatment before the hatching process commences to ensure maximum hatching occurs and to maintain healthy conditions in larval rearing tanks. This process is described below.

## 2. Treatment of cysts before hatching

---

*Artemia* cysts are by nature contaminated with bacteria, fungal spores, and other micro-organisms, and may be contaminated with organic impurities. The use of BSN which arise from cysts that have not been disinfected can cause health problems in larval rearing tanks; poor water quality and larval diseases (especially those caused by *Vibrio* spp.) can be introduced when untreated empty shells, unhatched cysts and cyst hatching water are transferred to the larval rearing tanks. The decapsulation process also disinfects the cysts

Determining the hatching rates of different sources and batches of *Artemia* cysts helps you (with other factors, such as cost and availability) to determine not only which cysts you should purchase but how to manage your hatching regime

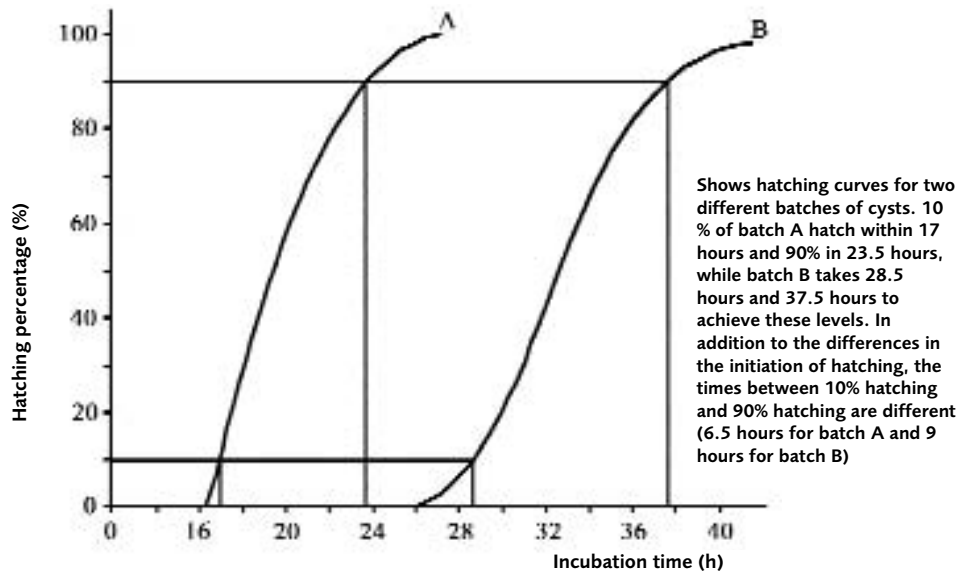

SOURCE: EMANUELA D'ANTONI, AFTER VAN STAPPEN (1996)

but has the additional advantages of increasing the hatching efficiency of some batches and reducing the transfer of indigestible matter to the larval rearing tanks.

### DISINFECTION

Commercially disinfected cysts may be available on the market but it is safer to apply routine disinfection. Simple disinfection can be done by immersing the cysts in a hypochlorite solution (200 ppm active chlorine), according to the procedure in Annex 4, Table 2. The procedure for preparing the disinfection solution is given in Annex 4, Table 3. After disinfection, some hatcheries remove residual chlorine with sodium thiosulphate but thorough rinsing of the treated cysts is regarded as adequate in others. However, while reducing the risk of contamination, disinfection does not kill all the organisms present in the outer shells of the cysts and is not recommended in this manual. Decapsulation (see below) is a more effective means of obtaining contaminant-free cysts, as well as potentially increasing hatching efficiency.

### DECAPSULATION

Decapsulation completely removes the hard shell that encapsulates the dormant *Artemia* embryos. This process is recommended because:

- although cyst shells can be physically removed after hatching non-decapsulated cysts (this is necessary because cyst shells are not digested and may obstruct the larval gut) this laborious process is completely unnecessary if the cysts are decapsulated;



- decapsulation improves the energy content of the BSN (which do not waste energy breaking their own way through the shell) and sometimes increases hatchability; and
- decapsulation is an efficient means of disinfection.

Decapsulation involves hydrating the cysts, removing the (then spherical) brown shells in a hypochlorite solution (500 ppm active chlorine), washing them and deactivating the remaining chlorine. Decapsulated cysts can be directly hatched into BSN, or filtered and stored in a refrigerator at 0-4°C for a few days before use, or transferred to a saturated brine solution for longer storage (up to several months). If stored, they must be protected from sunlight because the hatchability decreases when exposed to UV light.

Decapsulated cysts can be dried and fed directly (without hatching). However, this type of food is more appropriate for postlarvae because prawn larvae feed better on a moving target; this is one of the primary reasons for feeding them live BSN. Decapsulation involves the use of a source of hypochlorite, usually liquid bleach (NaOCl), and an alkaline product, usually technical grade caustic soda (sodium hydroxide, NaOH), to increase pH to above pH 10. Finally, the residual hypochlorite is neutralized with sodium thiosulphate. Details of the cyst decapsulation process are provided in Annex 4, Table 4 and the preparation of the active chlorine solution in Annex 4, Table 5. Commercial bleach varies widely in chlorine content, so it is essential to measure the chlorine content of each batch, as detailed in Annex 4, Table 6.

### 3. Hatching decapsulated *Artemia* cysts and harvesting nauplii (BSN)

Almost any type of container can be used for hatching *Artemia*, including rectangular and round tanks, cylindrico-conical tanks, garbage cans, modified drinking water containers (Annex 4, Figure 3), converted chemical carboys, 'klong' (water) pots (Annex 4, Figure 4) and other structures (Annex 4, Figure 5). However, several of those types of containers need to be siphoned to empty the BSN out after hatching. The easiest to use is a conical based circular plastic or fibreglass tank which is elevated so that the BSN can be harvested by gravity. A 1 m<sup>3</sup> volume tank is convenient. The upper parts of the tank should not be transparent; the conical part of the tank can be transparent or translucent and have a valve at the tip of the cone for harvesting purposes. A simple tank is illustrated in Annex 4, Figure 6). Aeration should be supplied through a half-inch PVC pipe which extends to close to the conical tip of the bottom of the tank; this is to keep the cysts in vigorous suspension, as well as

**ANNEX 4, Figure 3**  
Brine shrimp nauplii (BSN) can be reared in many different containers, including old drinking water bottles (Peru)



**SOURCE:** OSCAR ORBEGOSO MONTALVA

**ANNEX 4, Figure 4**

These 'klong' pots were being used to culture the larvae of *Macrobrachium rosenbergii* but are also sometimes used to rear *Artemia* (Thailand)



**SOURCE:** SPENCER MALECHA

**ANNEX 4, Figure 5**

These outdoor tanks are used to rear *Artemia* (Thailand)



**SOURCE:** HASSANAI KONGKEO

to keep the dissolved oxygen level above 4 ppm. The tanks should be filled with natural sea-water that has been filtered and is about 33-35 ppt in salinity (well-buffered artificial sea-water can also be used). The optimum hatching temperature is 25-28°C and the best hatching pH is 8.0-8.5. A solution of about 1 g of sodium bicarbonate ( $\text{NaHCO}_3$ )/L can be used to achieve this pH level, if necessary. The surface of the water at the top of the tanks should be illuminated at 2 000 lux. If the available sunlight is not sufficient, two 60 watt fluorescent tubes placed just above the tank rim is sufficient to achieve this level of light intensity. The hatching tanks should be elevated, to aid the harvesting process.

A one-ton ( $1 \text{ m}^3$ ) tank can be stocked with 250 g to 1 kg (0.25-1.00 g/L) of *Artemia* cysts. The actual amount needed depends on the source of cysts you purchase, and their hatching efficiency (see Annex 4, Table 1). No specific hatching efficiency (HE) is recommended. Your choice of cysts will be a matter of comparative cost and the results you obtain. Cheap low-quality cysts can be used but you will need more of them. The important thing is that the HE must be measured, so that you know the actual quantity of cysts you will need to obtain the number of BSN you need for your hatchery. A  $1 \text{ m}^3$  *Artemia* rearing tank stocked at this level should provide enough BSN to feed ten  $5 \text{ m}^3$  larval rearing tanks for one day, which are capable of producing 500 000 to 1 million freshwater prawn post-larvae per cycle. The hatching and harvesting procedure is given in Annex 4, Table 7.

## 4. Enrichment

The nutritional quality of BSN, especially in terms of the PUFAs eicosapentaenoic acid (EPA, 20:5n-3) and docosahexaenoic acid (DHA, 22:6n-3) can be increased by enrichment. Enrichment for disease control is also possible. These processes are sometimes known as boosting or bioencapsulation and are a feature in many marine fish and shrimp hatcheries, especially when older BSN are used (Annex 4, Figure 7).

Some advantages from enriching BSN with vitamin C have been clearly demonstrated by measuring the reaction of freshwater prawn larvae to stress testing when fed

starved *versus* enriched BSN. Lavens, Thongrod and Sorgeloos (2000) have suggested that the use of HUFA/vitamin C-enriched BSN would provide benefits to hatcheries which do not feed other HUFA- and vitamin-rich supplements (for example, included in EC diets) to larval freshwater prawns from stage V onwards. Several commercial enrichment products are now available and each supplier describes the practical enrichment process. Those *Macrobrachium* hatchery operators who wish to enhance the quality of their BSN should follow the suppliers' instructions. The names and suppliers of BSN enrichment products include Super Selco and DHA Selco (INVE Aquaculture NV., B-9080 Lochristi, Belgium), Superartemia (Catvis BV., 5222 AE 's-Hertogenbosch, Netherlands) and SuperHUFA (Salt Creek Inc., Salt Lake City, Utah 84104, USA). If you wish to study the topic of *Artemia* enrichment further, it is recommended that you read the details provided by Merchie (1996).

## ANNEX 4 FIGURE 6

### *Artemia* hatching container during harvesting

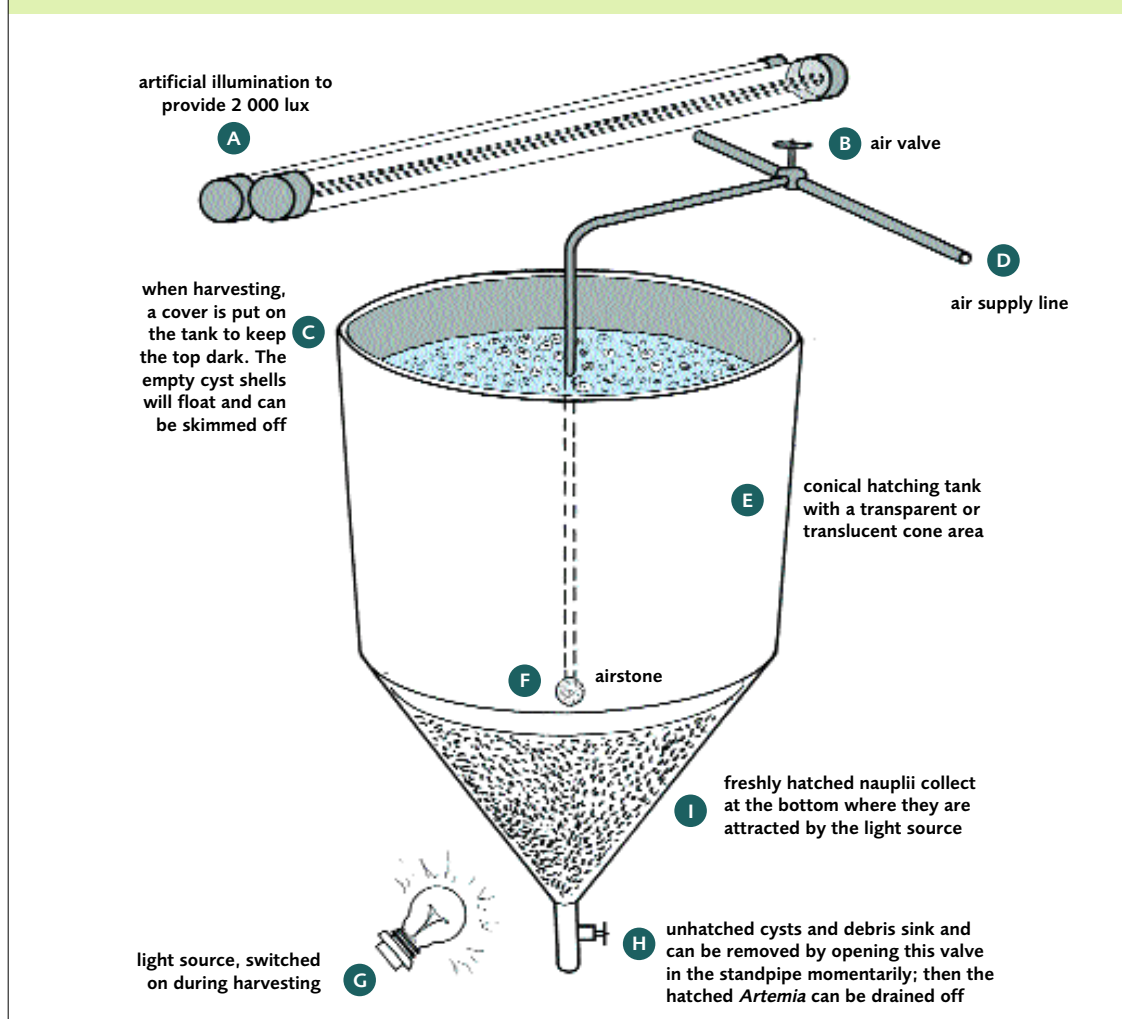

SOURCE: EMANUELA D'ANTONI, DERIVED FROM MERCHIE (1996)

BSN can be enriched to improve nutritional quality and (at least in fish culture) for the control of some diseases

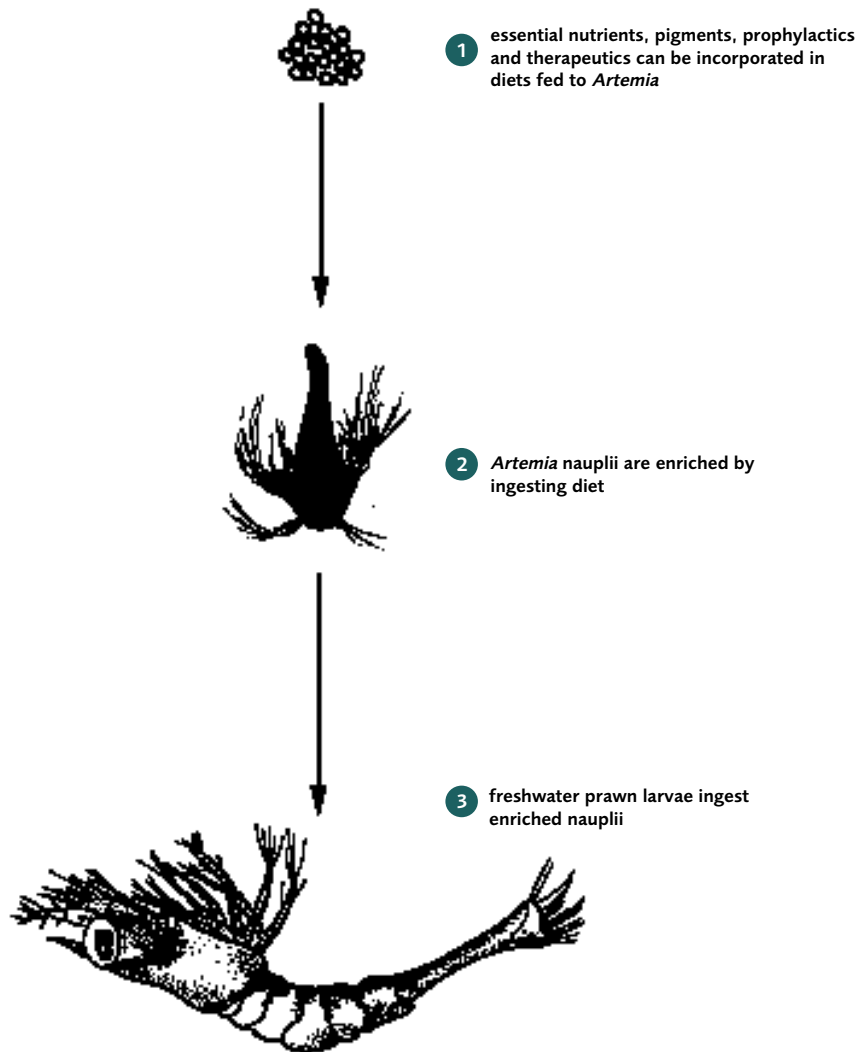

SOURCE: EMANUELA D'ANTONI, DERIVED FROM MERCHIE (1996)

**ANNEX 4**  
TABLE

# 1 Determining hatching percentage (H%), hatching efficiency (HE) and hatching rate (HR).

1.	In triplicate, incubate 1.6 g of cysts <sup>14</sup> in 800 ml of 33 ppt seawater under continuous illumination (2 000 lux) at 28°C in cylindrical-conical tubes (preferably) or in graduated cylinders, which are provided with aeration from the bottom sufficient to keep all the cysts in suspension but not so strong that foaming occurs.
2.	After 24 hours, take six 250 µl sub-samples out of each tube/cylinder. Pipette each into a small vial and fix the BSN by adding a few drops of lugol solution <sup>15</sup> .
3.	Using a dissection microscope, count the number of hatched BSN in each sub-sample and calculate the mean number (N). Also, count the number of umbrella stage embryos <sup>16</sup> (Annex 4, Figure 1) in each sample and calculate the mean number (U).
4.	Decapsulate the unhatched cysts and dissolve the empty cyst shells by adding one drop of sodium hydroxide solution <sup>17</sup> and 5 drops of domestic bleach solution <sup>18</sup> to each vial.
5.	Using a dissection microscope, count the unhatched (orange) embryos in each sub-sample and calculate the mean number (E).
6.	Calculate the <b>hatching percentage</b> (H%) for each sub-sample: $H\% = (N \times 100) \div (N + U + E)$ . Calculate the mean for each tube/cylinder and determine the mean value and standard deviation of the three replicates.
7.	Calculate the <b>hatching efficiency</b> (HE) for each sub-sample: $HE = (N \times 4 \times 800) \div 1.6$ (which can be simplified to $HE = N \times 2\,000$ ). Calculate the mean for each tube/cylinder and determine the mean value and standard deviation of the three replicates.
8.	The <b>hatching rate</b> (HR) can be determined by starting to take sub-samples after 12 hours incubation, followed by new sub-samples every three hours and calculating HE according to the procedure above. Sub-sampling should be continued until the HE becomes constant (maximum HE). Mean values at each sampling time can then be calculated and expressed as a percentage of the maximum HE. This enables you to construct a hatching curve (Annex 4, Figure 2) and make comparisons of the hatching rate of different cyst batches.

**SOURCE:** DERIVED FROM VAN STAPPEN (1996) AND MORETTI, PEDINI FERNANDEZ-CRIADO, CITTOLIN AND GUIDASTRI (1999)

**ANNEX 4**  
TABLE

# 2 Disinfecting<sup>19</sup> 1 kg of *Artemia* cysts

1.	Prepare 20 L of 200 ppm active chlorine solution (see Annex 4, Table 3).
2.	Add 1 kg of cysts and keep them in suspension by vigorous aeration for 20 minutes.
3.	Harvest the cysts on a 125 µm sieve and rinse thoroughly with plenty of tap water.
4.	Transfer the disinfected cysts into the hatching/incubation tank.

**SOURCE:** DERIVED FROM VAN STAPPEN (1996) AND MORETTI, PEDINI FERNANDEZ-CRIADO, CITTOLIN AND GUIDASTRI (1999)

14 it is important to use exact quantities of cysts and water, etc., in order to ensure that valid comparisons are being made.

15 lugol solution: Dissolve 50g potassium iodide (KI) and 25g iodine (I<sub>2</sub>) in 100 ml boiling water (= solution A). Dissolve 25 g sodium acetate (CH<sub>3</sub>COONa) in 250 ml water (= solution B). When solution A cools, mix solutions A and B and store in a cool dark place.

16 the umbrella stage is when the embryo hangs beneath the empty shell of the cyst, still within the hatching membrane.

17 dissolve 40 g NaOH in 100 ml distilled water.

18 5.25% NaOCl.

19 some of the chemicals used in disinfection and decapsulation are toxic and/or can cause burns. Wear gloves and protective eyeglasses.

Preparing a 200 ppm active chlorine solution  
for use in disinfecting 1 kg of *Artemia* cysts

- 1. Determine the percentage of active chlorine (% Cl)** in the commercial liquid bleach or bleaching powder (see Annex 4, Table 6). For this example, let us say that you find that your **liquid bleach** contains 11.9% Cl and your **bleaching powder** contains 69.6% Cl.
- 2. If you are going to use liquid bleach**, you need to calculate the quantity of liquid bleach needed in millilitres (A) to obtain 20 L of a 200 ppm solution. First you will need to know the strength of your liquid bleach (see # 1 above). If B is the strength of the solution you want to use in ppm (in this example, 200 ppm), C is the quantity of solution needed in ml (in this example 20 000 ml) and D is the strength of the original bleach in ppm (in this example, we are supposing (see # 1 above) that you have found that your liquid bleach is 11.9% active Cl; this is equivalent to  $11.9 \div 100 \times 1\,000\,000 = 119\,000$  ppm active Cl.), the amount of liquid bleach you need to dilute can be calculated as follows:  $A = B \times C \div D$ . In this example, you would therefore need to dilute  $200 \times 20\,000 \div 119\,000 = 33.6$  ml of the this batch of liquid bleach to 20 L with freshwater.
- 3. If you are going to use bleaching powder**, you need to calculate the quantity of bleaching powder needed in grams (A) to obtain 20 L of a 200 ppm solution. First you will need to know the strength of your bleaching powder (see # 1 above). If B is the strength of the solution required in ppm (in this example, 200 ppm), C is the quantity of solution needed in ml (in this example, 20 000 ml) and D is the strength of the original bleaching powder in ppm (in this example, we are supposing (see # 1 above) that you have found that your bleaching powder is 69.6% active Cl; this is equivalent to  $69.6 \div 100 \times 1\,000\,000 = 696\,000$  ppm active Cl), the amount of bleaching powder you need to measure out can be calculated as follows:  $A = B \times C \div D$ . In this example, you would therefore need to dissolve  $200 \times 20\,000 \div 696\,000 = 5.75$  g of this batch of bleaching powder in 20 L of freshwater.
- 4. You now have 20 L of a 200 ppm active chlorine solution**, sufficient to disinfect 1 kg of cysts.

SOURCE: DERIVED FROM VAN STAPPEN (1996) AND MORETTI, PEDINI FERNANDEZ-CRIADO, CITTOLIN AND GUIDASTRI (1999)

1.	Calibrate two 20 L plastic buckets: one with a mark at 10 L (bucket A) and the other at 14 L (bucket B).
2.	Hydrate 1 kg of cysts in bucket A, making the volume up to 10 L with either freshwater or seawater for 1 hour at 25°C, provided with strong aeration.
3.	While the cysts are hydrating, prepare the decapsulation solution (see steps 4-7 below).
4.	Measure out the equivalent of 0.5 g of active chlorine (see Annex 4, Table 5) and place in bucket B. If you are using bleaching powder, this must be dissolved in water before step 5.
5.	Add 150 g of sodium hydroxide (NaOH) to bucket B if you are using liquid bleach. If you are using bleaching powder, add 670 g sodium carbonate (Na <sub>2</sub> CO <sub>3</sub> ) or 400 g of calcium oxide (CaO) instead of the NaOH.
6.	Fill bucket B up to the 14 L mark with seawater. Cool the mixture in bucket B to 15-20°C by placing the bucket in a bath of ice water.
7.	Provide strong aeration and, if available, antifoam.
8.	After 1 hour, collect the cysts from bucket A on a 125µm mesh sieve and transfer them to bucket B. Now the decapsulation process will start.
9.	Keep the cysts in suspension (by means of the aeration) for 5-15 minutes. The decapsulation process generates heat, so it is important to keep the contents of bucket B as close as possible within 25-30°C (and never above 40°C, which is lethal for the cysts): add ice, if necessary, to ensure overheating does not occur.
10.	Check the decapsulation process under a binocular microscope. The cysts will change colour from dark brown to grey (when you are using bleaching powder), or orange (when you are using liquid bleach). This is the colour of the <i>Artemia</i> nauplii, seen <b>through</b> its outer cuticular membrane. The cysts can also be checked for the level of flotation, using a pipette or graduated cylinder. Non-decapsulated cysts float; decapsulated cysts sink.
11.	As soon as decapsulation has occurred (it is essential not to leave the cysts too long in the decapsulation solution, or their viability will be adversely affected), harvest them on a 125 mm mesh sieve and rinse them thoroughly with plenty of tap water until no further smell of chlorine can be detected.
12.	Remove the residual chlorine by dipping them in a 0.1% sodium thiosulphate (Na <sub>2</sub> S <sub>2</sub> O <sub>3</sub> ·5H <sub>2</sub> O) solution for about 5 minutes; then rinse them again. [The presence of residual chlorine can be detected by putting a few decapsulated cysts in a small amount of starch-iodine indicator (starch, potassium iodide, sulphuric acid, water): the chlorine has been removed when the reagent no longer turns blue.]
13.	The rinsed and decapsulated cysts can <u>either</u> be transferred directly into the hatching/incubation tank <u>or</u> they can be stored.
14.	<u>Short-term storage</u> (up to one week) can be achieved by rinsing, draining and keeping the decapsulated cysts under refrigeration (0-4°C).
15.	<u>Longer-term storage</u> can be achieved if the cysts are dehydrated by placing them in a saturated brine solution. 10 L of brine (300 g NaCl/L) are needed for each 1 kg of cysts. The cysts will need to be drained and the brine solution replaced once or twice at the beginning. Then the cysts can be stored under brine for a few months when kept in a refrigerator.

SOURCE: DERIVED FROM VAN STAPPEN (1996) AND MORETTI, PEDINI FERNANDEZ-CRIADO, CITTOLIN AND GUIDASTRI (1999)

<sup>20</sup> Some of the chemicals used in disinfection and decapsulation are toxic and/or can cause burns. Wear gloves and protective eyeglasses. All decapsulation operations should be carried out in a well-ventilated room. Gloves and protective eyeglasses should be worn.

ANNEX 4  
TABLE

## 5 Obtaining 0.5 g of active chlorine for use in decapsulating 1 kg of *Artemia* cysts

1. **Determine the percentage of active chlorine** (% Cl) in the commercial liquid bleach or bleaching powder (see Annex 4, Table 6). For this example, let us say that you find that your liquid bleach contains 11.9% Cl and your bleaching powder contains 69.6% Cl.
2. **If you are going to use liquid bleach**, calculate the quantity needed to provide 0.5 g of active chlorine in millilitres (A) as follows. First you will need to know the strength of your liquid bleach (see # 1 above). If B is the quantity of active chlorine needed (in this example 0.5 g) and C is the percentage of Cl in the liquid bleach (in this example 11.9%), you can calculate the amount of liquid bleach as  $A = B \times 100 \div C$ . In this example, you would therefore need to measure out  $0.5 \times 100 \div 11.9 = 4.20$  ml of liquid bleach.
3. **If you are going to use bleaching powder**, calculate the quantity needed in grams (A) as follows. First you will need to know the strength of your bleaching powder (see # 1 above). If B is the quantity of active chlorine needed (in this example 0.5 g) and C is the percentage of Cl in the bleaching powder (in this example 69.6%), you can calculate the amount of bleaching powder as  $A = B \times 100 \div C$ . In this example, you would therefore need to measure out  $0.5 \times 100 \div 69.6 = 0.72$  g of bleaching powder.
4. **You now have the amount of active chlorine that you need** (0.5 g) for the decapsulation process for 1 kg of cysts.

SOURCE: DERIVED FROM VAN STAPPEN (1996) AND MORETTI, PEDINI FERNANDEZ-CRIADO, CITTOLIN AND GUIDASTRI (1999)

ANNEX 4  
TABLE

## 6 Measuring the level of chlorine in commercial liquid bleach or bleaching powder

1. Dissolve 0.5-1.0 g potassium iodide crystals (KI) in 50 ml distilled water and add 5 ml of glacial acetic acid ( $\text{CH}_3\text{COOH}$ ), or enough to reduce the pH to between pH 3.0-4.0.
2. Add 1.0 ml of either the **commercial liquid bleach** ( $\text{NaOCl}$ ) or 1.0 ml of a solution which you have made of the **bleaching powder** [consisting of 15.00 g of the bleaching powder ( $\text{Ca}(\text{OCl})_2$ ) in 100 ml of distilled water].
3. Using standard 0.1N sodium thiosulphate ( $\text{Na}_2\text{S}_2\text{O}_3 \cdot 5\text{H}_2\text{O}$ ), titrate (away from direct sunlight) until the yellow colour of the liberated iodine has almost disappeared, add 1 ml starch indicator<sup>21</sup>, and titrate until the blue colour disappears.
4. Calculate the level of active chlorine in the bleach solution. 1 ml of 0.1 N sodium thiosulphate = 3.54 mg active chlorine.
5. **Example of calculation for commercial liquid bleach:** if 33.5 ml of sodium thiosulphate are required to reach the end point of the titration, there is  $33.5 \times 3.54 = 118.59$  mg of active chlorine in 1 ml of the commercial bleach solution. The level of active chlorine in the liquid commercial bleach is therefore  $118.59 \times 100 \div 1\,000 = 11.9\%$  Cl.
6. **Example of calculation for bleaching powder:** if 29.5 ml of sodium thiosulphate are required to reach the end point of the titration, there is  $29.5 \times 3.54 = 104.43$  mg of active chlorine in 1 ml of the solution of bleaching powder which you made for the titration. The level of active chlorine in the original bleaching powder is therefore  $104.43 \times 100 \div 15 \div 1\,000 \times 100 = 69.6\%$  Cl.

SOURCE: DERIVED FROM VAN STAPPEN (1996) AND MORETTI, PEDINI FERNANDEZ-CRIADO, CITTOLIN AND GUIDASTRI (1999)

<sup>21</sup> prepare starch solution by mixing 5 g of starch ( $\text{C}_6\text{H}_{10}\text{O}_5$ )<sub>n</sub> with a little cold water and grind in a mortar; pour into 1 L of boiling distilled water, stir and settle overnight; use the clear supernatant, preserved with 1.25 salicylic acid ( $\text{C}_7\text{H}_6\text{O}_3$ ) and store in a dark bottle.



## 7 Procedure for hatching *Artemia* cysts and harvesting nauplii

<p><b>1.</b> Set up the hatching tank.</p>
<p><b>2.</b> Stock the hatching tank with (decapsulated) cysts at a density of 0.25-1.00 g/L. As described earlier, you must determine the HE before deciding the actual quantity of cysts you need to use.</p>
<p><b>3.</b> Incubate for 22 hours (it is essential for the BSN to be harvested when they are still energy-rich; older BSN would need feeding to maintain their nutritional quality for feeding to freshwater prawn larvae).</p>
<p><b>4.</b> When ready to harvest the BSN, stop the aeration, cover the top of the tank to exclude light and focus a strong light source (say a 150 watt lamp) near the bottom of the tank to attract the BSN to that area. Fit a flexible hose to the outlet of the tank and run it to the harvesting container which contains seawater and has an internal 125-150 µm mesh filter.</p>
<p><b>5.</b> Purge the bottom tip of the tank of any unhatched cysts by opening the drain valve or removing the drain plug for a few seconds.</p>
<p><b>6.</b> Not later than 5 minutes after stopping aeration (longer will cause oxygen depletion), start to collect the hatched BSN in the filter (see step 4 above) by gravity flow, by opening the drain valve or removing the drain plug. During the harvesting process, the dissolved oxygen level must not be allowed to fall below 2 ppm. Some hatcheries inject pure oxygen to raise the DO<sub>2</sub> level to 10 ppm before harvesting to ensure that levels do not fall too low during harvesting. Do not drain the hatching tank completely or you will also collect any empty shells which may be floating on the surface of the water. You may find it useful only to harvest the tank partially; then wait another ten minutes for more BSN to accumulate near the light source, and harvest again. Be careful not to let the hatching tank drain faster than about 100 L/minute; watch carefully so that you do not clog the screen and lose BSN into the surrounding water of the hatching container.</p>
<p><b>7.</b> Rinse the BSN thoroughly (about 15 minutes) to wash out the hatching debris. Either seawater or freshwater is suitable for rinsing.</p>
<p><b>8.</b> Place the BSN from the filter into a temporary aerated container with a known but small volume of filtered sterilized 12 ppt brackishwater. This enables you to minimize the transfer of seawater to larval rearing tanks with the BSN and accustoms the BSN to the larval rearing salinity. It also enables you to calculate the amount to add to each freshwater prawn larval rearing tank at each feeding time, as described in the manual under hatchery procedures. Ideally, you should estimate the quantity of BSN present now, so that you can determine how to feed your prawn larvae the correct amount. However, in routine practice (and if you have added a quantity of cysts based on your measurement of the quality of each batch of cysts that you purchase) this may not be necessary.</p>
<p><b>9.</b> Feed the BSN to the prawn larvae as soon as possible (with the minimum transfer of water).</p>
<p><b>10.</b> If the BSN are not going to be fed immediately, store them in another aerated cylindrico-conical storage tank containing filtered and sterilized seawater and adjust the water volume to a known level to give a maximum density of 4 million BSN/L. Keep the water temperature cool (5-10°C) with sealed ice bags to retain the nutritional quality of the BSN. This inhibits moulting, thus conserving energy and maintaining the nutritional value of the BSN for freshwater prawn larvae.</p>
<p><b>11.</b> Start a new batch (repeating steps 1-10), so that you have BSN ready for tomorrow's feeding. The number of batches you need at any one time, and the time of day to start the hatching process for each BSN batch depends on the number of freshwater prawn larval cycles you have in your hatchery and the larval stage that each batch has reached. Remember that you will be starting to reduce the number of feeds of BSN from day 5 onwards and that, by day 10 you will only be feeding BSN in the evenings.</p>

SOURCE: DERIVED FROM VAN STAPPEN (1996) AND MORETTI, PEDINI FERNANDEZ-CRIADO, CITTOLIN AND GUIDASTRI (1999)

# Production of farm-made larval feeds

**MANY DIFFERENT** farm-made feeds can be used in the rearing of freshwater prawn larvae, in addition to the feeding of brine shrimp nauplii (BSN). This annex describes the preparation of three versions of an egg custard diet (EC) and the use of fish flesh. The first EC diet is an egg-mussel mixture. Experience has shown that using fish flesh (larval diet No. 4), especially when carelessly prepared or overfed, can be a grave source of water pollution in larval rearing. Farm-made larval diets No. 1 and No. 3 are the most simple to prepare.

## Farm-made larval diet No. 1:

Prepare as follows:

- blend 0.5 kg of shelled mussel (other molluscs can be used, but mussel seems best) in a blender;
- strain the chopped mussel through a coarse cloth and discard the connective tissue, retaining only the material which passes the strainer;
- using the whole of the mussel which has passed the strainer, add three or four whole eggs and stir thoroughly in the blender (note: it is important to use the white as well as the yolk of the egg - the white contains good quality protein - some people think using the white of the eggs causes water pollution but it does not if homogenized properly);
- steam the mixture over water (like poaching an egg) until it solidifies into a custard;
- screen to the correct size (see the main text of the manual) and feed directly; or
- you can refrigerate it for a few days for later use (however, the quality of frozen EC is not as good as fresh EC for feeding purposes).

## Farm-made larval diet Nos. 2 and 3

Prepare as in larval diet No. 1 but use the ingredients shown in Annex 5, Table 1.

## Farm-made larval diet No. 4

Skipjack tuna, bonito or mackerel are good types of fish to use when preparing this feed. It may also be used as an ingredient in larval diet No. 1 above, partially or totally replacing mussel. The results with mussel seem to be superior.

Prepare the fish as follows:

- fillet the fish, discarding head, bones and viscera;
- grind and liquidize the flesh, as for the mussel in larval diet No. 1, in a blender;
- force the flesh through stainless steel sieves with a strong jet of freshwater (this

grades the particles and washes the flesh free of blood and excess oil). The mesh sizes should be chosen to produce particles of a size relevant to the age of the prawn larvae (see the main text of the manual);

- use the fish flesh directly; or
- form into balls of known weight for storage (it may be kept in the refrigerator for 2-3 days or frozen for longer periods; however, frozen material is less satisfactory than fresh).

**ANNEX 5**

**TABLE**

**1**

**Ingredients for farm-made larval diets Nos. 2 and 3**

INGREDIENTS	QUANTITY OF INGREDIENTS	
	LARVAL DIET NO. 2	LARVAL DIET NO. 3
Fish meal	100 g	-
Skimmed milk	250 g	9 g
Whole (yolk and white) duck eggs	10 eggs	-
Whole (yolk and white) chicken eggs	-	6 eggs
Freshwater	250 ml	300 ml
Wheat flour	250 g	-
Vitamin C	5 tablets	-
Vitamins A and D	50 drops	-
Vitamin B complex	5 tablets	-
Tetracycline	5 capsules	-
Calcidol	10 ml	-

**NOTE:** TETRACYCLINE HAS BEEN USED IN LARVAL DIET NO. 2; YOU SHOULD READ THE TEXT OF THE MANUAL CONCERNING THE DANGERS OF REGULARLY USING ANTIBIOTICS IN HATCHERIES.

**SOURCE:** DERIVED FROM LAVENS, THONGROD AND SORGELOOS (2000)

# Stock estimation

**ESTIMATING OF THE NUMBER** of animals present under hatchery or pond conditions is difficult. The four critical times when it is important to assess the number (and sometimes the size) of prawns present in the system are:

- **when postlarvae are harvested**, to provide a record and an assessment of the production efficiency of each larval batch and tank;
- **when postlarvae are transferred** from the hatchery to the pond, to control stocking density and determine feeding rates;
- **at intervals during the grow-out period**, to check growth rate and survival; and
- **when market-sized prawns are harvested**, to provide a final or cumulative record (an assessment of the productivity of the pond and management system being used).

The following methods are suggested for stock estimation.

## 1. Stock estimation when postlarvae are harvested

The following system is suggested:

- a) before the harvested PL are transferred to the PL holding tank, suspend them temporarily in a small container with a known volume of aerated water;
- b) agitate the water thoroughly to evenly disperse the animals;
- c) take four samples from the container in 100 ml beakers;
- d) now place the bulk of the postlarvae into the holding tank (do not wait until the sample counting process is complete);
- e) count every animal in each of the four 100 ml beakers (one way of doing this is to take quantities into a graduated pipette held at a 45° angle towards a lamp and to count the animals as they swim up towards the light);
- f) average the number of postlarvae found in each 100 ml beaker and multiply this number by the volume of water in the container mentioned in (a) above (in ml) and divide by 100.

The following is an example of the calculation for a postlarval stock estimation:

Let us assume that the small container [see (a) above] had a volume of 25 L. You counted 80, 86, 90 and 100 postlarvae in the four beakers [see (e) above]. The total number of postlarvae in the 25 L container can be calculated as follows:

Average number of PL in 100 ml =  $(80 + 86 + 90 + 100) \div 4 = 89$

Number of PL in the 25 L container =  $89 \times 25 \times 1\,000 \div 100 = 22\,250$

## 2. Stock estimation when postlarvae are transferred to nursery or to grow-out facilities

The following procedure is not very accurate but is sufficiently practical for use, especially where the same person always does the counting:

- a) on every transfer occasion count out 100 PL individually by dipping a hand bowl into a larger bowl containing PL. Transfer them into the plastic transport bag, or the transport tank;
- b) measure out further batches by visual comparison to the counted batch, and add them to the plastic bag or transport tank. You will quickly become able to estimate the number of PL in each small bowlful dipped from the larger bowl quite accurately;
- c) once the PL have been counted into the bags or transport tanks in batches, usually of 1 000 or 2 000, they are not normally counted again before they are stocked into the rearing facilities.

Another version of the method described above is to weigh the first batch counted [see (a) above] and use this weight alone to measure subsequent batches. However, this may cause more stress to the animals. Note that two-month old juveniles are much easier to count than PL.

## 3. Stock estimation during the grow-out period

Once the prawns have been put into a pond, it is extremely difficult to estimate growth rate or survival. Multiple seine and cast net samples seem the only reasonable method of fol-

lowing the growth rate of a crop of prawns. At least this enables a comparative estimate to be made. It is important that the method of sampling on each occasion is exactly the same (the same net; the same time of day; the same areas of the pond sampled; the same method of casting or pulling the net through the pond; and preferably the same person doing the sampling).

Even though the result may be grossly inaccurate, sampling animals from the ponds with a cast net (Annex 6, Figures 1 and 2) or a seine net on a regular basis does give you a reasonable idea of how your crop is growing. It is also a good opportunity to examine the health of the

**ANNEX 6, Figure 1**  
Freshwater prawns can be sampled with a cast net; the polythene sheeting is not a pond liner but is placed on the banks to prevent prawns escaping from the pond in the rainy season (India)



**ANNEX 6, Figure 2**  
This sampling by cast net reveals a badly eroding pond bank (Thailand)



**SOURCE:** STEPHEN SAMPATH KUMAR (TOP) **SOURCE:** MICHAEL NEW (BOTTOM)

animals. It does not, unfortunately, give you much more than a vague idea of the survival rate.

#### 4. Stock estimation when market-sized prawns are harvested

From the practical rather than the scientific point of view, there are two vitally important data which must be recorded at harvest time. One is the total drained weight of the harvest and the other is the average size of the animals harvested.

From these data the numbers of animals harvested can be estimated. Since you already have an estimate of the number of PL or juveniles stocked, you can then calculate an estimated survival rate. Together, you can use these data to assess the productivity of your pond and the efficiency of the management system you have used.

Combined with the costs of production and the market value of the product, this information enables you to calculate the overall economic performance of each pond. Although the length of the prawn [biologists usually measure them from behind the eye stalk to the tip of the tail (Annex 6, Figure 3); farmers usually measure them from the tip of the rostrum to the tip of the telson] is a more accurate form of measurement than weight, it is not so easy for you to measure, particularly as you then have to convert the measurement to weight using a calibration curve (Annex 6, Figure 4).

The weight of the animal can easily be measured on a portable scale. It will be inaccurate because of the amount of water adhering to the

ANNEX 6, Figure 3  
Measuring the length of a prawn (Brazil)



SOURCE: DEBORAH ISMAEL

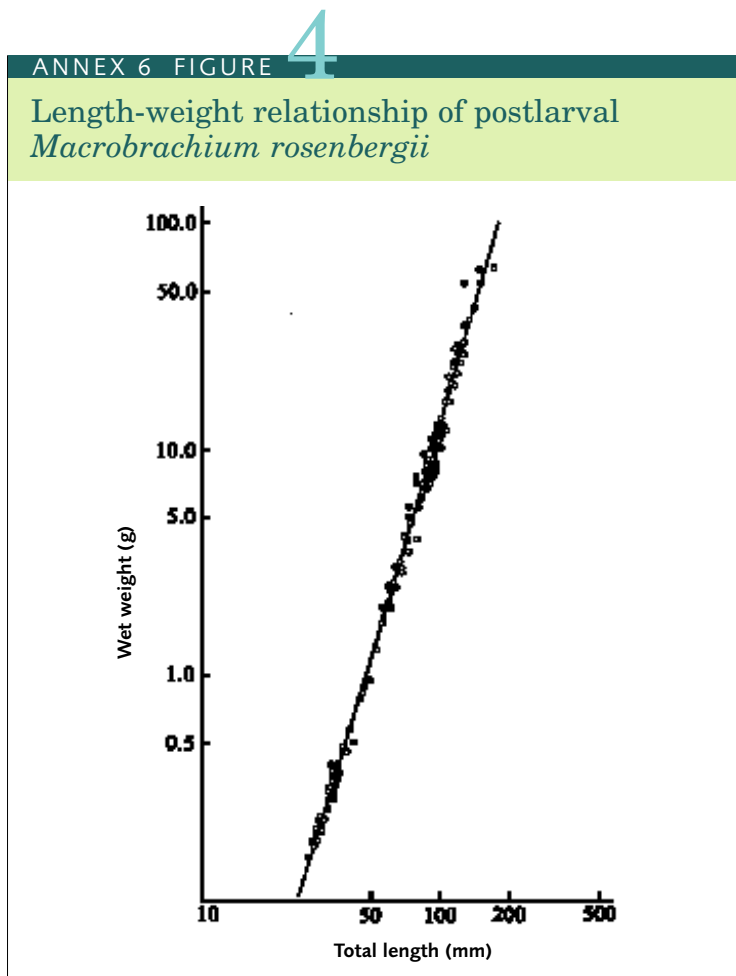

SOURCE: WICKINS (1972)

animal, particularly within the gill chambers. However, especially when the same person always does the weighing, it is possible to standardize the weighing technique and to achieve reasonable comparative accuracy.

It is suggested that you individually weigh about 250 animals for every 500 kg harvested (this is equivalent to a 2% sample of the population if the average weight is 40 g). Take the sub-sample from the total harvest by dip-netting from the holding container or cage. Do not select individual animals because this will lead to a bias towards the larger animals. Use a dip-net and weigh every prawn that you obtain in your sample.

## Seine nets

**THERE ARE VERY MANY** different types of harvesting and sampling devices used in aquaculture, including seines, gill nets, lift nets, cast nets, bag nets, traps, and barriers. The making and use of these nets and traps is described in detail in another FAO manual (FAO, 1998). The following annex deals specifically with the use of seine nets in the cull-harvesting of freshwater prawns; information from the original FAO freshwater prawn manual has been supplemented with material drawn from FAO (1998) and Valenti and New (2000).

3/8 inch (9.5 mm) polypropylene (common trade names: danaflex, nufil, ulstron) is suitable for the floater line (sometimes called the head line) and 1/2 inch (12.7 mm) polyamide (common trade names: nylon, perlon, amilan, anzalon) for the sinker (sometimes called the foot line). Nylon is soft and follows the contours of the pond, while polypropylene is light and floats, yet is stiff enough to minimize sagging. Sinker lines smaller than 1/2 inch tend to sink into the mud. Soak the ropes for 12 hours and wet-stretch and dry them to prevent twisting. Both floater and sinker lines must be 2-3 m longer than the seine itself. You will also need pulling ropes. Long seines can be handled better if each end of the floater and sinker lines is fixed to a wooden pole and the pulling rope is attached to the top and the bottom of the pole. These poles can be used to stake (moor) the seine by ramming them into the bottom of the pond.

Monofilament netting is best. Double knotted, 17 lb test netting should be used. Mesh sizes (stretched) may vary from 18-50 mm; the choice depends on the market size of prawns you wish to capture. The rostrums, claws and other appendages of prawns tend to get caught in the net, so a larger mesh size than you would use for the same size (weight) of finfish can be used for freshwater prawns. For example, a stretched mesh (Annex 7, Figure 1) size of about 40 mm will retain prawns of 45 g and above. For comparison, FAO (1998) states that a net with a stretched mesh size of this size (40 mm) retains silver carp of about 30 g, or common carp or tilapia of about 20 g. The depth of the net should be about 1.5-2.0 times the depth of the deepest water to be seined. Its length should also be at least 1.5 times the width of the pond through which it will be drawn. Monofilament of 60 lb test should be used to fix the netting to the floater and sinker lines, using a 'double clove hitch' at every third eye. Net ends should be reinforced with a heavy strand of nylon to prevent tearing. A seine net being used for harvesting prawns is illustrated in Annex 7, Figure 2 and a typical design for a seine net is shown in Annex 7, Figure 3.

Sufficient floats should be used to prevent the line sagging. If this occurs, some prawns will crawl over the net. In general, a float can support a weight (its 'floatability') equivalent to 80-90% of its volume; a single 70 mm x 40 mm egg-shaped or oval-shaped float with a hole diameter of 9 mm can support a weight of 63 g. Cylindrical plastic (PVC or polyurethane) floats, 64 mm long and 64 mm in diameter have been used on freshwater prawn seines, for example. Moulded U-shaped leads are favoured against commercial



The size of the mesh of freshwater prawn seine nets is normally measured when the net is stretched

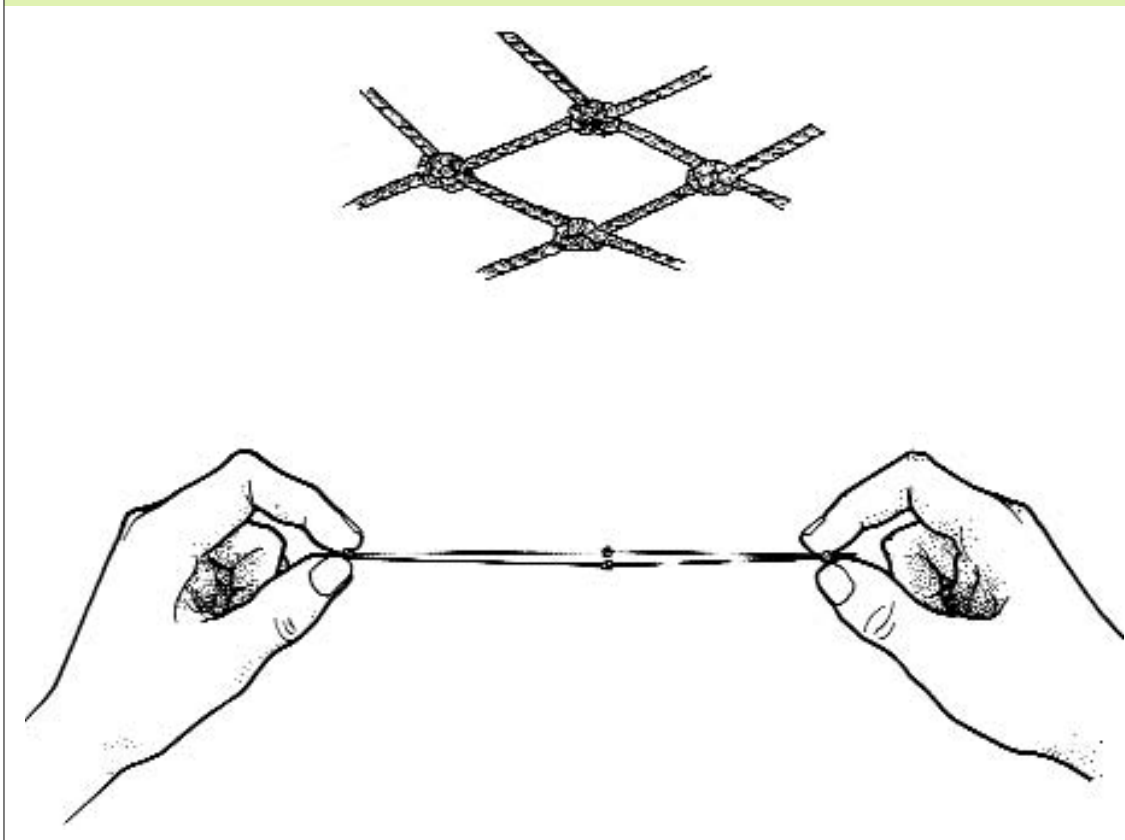

SOURCE: EMANUELA D'ANTONI

sinkers as they have a smaller cross-section. The total weight of the lead sinkers needs to be 1-1.5 times the total floatability of the floats. Leads cut to 37 mm from a 3 mm thick sheet, weighing about 60 g, hammered onto the sinkers every 28 cm are suggested for freshwater prawn seines.

Some seines used for freshwater prawns have a bag similar to that of a beach seine,

except that the top is left open and the distance between the floaters is reduced to prevent prawns from escaping over the top. A bag with floor dimensions of 15 ft x 9 ft (approximately 4.6 m x 2.7 m), tapering down to 4 ft (~1.2 m), will hold 200 kg of live prawns. Many

**ANNEX 7, Figure 2**  
Freshwater prawns (*Macrobrachium rosenbergii*) can be cull-harvested by seining (Hawaii)



SOURCE: TAKUJI FUJIMURA

seines used for harvesting freshwater prawn grow-out ponds have no bag, but a temporary catch area is made by the seine operators drawing in the sinker line as the seine is pulled towards the bank. Where prawns are to be transferred to another pond, for example from a nursery pond to a grow-out pond, the use of a bagged seine net may lessen the amount of damage to the prawns.

### ANNEX 7 FIGURE 3

#### An example of the design of a seine net

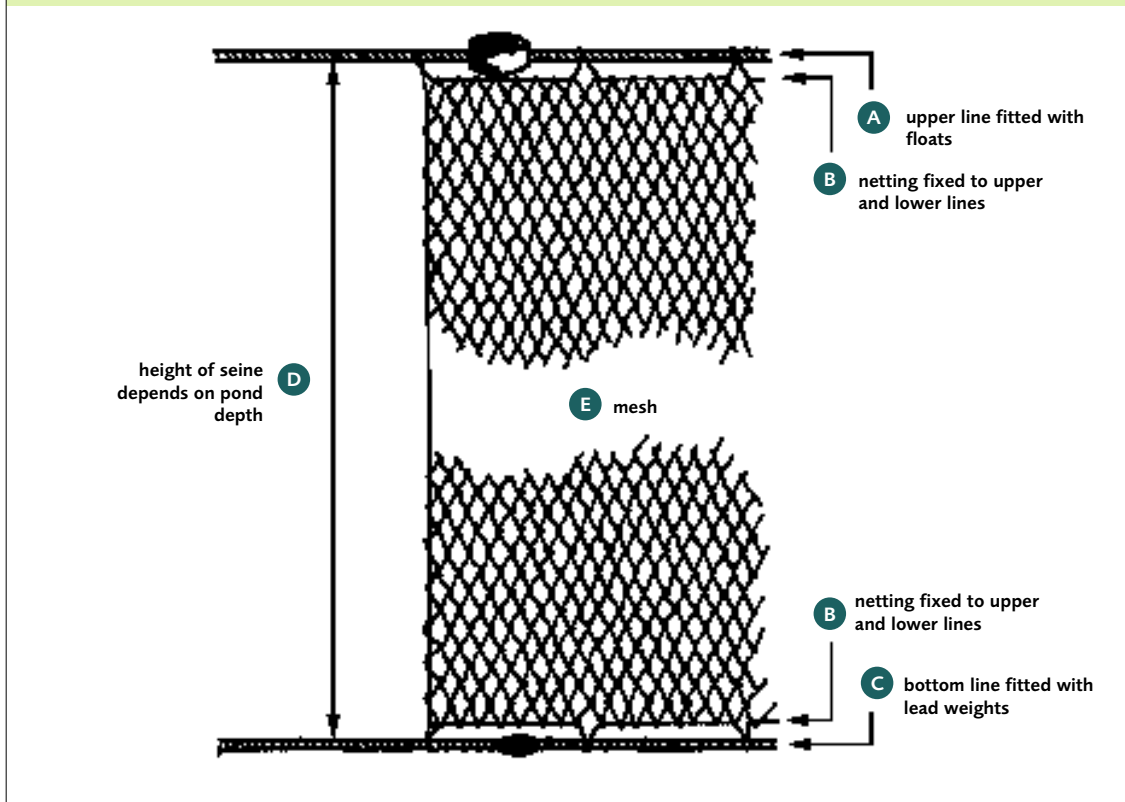

SOURCE: EMANUELA D'ANTONI

# Size management

**AS MENTIONED IN SEVERAL SECTIONS** of this manual, freshwater prawns do not grow at an even rate (Annex 8, Figure 1). This makes the management of size an essential component of the efficient husbandry that is needed to ensure their successful farming. A considerable volume of knowledge about the different (male) morphotypes which play a part in the phenomenon of uneven growth has been gained since the previous FAO manual on freshwater prawn farming was written. The topic has been reviewed in depth by Karplus, Malecha and Sagi (2000), from which the material in this annex has been derived. The main purpose of Sections 1-3 in this annex is to provide an introduction to the scientific background; it is necessary to study this to understand the phenomenon of size distribution and management. Practical advice on management contained in the main text of the manual has taken these factors into account. Section 4 of this annex provides a check-list of the various techniques which it is essential that farmers apply to get the maximum output of marketable prawns.

## 1. Major male morphological characteristics

Firstly, it is necessary to understand what is meant by the various morphotypes. Three major morphotypes have been described for sexually mature male *M. rosenbergii* (Annex 8, Figure 2). The most immediately distinctive feature is the size and colour of the claws, and the robustness of their spines:

- Blue claw males (BC) have extremely long blue claws (second pereopods) with longer and stronger spines than OC males;
- Orange claw males (OC) have golden coloured claws that are generally shorter and have shorter and less strong spines than those of BC males; and
- Small males (SM) have small, slim, almost translucent claws.

There are also a number of intermediary forms between these major morphotypes. The transition from the small male (SM) to the orange claw (OC) morphotype is gradual. The OC is therefore sometimes referred to as the strong orange claw (SOC), and an intermediate stage between these two forms, the weak orange claw male (WOC), has been recognized in research work. Another intermediate form, this time between the orange claw (OC) and the blue claw (BC) is known as the transforming orange claw (TOC); this is the last stage of the SOC male before it transforms into the BC male, as described later in this annex.

Karplus, Malecha and Sagi (2000) also describe some other external features which can be used to delineate the various morphotypes, such as the length and orientation of the spines on the claws, but these are less immediately obvious than claw colour and size. There are also a number of internal morphological and physiological differences, as well as

In *Macrobrachium rosenbergii* ponds which have not yet been harvested in any way, there are two length frequency peaks for males (the smaller ones sometimes being referred to as ‘runts’ and the larger ones as ‘bulls’) but only one peak for females

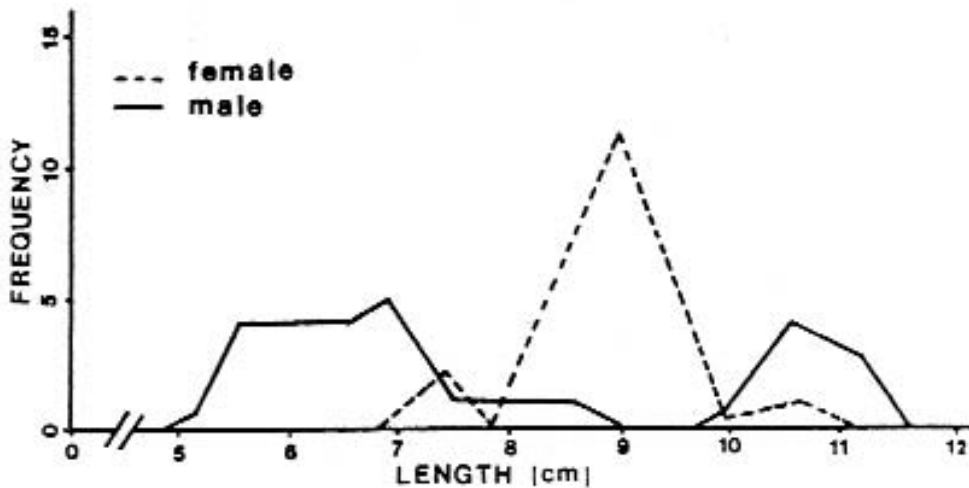

SOURCE: FUJIMURA AND OKAMOTO (1972), REPRODUCED FROM NEW AND VALENTI (2000) WITH PERMISSION FROM BLACKWELL SCIENCE

differences in moult frequency. SM have relatively large testes that both produce and store sperm. The testes of BC serve mainly as a sperm reservoirs. The three orange claw male forms (WOC, SOC and TOC) represent a series of gradual changes between SM and BC. Firstly, the abundance of mature sperm found in the testes of SM declines and almost disappears in the early OC stages. At the same time, the rate of production of spermatocytes (cells from which spermatozoa arise) increases as the SM moults into the OC phase. The OC phase is also characterized by frequent moulting. Another differential feature is the size (weight) of the midgut glands, especially the hepatopancreas. The hepatopancreas weight of the rapidly growing SOC is much greater than in all other morphotypes. The slow-growing SM and BC have the lowest relative midgut gland weight, while the WOC and the TOC males have intermediate values.

#### ANNEX 8, Figure 2

The major male morphotypes of *Macrobrachium rosenbergii* are called blue claw (BC), orange claw (OC), and small male (SM) (Israel)

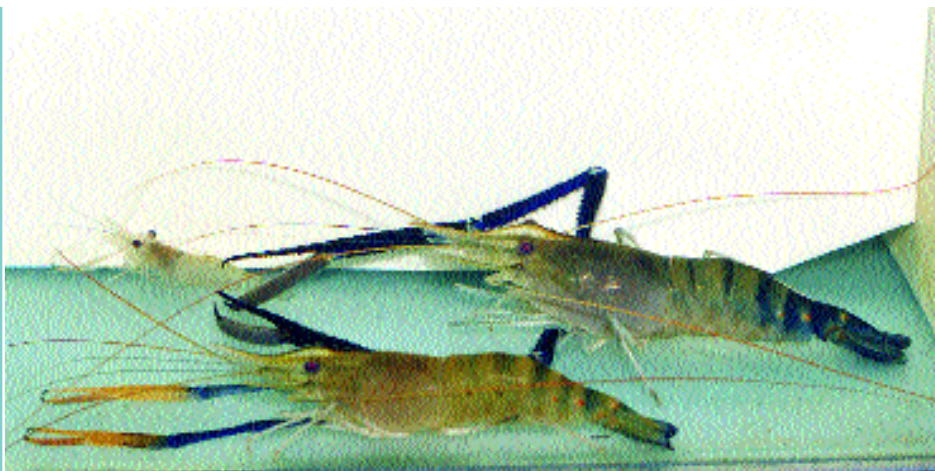

SOURCE: ASSAF BARKI, REPRODUCED FROM NEW AND VALENTI (2000) WITH PERMISSION FROM BLACKWELL SCIENCE

## 2. Behaviour

---

The behavioural characteristics of the morphotypes described above are of essential importance in the management of freshwater prawn grow-out facilities. BC males are aggressive, dominant and 'territorial', OC males are aggressive, subordinate and 'non-territorial', and SM males are submissive and 'non-territorial'.

### FIGHTING (AGONISTIC) BEHAVIOUR

The fighting behaviour of the three male morphotypes differs as males follow the developmental pathway from SM through OC to BC. There is less physical contact and fewer displays of claw position and movement occur in SM than in OC and BC. As claw size increases there is an increased risk of severe injuries caused by claws during interactions amongst OC and BC prawns. Male prawns have a hierarchical relationship. BC males are dominant over OC males which, in turn, are dominant over SM. Interactions between BC males are often only for show, with little physical contact. Those between BC and OC males involve more physical contact but BC males generally use threat displays and mere approaches in their relationships with SM. BC and OC males with equal claw size are evenly matched but a BC with larger claws than an OC, even if the OC is much larger, has an advantage. The dominance of BC over OC seems to confer priority of access to preferred areas (e.g. shaded protected crevices) but true territoriality (defending a fixed exclusive area to keep intruders out) has not yet been adequately demonstrated. However, laboratory studies have shown that competitors are evicted from the vicinity of a limiting resource, such as shelter, food, and receptive females.

### MATING BEHAVIOUR

Females approach males 2 to 3 days before their pre-mating moult. At first the female is chased away but later, after several hours of persistence, is allowed to remain near the male. About a day before the pre-mating moult the female is already totally accepted by the male, positioned below it or between its long second pair of claws. As a result of this early pair bonding, fertilisation can occur from several minutes to half an hour after moulting. It has been reported to occur up to nearly 22 hours later than the moult but this has been because researchers were pairing the males and females themselves, rather than allowing the natural bonding described above to occur. All three male morphotypes have similarly high rates of fertilising receptive females. Despite the fact that the spermatophores of SM are about half the size of those of BC males, the number of viable embryos following mating is dependent only on the female size, not on the type of male morphotype.

Males do not attack or injure the females that they have just fertilized. BC tend to guard the female for two or three days following mating, by which time the female's exoskeleton is hard enough to withstand attacks by other prawns. However, OC do not appear to groom or protect the females. There are reports of injuries inflicted by OC on females during this period (especially when more than one OC is present) but the information is, at present, conflicting. Small males have been observed to mate with females by sneaking between a receptive female and her guarding BC male. A single SM has little or no chance to gain access to a receptive female guarded by a BC male. However, SM mating can be achieved when there are three or more SM present; while the BC is chasing away some of the runts, the female remains unprotected. Occasionally, following their pre-mating moult, females have been observed with several spermatophores attached to their sperm receptacle. There is some evidence that females are more attracted (through

chemoreception) to BC and are more aggressive towards other male morphotypes. However, unfertilized females quickly lose all their eggs, which may be the reason why females that have undergone the pre-mate moult cooperate during mating with any of the male morphotypes.

### 3. Importance of population structure in freshwater prawn farming

---

The characteristics of size distribution in freshwater prawns (Annex 8, Figure 1) has been mentioned many times in this manual. This section of the annex describes how various factors affect the size distribution of the prawns in your ponds.

#### THE EFFECT OF THE SEX RATIO

The proportion of females under grow-out conditions tends to be greater than males, possibly for the following reasons:

- females may already outnumber males at stocking; and
- selective male mortality may occur in crowded pond populations.

Since the highest prices are generally obtainable for the largest animals, a preponderance of females in a population may seem to be a disadvantage at first glance. It would appear to indicate that there would be a strong incentive to rear all-male populations of prawns. However, the effect of density on average weight is more extremely pronounced in all-male, compared to all-female populations. The use of all-male populations would therefore not remove the need to manage size variation and harvesting procedures very carefully. If maximizing the total weight of prawns produced per hectare is the main goal, the rearing of all-female populations at very high densities would be sensible. However, if maximizing the income from the pond is the main goal, proper management of mixed-sex or all-male populations would be best, since the larger-sized prawns normally have the greatest unit value. Manual sexing has been done on an experimental scale but this requires extremely skilful workers and is very labour-intensive. It is likely that commercial preparations of the sex-controlling androgenic hormone to sex-reverse the broodstock used to generate monosex populations will become available in future.

#### THE EFFECT OF DENSITY

The proportions of the various male morphotypes change significantly with density (Annex 8, Figure 3). High density results in a larger proportion of SM. The frequency of the large BC males is highest at low densities. At high densities many prawns are in close contact with BC males, which inhibit their growth.

#### THE EFFECT OF UNEVEN MALE GROWTH RATE

Newly metamorphosed postlarvae are relatively even in size but size variation soon becomes noticeable. Individual prawns grow at different rates. This is known as heterogeneous individual growth (HIG). Some exceptionally fast-growing individuals (sometimes called 'jumpers') may become up to 15 times larger than the population mode within 60 days after metamorphosis, forming the leading tail of the population distribution curve. Jumpers became obvious within two weeks after metamorphosis. Slow-growing prawns (laggards) only become apparent later, about 5 weeks following metamorphosis. It has been suggested that growth suppression in laggards depends upon the presence of the larger jumpers. Male jumpers develop mainly into BC and OC males, while laggards develop mainly into small males.

Changing the stocking density has an effect on the proportion of the various morphotypes of *Macrobrachium rosenbergii*

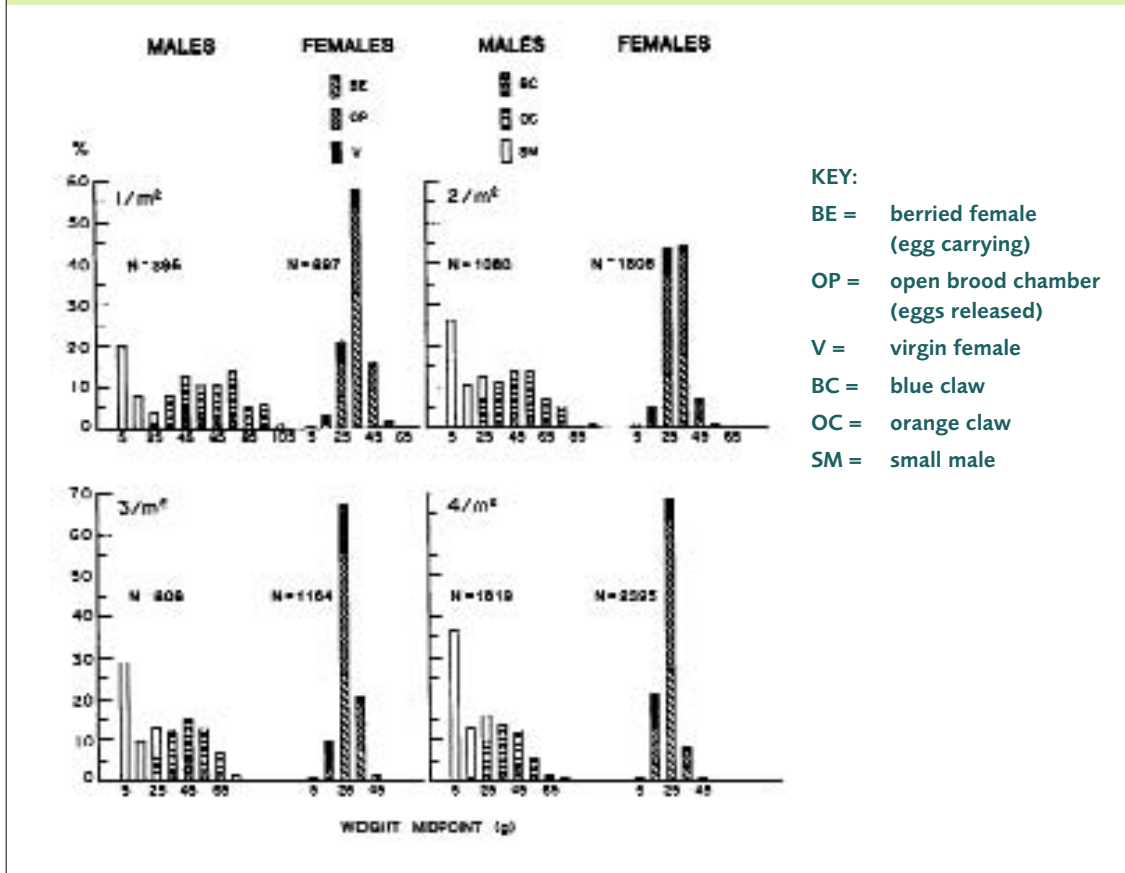

SOURCE: KARPLUS, HULATA, WOHLFARTH AND HALEVY (1986), REPRODUCED FROM NEW AND VALENTI (2000) WITH PERMISSION FROM BLACKWELL SCIENCE

Once this specific growth pattern has been established, juvenile prawns continue to show different growth patterns, even when they are isolated. Many studies have been conducted on the effects (on harvest production and average animal weight) of grading prawns into different fractions depending on size but are outside the scope of this manual to record. For further reading on this topic see the review by Karplus, Malecha and Sagi (2000). This research has provided important clues towards improved management of grow-out populations in freshwater prawn farming and forms some of the background for the comments on grading in this manual.

### THE SOCIAL CONTROL OF GROWTH

Social interactions between freshwater prawns are extremely important in regulating growth. In freshwater prawns the most important social interactions are the growth enhancement of OC males (what is known as the 'leapfrog' growth pattern) and the growth suppression of SM by BC males.

### Growth enhancement of orange claw males

The change of OC males into BC males is sometimes called a metamorphosis because the

differences between these morphotypes are so dramatic. An OC metamorphoses into a BC after it becomes larger than the largest BC in its vicinity (Annex 8, Figure 4). As a new BC male it then delays the transition of the next OC to the BC morphotype, causing it in turn to attain a larger size following its metamorphosis. The newly transformed BC is larger (sometimes much larger) than the largest BC previously present. This is known as the 'leapfrog' growth pattern, because the weight of one type of animal leaps over another.

BC males dominate OC males, regardless of their size, probably because of their larger claws. A prawn that has metamorphosed into a BC male and is larger than any other BC in its vicinity (following the 'leapfrog' growth pattern) becomes the most dominant prawn in the vicinity until it is overtaken by another prawn metamorphosing from OC to BC. The 'leapfrog' growth pattern results in the gradual descent in the social rank of existing BC males. When a new and larger BC appears on the scene, the 'social ranking' of all BC males present before that event fall.

### Growth suppression of small males

The growth of runts (SM) is stunted by the presence of BC males. Food conversion efficiency seems to be the major mechanism controlling this growth suppression in runts. Runts have poorer (higher FCR) feed efficiency when BC males are present. This seems to be governed by physical proximity; the phenomenon has not been demonstrated when these two types of prawns are separated, even when they are in the same water system and can see each other (i.e. chemoreception and sight are not factors).

As noted earlier in this annex, SM are sexually active. While they stay small they attract less aggression from dominant BC males (which are busier interacting with OC males) and are probably less vulnerable to cannibalism since they can shelter in small crevices. Being small and highly mobile, runts can find food on the bottom before being chased away by larger prawns, whether they be males or females. If BC males are removed from the population, some runts will increase their growth rate, and transform into OC males and, finally into BC males, following the normal 'leapfrog' growth pattern. This highlights the importance of regular cull-harvesting.

## 4. Managing grow-out in the light of heterogeneous individual growth (HIG)

---

Several important characteristics of freshwater prawns that affect the potential harvest from grow-out have been described above. These create various management options; a check-list of those procedures is provided below. The first three techniques have been described in the main text of this manual. The final technique (monosex culture) is a possible future development and is not part of the current manual. In grow-out management:

- there is an opportunity to improve the final harvest, both in terms of average market size and total production, by **grading**, because the prawns that are going to grow fastest become identifiable within 2-5 weeks after the PL metamorphose from larvae.
- there is an opportunity to increase the final harvest, both in terms of average market size and total production, by **cull-harvesting**. This removes the BC males, many of the OC males, and the larger females, thus encouraging small males to grow faster in the absence of dominant males (sometimes known as compensatory growth).
- there are opportunities for increasing productivity through the use of **substrates**. These provide refuges for newly moulted prawns (which increases survival) and



Orange claw (OC) and blue claw (BC) male *Macrobrachium rosenbergii* grow with a leapfrog pattern

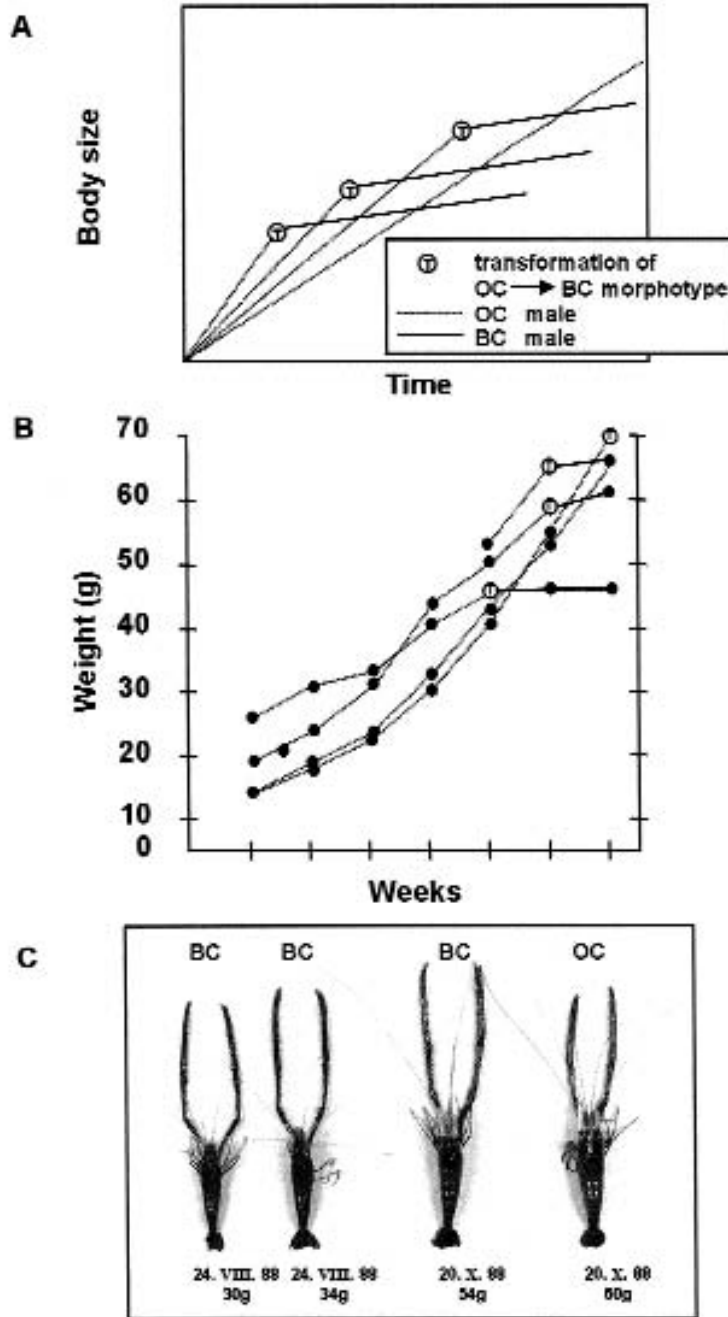

**SOURCE:** REPRODUCED WITH PERMISSION FROM BLACKWELL SCIENCE FROM KARPLUS, SAGI AND MALECHA (2000), WHERE THE ORIGINAL SOURCES OF THE THREE ILLUSTRATIONS ARE CITED

decrease the frequency of fighting (which reduces growth suppression). This results in fewer SM, more OC and BC males, and higher average harvest weights.

- the potential advantages of **monosex culture**, not only because of the differential growth rates of males and females but also because there is less HIG in females than in males, may eventually become exploitable.

Further reading on the experimental results of following these management options is provided in the review by Karplus, Malecha and Sagi (2000).

# Farm-made pond feeds

**THIS ANNEX PROVIDES** a very brief introduction to farm-made grow-out feeds and their use for freshwater prawns. Further reading on this topic is provided in New (1987) and New, Tacon and Csavas (1995).

## 1. Feed preparation

The following general instructions are for the preparation of diets, which may be fed moist or dried.

1. **Mix all your dry ingredients** (except vitamin mix, if used) thoroughly, preferably in a mechanical mixer.
2. **Add your vitamin mix**, if your formula contains one, and remix as in No. 1 above.
3. **Add any liquid ingredient** (such as fish oil) or any wet materials (such as chopped trash fish). [Note of caution: commercially processed shrimp by-products, such as shrimp meal and shrimp head meal, are very valuable from a nutritional point of view in feeds for freshwater prawns. There is no danger that such ingredients will cause disease problems (Flegel, 2001). However, the use of raw (unprocessed) shrimp or prawn wastes, such as prawn heads, may introduce viruses (e.g. WSSV) into your farmed animals. Although this may not cause any visible symptoms it may make them carriers of the disease for other crustaceans.]
4. **Remix** all your ingredients thoroughly.
5. You will now need to **add up to 30-35% of water**. The exact quantity depends on the moisture of the ingredients. You will need to add enough water to produce a very thick paste. Add water a little at a time and test the mixture. It is easy to add more water (but not possible to remove it if you add too much at first!). You can test the consistency (stickiness) of the diet by squeezing it within your clenched hand. If the 'sausage' of mixed diet (consistency of bread dough) which emerges from your fist between your first finger and your thumb is too crumbly, you need to add more water. If it runs out like a liquid, you have already added too much water!
6. **Continue mixing**. You can help to mix your ingredients thoroughly by passing the mixture through the coarse die of a meat mincer (see No. 7 below). This works well and also helps to bind the diet together.
7. You can now shape the mixed diet into small balls or discs by hand. However, it is best if you **extrude the mixed diet through a meat mincer**, this time using

**ANNEX 9, Figure 1**  
Some farmers make their own equipment for extruding farm-made feeds (Thailand); this photo shows the tray where the mixed feed is pushed into the grinder, whose die plate is at the far side (not visible)



SOURCE: HASSANAI KONGKEO

small die holes (1/8-in diameter) to produce a well-bound spaghetti-like material, which breaks easily into pellets when dried. Annex 9, Figures 1 and 2 show this process.

8. You can feed your mixed diet as it is (in a moist form) if you can use it on the same day as you make it. Alternatively, you can

stir the extruded 'spaghetti' to form 1-2 cm long pellets and **sun-dry** them for later use. Drying on a concrete surface in direct sunlight for six hours (Annex 9, Figure 3) may be sufficient to reduce the moisture content of the pellets to a level (about 10-12%) at which they can be stored without excessive deterioration. Dried feed takes less space and is much easier to transport to the pond (Annex 9, Figure 4) and to feed. A simple solar dryer (Annex 9, Figure 5) can be constructed for drying pellets during the monsoon season; however, this is difficult to use if you are producing a lot of feed. Many farms find it more feasible to choose days on which the weather is forecast to be dry to manufacture and dry their feed. Others find that the feed can be collected up from the concrete drying surface if a rain cloud approaches and then put out again when the sun returns. This sounds difficult to do but the author of this manual has observed it being done! Whatever, method you choose, it is important that the feed is dried in as short a time as possible to prevent fungal growth.

9. **Dried pellets can be stored up to 2-3 months.** You must store them in the coolest conditions possible. It is essential to keep them dry and to protect them from rats and other animals during storage.

**ANNEX 9, Figure 2**  
In this photo, freshwater prawn feed is being extruded from the die plate of a meat chopper (Thailand)



SOURCE: MICHAEL NEW

## 2. Feed formulae

Some examples of feed formulae for the pond rearing of freshwater are given in Annex 9, Tables 1-7. Please note that **these formulae are only examples**; many other feeds have been used, or are possible, depending on the availability of raw materials. These examples have been extracted from D'Abramo and New (2000), where the original references are cited. Diets 1-4 are practical feeds that have actually been used in freshwater prawn grow-out. Diets Nos. 5-12 have been used in experimental work.

**ANNEX 9, Figure 3**

Farm-made feeds need to be dried if not fed directly after manufacture; this can be done by spreading the feed out on concrete or on trays for sun-drying (Brazil)



SOURCE: DENIS LACROIX

**ANNEX 9, Figure 4**

Feed that has been extruded through a mincer and sun-dried is easy to transport to the ponds (Thailand)



SOURCE: HASSANAI KONGKEO

# 5

ANNEX 9 FIGURE

If you are only making small quantities of feed, you can construct a solar drier that will protect it from rain showers and contamination by terrestrial animals and birds, as well as decreasing the loss of some vitamins caused by exposure to UV light

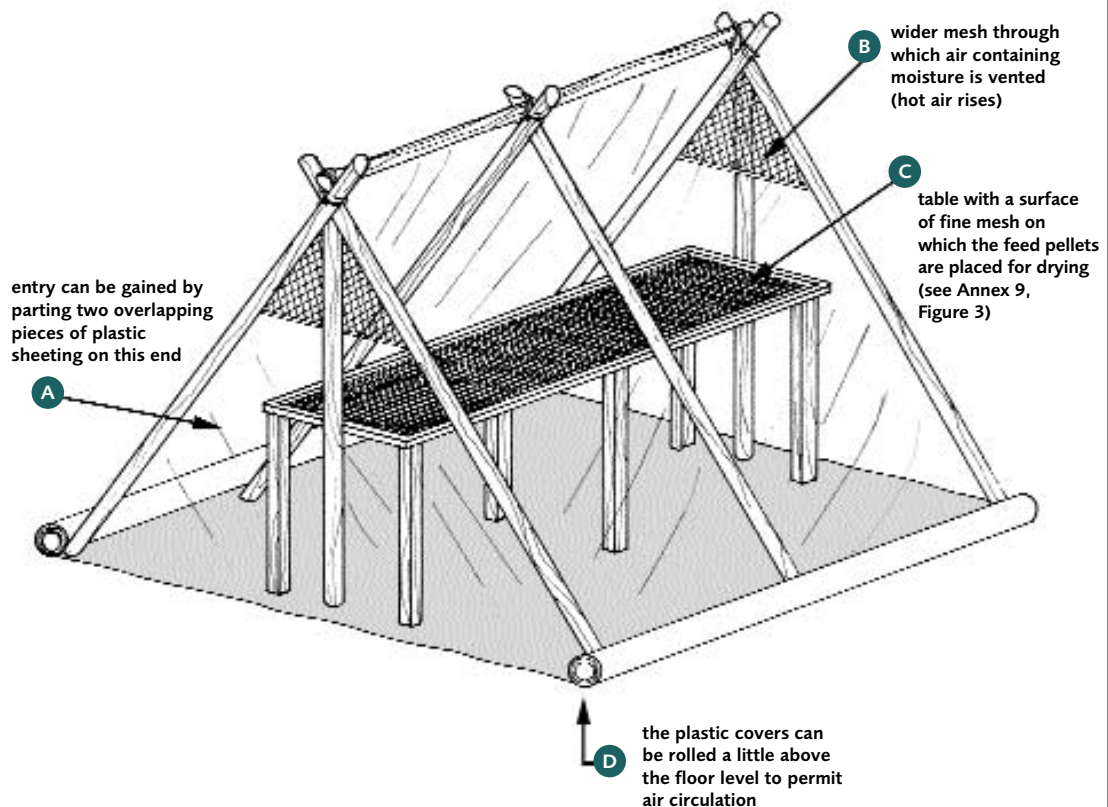

SOURCE: MANUELA D'ANTONI, DERIVED FROM FAO (1998)

ANNEX 9  
TABLE

1

Farm-made grow-out feeds No. 1 and No. 2

INGREDIENT	FEED NO. 1		FEED NO. 2	
	(kg)	(%)	(kg)	(%)
Trash fish	100.0	29.61	100.0	28.35
Soybean meal	40.0	11.84	40.0	11.34
Fish meal	20.0	5.92	10.0	2.84
Corn meal	80.0	23.70	80.0	22.68
Di-calcium phosphate	2.0	0.59	2.0	0.57
Oxytetracycline*	0.2	0.06	-	-
Vitamin and mineral mix**	0.5	0.15	0.5	0.14
Vitamin C	-	-	0.2	0.06
Broken rice (boiled)***	30.0	8.88	30.0	8.51
Chicken layers feed	50.0	14.81	60.0	17.01
Piglet feed	15.0	4.44	15.0	4.25
Shrimp shell meal	-	-	15.0	4.25
Totals (approximate)	337.7	100.00	352.7	100.00

\* PLEASE NOTE THE CAUTIONS ON THE REGULAR USE OF ANTIBIOTICS IN THE TEXT OF THIS MANUAL.

\*\* NO DETAILS AVAILABLE.

\*\*\* WEIGHT BEFORE BOILING.

ANNEX 9  
TABLE

2

Farm-made grow-out feed No. 3

INGREDIENT	(kg)	(%)
Trash fish	100	44.2
Chicken feed	60	26.6
Broken rice	30	13.3
Fish meal	20	8.8
Piglet concentrate*	15	6.6
Premix**	1	0.5
Total	226	100.0

\* COMPOSITION UNKNOWN.

\*\* A LOCALLY AVAILABLE VITAMIN MIXTURE BEING SOLD FOR FRESHWATER PRAWNS. IT WAS STATED TO CONTAIN VITAMINS A, D, C, AND E, AND AN UNSPECIFIED ANTIBIOTIC (OXYTETRACYCLINE ?) [SEE NOTE BELOW PREVIOUS TABLE]. THE MANUFACTURER SUGGESTED A VITAMIN MIX INCLUSION RATE OF 0.5-1.0%.

ANNEX 9  
TABLE

3

Farm-made grow-out feed No. 4

INGREDIENT	(%)
Fish meal*	22.5
Fresh trash fish	10.0
Rice bran	20.0
Ground rice	17.5
Sesame cake	12.5
Fish oil	2.5
Sago (palm starch)	7.0
Cane molasses	6.5
Animal grade Vitamin C**	0.5
Water	1.0
Total	100.0

\* AT LEAST 50% PROTEIN.

\*\* NO DETAILS AVAILABLE. NOTE: NO OTHER SUPPLEMENTARY VITAMINS ADDED.

**ANNEX 9** | **4** Farm-made grow-out feeds No. 5 and No. 6  
TABLE

INGREDIENT	FEED NO. 5	FEED NO. 6
	(%)	(%)
Shrimp meal	31.6	-
Fish meal	-	23.0
Soybean meal (44% crude protein)	34.4	32.6
Maize meal	14.2	17.5
Alfalfa meal	10.3	13.2
Fish oil	4.7	3.7
Di-calcium phosphate	3.1	4.9
Monosodium phosphate	0.7	4.1
Premix*	0.4	0.4
Iodized salt	0.5	0.5
Binder*	0.1	0.1
<b>Totals</b>	<b>100.0</b>	<b>100.0</b>

\* NO DETAILS AVAILABLE.

**ANNEX 9** | **5** Farm-made grow-out feeds No. 7 and No. 8  
TABLE

INGREDIENT	FEED NO. 7	FEED NO. 8
	(%)	(%)
Fish meal	20.0	-
Shrimp head meal	-	30.0
Soybean meal	9.0	4.0
Rice bran	45.0	35.0
Coconut oil cake	20.0	20.0
Tapioca (cassava starch)	5.0	9.0
Pfizer premix A*	1.0	1.0
Agar	-	1.0
<b>Totals</b>	<b>100.0</b>	<b>100.0</b>

\* NO DETAILS AVAILABLE.

**ANNEX 9** | **6** Farm-made grow-out feeds No. 9 and No. 10  
TABLE

INGREDIENT	FEED NO. 9	FEED NO. 10
	(%)	(%)
Soybean meal (44% CP)	22.4	20.7
Fish meal	20.0	20.0
Maize meal	18.6	6.5
Dried yeast	10.0	10.0
Wheat meal	10.0	10.0
Wheat bran	-	8.8
Grass meal ( <i>Bracharia purpurescens</i> )	12.7	15.0
Di-calcium phosphate	3.8	3.4
Lime (calcite*)	0.1	0.4
Fish oil	1.4	4.3
Premix**	0.5	0.4
Iodized salt	0.5	0.5
<b>Totals</b>	<b>100.0</b>	<b>100.0</b>

\* CRYSTALLINE CaCO<sub>3</sub>  
\*\* NO DETAILS AVAILABLE.

**ANNEX 9** | **7** Farm-made grow-out feeds No. 11 and No. 12  
TABLE

INGREDIENT	FEED NO. 11	FEED NO. 12
	(%)	(%)
Fish oil	3.0	3.0
Shrimp meal	25.0	10.0
Fish meal	10.0	4.0
Peanut meal (groundnut)	5.0	2.0
Soybean meal	5.0	2.0
Broken rice	25.5	39.0
Rice bran	25.5	39.0
Guar gum	1.0	1.0
<b>Totals</b>	<b>100.0</b>	<b>100.0</b>

NOTE: NO VITAMIN OR MINERAL MIX

# Basic code for introductions

**ANNEX IS DERIVED**, with acknowledgements, from part II of a draft framework for the responsible use of introduced species that was prepared for EIFAC by Bartley, Subasinghe and Coates (1999).

The basic code for introductions applies to the intentional movement of aquatic species in fisheries, biological control, aquaculture, and for research. Therefore, someone, some organization, some private business, or some government agency (referred to below as ‘the entity’) must knowingly engage in the act of transporting the species. Guidelines and policy concerning species introduced inadvertently through ballast water or on ship’s hulls are addressed elsewhere, for example by the International Maritime Organization. Development projects that involve geographic changes, such as river diversion, dredging of canals to connect distinct water bodies, etc. also may involve the subsequent introduction of exotic species and therefore this framework could also be used in the review and evaluation of those projects.

The basic code contains the requirements that:

- i) the entity moving an exotic species develop a **proposal**, that would include location of facility, planned use, passport information, and source of the exotic species;
- ii) an independent **review** that evaluates the proposal and the impacts and risk/benefits of the proposed introduction, e.g. pathogens, ecological requirements/interactions, genetic concerns, socio-economic concerns, and local species most affected, would be evaluated;
- iii) **advice and comment** are communicated among the proposers, evaluators and decision makers and the independent review advises to either accept, refine, or reject the proposal so that all parties understand the basis for any decision or action, thus proposals can be refined and review panel can request additional information on which to make their recommendation;
- iv) if approval to introduce a species is granted, **quarantine, containment, monitoring, and reporting programmes** are implemented; and
- v) the **ongoing practice** of importing the (formerly) exotic species becomes subject to review and inspection that check the general condition of the shipments, e.g. checking that no pathogens are present, that the correct species is being shipped, etc.

The Code is general and can be adapted to specific circumstances and resource availability, but it should not lose any of the above requirements nor should it lose the rigour at



which the requirements are applied. For example, a regulatory agency may require a proposal to contain a first evaluation of the risk/benefits and this evaluation would then be forwarded to an **independent review or advisory panel**; or the advisory panel could make the first evaluation of a proposal. Similarly, States may require quarantine procedures to be explicitly described in the proposal before approval is granted.

# Glossary of terms, abbreviations and conversions

## Terms

---

**THE FIRST SECTION OF THIS GLOSSARY** defines unfamiliar terms used in this manual. The definitions are intended to make the terms understandable to the novice rather than to the biologist.

<b>Abdomen:</b>	commonly referred to as the ‘tail’ of prawns, this is the area containing segments from which the swimming appendages originate. See Table 1 of the main text for details.
<b>Agonistic:</b>	fighting, combative behaviour.
<b>Artemia:</b>	scientific name for brine shrimp.
<b>Bacteria:</b>	microscopic single-cell organisms of a kind which can cause disease.
<b>Bank:</b>	the elevated rim of a pond. Also called embankment, dyke (dike), berm or bund.
<b>Batch culture:</b>	a system of rearing prawns involving the total harvest, by seining or draining or both, at a certain interval after stocking (see Box 15). The ponds are then drained before re-stocking.
<b>Benthic:</b>	organisms living on the bottom of the pond; opposite of planktonic.
<b>Berm:</b>	see Bank.
<b>Berried:</b>	egg carrying.
<b>Brine shrimp:</b>	a small crustacean whose larvae are used to feed larval prawns.
<b>Brood chamber:</b>	an area formed beneath the abdomen of the mature female by the expansion of the pleura, in which the fertilized eggs are carried before hatching. In this area the eggs are oxygenated by movement of the pleopods.
<b>BSE:</b>	bovine spongiform encephalopathy, a serious disease of ruminants, which seems to be associated with the incidence of a similar disease in humans. Colloquially known as mad cow disease.
<b>Buffer:</b>	a substance or substances which resist or counteract changes in the acidity or alkalinity of water.
<b>Bund:</b>	see Bank.

<b>Carapace:</b>	a dorsal cover which obscures the division between the true head (cephalon) and the thorax (jointly known as the cephalothorax) of prawns.
<b>Caridean:</b>	a crustacean which belongs to one of the two main groups (infraorders; sections) which form the suborder Natantia of the order Decapoda. The group is called the Caridea; thus these crustaceans are known as carideans. Within this infraorder (Caridea) the family of main importance to aquaculture is the Palaemonidae, which, in addition to containing some marine prawns (e.g. <i>Palaemon serratus</i> ), contains most of the commonly farmed freshwater prawns belonging to the genus <i>Macrobrachium</i> (e.g. <i>Macrobrachium amazonicum</i> , <i>M. malcolmsonii</i> , <i>M. nipponense</i> and <i>M. rosenbergii</i> ).
<b>Cephalon:</b>	part of the area under the carapace. Contains the segments from which the eyes, antennae, and three other pairs of appendages originate. See Table 1 of the main text for details.
<b>Chela:</b>	claw
<b>Chelae:</b>	plural of chela.
<b>Chelating:</b>	the action of a chelator.
<b>Chelator:</b>	a substance which binds ions and holds them longer in suspension, thus (for example) making nutrients available to algae longer. Chelators also sequester (bind) heavy metals that may have entered the system from exterior sources, thus reducing the toxicity that they may have for prawn larvae. In greenwater systems both chelating actions would be valuable; in clearwater systems, it is the reduction of toxicity that is the most likely to cause the beneficial effect.
<b>Cheliped:</b>	literally a leg with a claw on it. Strictly, all the pereopods have claws on them and are therefore chelipeds. However, only on the first two pairs are the claws (chelae) formed into pincers. In practice, the word cheliped is often only applied to the legs with the largest pincers (in freshwater prawns these are the longest legs, the second pereopods).
<b>Clearwater:</b>	larval rearing water which does not contain green planktonic algae.
<b>Combined system of culture:</b>	an intermediate form of culture between batch and continuous culture, on which the grow-out and harvesting sections of this manual are based (see Box 15).
<b>Continuous culture:</b>	a system of rearing prawns in ponds which involves continuous pond operation (see Box 15). Ponds are not regularly drained for harvesting, nor completely harvested. The larger animals are regularly removed by seine net for marketing, leaving the smaller ones to grow on. The ponds are regularly restocked with postlarvae or juveniles.

<b>Count:</b>	this term, used by shrimp buyers, refers to the number of prawns or prawn tails per unit weight. When using this term, it is important to state whether shell-on/head-on, shell-on tails or peeled tails are being described.
<b>Crustacea:</b>	group of animals including shrimp and prawns, lobsters, and crabs.
<b>Decapsulation:</b>	the removal of the hard outer layer (shell) of <i>Artemia</i> cysts.
<b>Dike:</b>	see Bank.
<b>DO<sub>2</sub>:</b>	dissolved oxygen content (of water). Sometimes reported as ppm and sometimes as percent of saturation level. In this manual, ppm has been used.
<b>Dorsal:</b>	upper.
<b>Dyke:</b>	see Bank.
<b>Endopod:</b>	anatomical term referring to the inner part of the end of an appendage.
<b>Epilimnion:</b>	upper layer of water in a stratified lake or reservoir.
<b>Exopod:</b>	anatomical term referring to the outer part of the end of an appendage.
<b>Exoskeleton:</b>	the outer hard coat of crustaceans, often referred to as the shell.
<b>Exuvia:</b>	the cast shell (exoskeleton) after moulting.
<b>Feed Conversion Efficiency (FCE):</b>	the amount of food necessary to produce one unit weight (wet) of prawns. For example, if a pond produces 1 250 kg of prawns and 3 200 kg of food were used during the rearing period, the feed conversion efficiency is: $FCE = 3\ 200 \div 1\ 250 = 2.56$ . It follows, therefore, that the lower the FCE is, the better the efficiency (of conversion into final product) of the food is. The FCE of wet feeds will be much higher than that of dry feeds because of the difference in moisture content. To directly compare two feeds with different moisture contents, it is necessary to convert the different feed conversion efficiencies to a standard moisture content or to bring the relative cost of the feeds into consideration. The latter option is more meaningful. For example, let us suppose that Feed A has an FCE of 2.8 and a cost of US\$ 492/mt. On the other hand, Feed B has an FCE of 6.9 and a cost of US\$ 215/mt. Which is the 'better' feed from the farmers' point of view? To produce one ton of prawn using Feed A would cost US\$ 492 x 2.8 = US\$ 1 377.60; using Feed B it would cost US\$ 215 x 6.9 = US\$ 1 483.50. Feed A is therefore cheaper to use, even though its unit price is more than twice than that of Feed B.
<b>Feed Conversion Ratio:</b>	this is the same as feed conversion efficiency, except that it is written as a ratio (FCR), i.e. a feed conversion efficiency of 2.8 is written as a feed conversion ratio of 2.8:1. This means 2.8 kg of food is necessary to produce 1 kg of prawns live weight. The two terms are frequently used synonymously. For example, you may often see an expression such as 'the FCE of the diet was 2.8:1'.

<b>Genital pores:</b>	the openings of the reproductive organs to the exterior of the animal. In males they are between the fifth pair of pereopods and in females between the third pair of pereopods.
<b>Gill chamber:</b>	the area at the sides of the 'head' of the prawn that contains the gills through which the prawn takes oxygen from the water and releases carbon dioxide during respiration.
<b>Greenwater:</b>	larval rearing water with an induced density of green planktonic algae.
<b>Head:</b>	a common term that includes both the true head (cephalon) and the thorax area, which are below the carapace.
<b>Heterogeneous:</b>	different; diverse.
<b>HIG:</b>	heterogeneous individual growth.
<b>H<sub>2</sub>S:</b>	hydrogen sulphide.
<b>Juvenile:</b>	this is a very indefinite term and could be used to refer to any prawn that is no longer a larva but is not yet sexually mature. However, in farming, this term is usually used to refer to animals which are larger (older) than PL when used for stocking grow-out ponds (or open waters), that is prawns up to about 3 g in weight. The main text of the manual contains details of the rearing of PL to juvenile sizes in nursery facilities. In their natural habitat, freshwater prawns at this stage can move against strong currents, climb rapids, and move across wet areas to other waters. They are very hardy by this time.
<b>Lab-lab:</b>	a term which originated in the Philippines, that refers to the complex of blue-green algae, diatoms, bacteria and various animals that forms on the bottom or other surfaces of ponds and tanks.
<b>Larva:</b>	singular of larvae.
<b>Larvae:</b>	animals that have hatched from eggs but have not yet metamorphosed into postlarvae. They require brackishwater and swim upside down, tail up and backwards. Their anatomy (form) is also different from juveniles or adults.
<b>Metamorphosis:</b>	the process of transformation by which a larva becomes a post-larva and takes on the miniature appearance and the behaviour of an adult.
<b>Moult:</b>	to cast the shell.
<b>Orbit:</b>	eye socket.
<b>Ovigerous:</b>	having ripe ovaries.
<b>Penaeid:</b>	a crustacean which belongs to one of the two main groups (infra-orders; sections) which form the suborder Natantia of the order Decapoda. This group is called the Penaeidea; thus these crustaceans are commonly known as penaeids. Within this infraorder

(Penaeidea) the family Penaeidae contains most of the commonly farmed marine shrimp (e.g. *Litopenaeus (Penaeus) vannamei*, *L. stylirostris*, *Penaeus monodon*, *P. semisulcatus*, *Fenneropenaeus merguensis*, *F. chinensis*, *Marsupenaeus japonicus*, *Farfantepenaeus aztecus* and *Metapenaeus* spp.).

- Pereiopods:** an anatomical term, referring to the five pairs of legs below the thorax. The first two pairs are used for catching food, in mating, and in agonistic behaviour; the last three pairs are 'walking legs'.
- PL:** an abbreviation for postlarva, postlarvae
- Planktonic:** living organisms (mainly microscopic) that are found within the body of the water (in other words, the opposite of benthic).
- Pleopods:** an anatomical term, referring to the five pairs of legs below the abdomen (sometimes called the 'tail', when prawns are headed before sale) of the prawn, which are used mainly for swimming (swimmerets).
- Pleura:** an anatomical term, referring to the sides of the abdominal segments.
- Postlarva:** singular of postlarvae (PL).
- Postlarvae:** a term (PL) usually applied to animals from immediately after metamorphosis from the larval stage up to about 10-20 days later. This term and the word 'juvenile' are applied very loosely and sometimes synonymously. Postlarval freshwater prawns swim and behave like adult prawns and, as they age, cling to or crawl on surfaces rather than swim freely in the body of the water.
- ppm:** parts per million. A unit of chemical measurement used for reporting the levels of trace materials (e.g. oxygen dissolved in water) or of an additive (e.g. active chlorine). It is equivalent to 1 ml/m<sup>3</sup>, 1 g/mt, or 1 mg/litre, for example. Where this manual prescribes the addition of a substance at a certain level, the actual amount to add can be calculated as follows. Say that you are recommended provide 50 ppm of substance X in a container (e.g. a tank). Let us suppose that the volume of water in the tank that you want to dose is 250 L. The expression 50 ppm (parts per million) means 50 parts of substance X to every 1 million parts of water (e.g. 50 ml of substance X in 1 million ml of water). As 250 L = 250 000 ml, the amount of substance X (which may be measured in ml or g) to add is:  $50 \times 250\,000 \div 1\,000\,000 = 12.5$  ml (or g).
- ppt:** parts per thousand. A unit of measurement usually applied to salinity. Also written in other documents as ‰. The salinity of full seawater varies but is often around 35 ppt (35‰). The water in freshwater prawn (*Macrobrachium rosenbergii*) larval rearing tanks is kept at 12 ppt (12‰).
- Prophylactic:** a medicine or course of action which tends to prevent disease.
- Protozoa:** a microscopic (usually single-celled) animal.

<b>Puddling:</b>	breaking the structure of the soil before the pond is filled. This is achieved by saturating the soil at the bottom of the pond; allowing the water to soak into the soil; and hoeing or ploughing it. The amount of water necessary to saturate the soil is roughly 200-300 mm (2 000-3 000 m <sup>3</sup> /ha).
<b>Rostrum:</b>	anatomical term, referring to the sharp 'beak' which extends from the head of prawns.
<b>Salinity:</b>	see ppt.
<b>Sequester:</b>	bind (see chelator).
<b>Sessile:</b>	not on stalks (applies to larval eyes in the first larval stage).
<b>Substrate:</b>	something which provides extra shelter in a tank or pond, such as nylon screens or nets, pipes, branches, etc.
<b>Supernatant:</b>	the clear liquid after a precipitate has settled.
<b>Swimmerets:</b>	synonym for pleopods.
<b>Tail:</b>	a common term referring to the abdomen, or rear part of prawns.
<b>Telson:</b>	anatomical term, referring to the pointed central projection of the last abdominal segment of prawns. The telson and the uropods together form the 'tail fan' of prawns (and other crustacea).
<b>Thorax:</b>	part of the area under the carapace. Contains the segments from which eight appendages originate. See Table 1 of the main text for details.
<b>Uropod:</b>	anatomical term, referring to two rigid structures that appear on the final abdominal segment at the sides of the telson.
<b>Ventral:</b>	lower.
<b>Walking legs:</b>	synonym for the 3 <sup>rd</sup> , 4 <sup>th</sup> and 5 <sup>th</sup> pereopods.

## Abbreviations

---

**NOT ALL OF THE FOLLOWING** abbreviations have been used in this manual. However, they are provided to help you when you read other documents.

<	less than
>	greater than
<b>n.a.</b>	not analysed or not available
<b>µm</b>	micron
<b>mm</b>	millimetre
<b>cm</b>	centimetre
<b>m</b>	metre
<b>km</b>	kilometre

<b>inch</b>	inch
<b>ft</b>	foot
<b>yd</b>	yard
<b>mi</b>	mile
<b>ft<sup>2</sup></b>	square foot
<b>yd<sup>2</sup></b>	square yard
<b>mi<sup>2</sup></b>	square mile
<b>m<sup>2</sup></b>	square metre
<b>ha</b>	hectare
<b>km<sup>2</sup></b>	square kilometre
<b>cc</b>	cubic centimetre (= ml)
<b>m<sup>3</sup></b>	cubic metre
<b>ft<sup>3</sup></b>	cubic foot
<b>yd<sup>3</sup></b>	cubic yard
<b>µl</b>	microlitre
<b>ml</b>	millilitre (= cc)
<b>L</b>	litre
<b>µg</b>	microgram
<b>mg</b>	milligram (milligramme)
<b>g</b>	gram (gramme)
<b>kg</b>	kilogram (kilogramme)
<b>mt</b>	metric ton (1 000 kg) [also written as tonne]
<b>oz</b>	ounce
<b>lb</b>	pound
<b>cwt</b>	hundredweight [value differs in UK ('Imperial') and US units - see weight conversions]
<b>t</b>	ton [value differs in UK ('Imperial') and US units - see weight conversions]
<b>psi</b>	pounds per square inch
<b>GPM</b>	('Imperial' = UK) gallons per minute
<b>MGD</b>	million ('Imperial' = UK) gallons per day
<b>CFM</b>	cubic feet per minute
<b>ppt</b>	parts per thousand (‰)
<b>ppm</b>	parts per million
<b>ppb</b>	parts per billion (thousand million)
<b>min</b>	minute
<b>hr</b>	hour
<b>kWhr</b>	kilowatt-hour



## Conversions

---

**THIS SECTION OF THE ANNEX** should be used in conjunction with the abbreviations section. Please note that the words gallon and ton have different values depending on whether the source of the text you are reading is 'British' or 'American' in origin.

### LENGTH:

---

<b>1 <math>\mu\text{m}</math></b>	0.001 mm = 0.000001 m
<b>1 mm</b>	0.001 m = 1 000 $\mu\text{m}$ = 0.0394 inch
<b>1 cm</b>	0.01 m = 10 mm = 0.394 inch
<b>1 m</b>	1 000 000 $\mu\text{m}$ = 1 000 mm = 100 cm = 0.001 km = 39.4 inch = 3.28 ft = 1.093 yd
<b>1 km</b>	1 000 m = 1 093 yd = 0.621 mi
<b>1 inch</b>	25.38 mm = 2.54 cm
<b>1 ft</b>	12 inch = 0.305 m
<b>1 yd</b>	3 ft = 0.914 m
<b>1 mi</b>	1 760 yd = 1.609 km

### WEIGHT:

---

<b>1 <math>\mu\text{g}</math></b>	0.001 mg = 0.000001 g
<b>1 mg</b>	0.001 g = 1 000 $\mu\text{g}$
<b>1 g</b>	1 000 000 $\mu\text{g}$ = 1 000 mg = 0.001 kg = 0.0353 oz
<b>1 kg</b>	1 000 g = 2.205 lb
<b>1 mt</b>	1 000 kg = 1 000 000 g = 0.9842 UK t = 1.102 US t
<b>1 oz</b>	28.349 g
<b>1 lb</b>	16 oz = 453.59 g
<b>1 UK cwt</b>	112 lb = 50.80 kg
<b>1 US cwt</b>	100 lb = 45.36 kg
<b>1 UK t</b>	20 UK cwt = 2 240 lb
<b>1 US t</b>	20 US cwt = 2 000 lb
<b>1 UK t</b>	1.016 mt = 1.12 US t

### VOLUME:

---

<b>1 <math>\mu\text{l}</math></b>	0.001 ml = 0.000001 L
<b>1 ml</b>	0.001 L = 1 000 $\mu\text{l}$ = 1 cc
<b>1 L</b>	1 000 000 $\mu\text{l}$ = 1 000 ml = 0.220 UK gallon = 0.264 US gallon
<b>1 m<sup>3</sup></b>	1 000 L = 35.315 ft <sup>3</sup> = 1.308 yd <sup>3</sup> = 219.97 UK gallons = 264.16 US gallons
<b>1 ft<sup>3</sup></b>	0.02832 m <sup>3</sup> = 6.229 UK gallons = 28.316 L
<b>1 UK gallon</b>	4.546 L = 1.2009 US gallons
<b>1 US gallon</b>	3.785 L = 0.833 UK gallon
<b>1 MGD</b>	694.44 GPM = 3.157 m <sup>3</sup> /min = 3 157 L/min

### CONCENTRATION - DISSOLVING SOLIDS IN LIQUIDS:

---

<b>1 %</b>	1 g in 100 ml
<b>1 ppt</b>	1 g in 1 000 ml = 1 g in 1 L = 1 g/L = 0.1%
<b>1 ppm</b>	1 g in 1 000 000 ml = 1 g in 1 000 L = 1 mg/L = 1 µg/g
<b>1 ppb</b>	1 g in 1 000 000 000 ml = 1 g in 1 000 000 L = 0.001 ppm = 0.001 mg/L

### CONCENTRATION - DILUTION OF LIQUIDS IN LIQUIDS:

---

<b>1 %</b>	1 ml in 100 ml
<b>1 ppt</b>	1 ml in 1 000 ml = 1 ml in 1 L = 1 ml/L = 0.1%
<b>1 ppm</b>	1 ml in 1 000 000 ml = 1 ml in 1 000 L = 1 µl/L
<b>1 ppb</b>	1 ml in 1 000 000 000 ml = 1 ml in 1 000 000 L = 0.001 ppm = 0.001 ml/L

### AREA:

---

<b>1 m<sup>2</sup></b>	10.764 ft <sup>2</sup> = 1.196 yd <sup>2</sup>
<b>1 ha</b>	10 000 m <sup>2</sup> = 100 ares = 2.471 acres
<b>1 km<sup>2</sup></b>	100 ha = 0.386 mi <sup>2</sup>
<b>1 ft<sup>2</sup></b>	0.0929 m <sup>2</sup>
<b>1 yd<sup>2</sup></b>	9 ft <sup>2</sup> = 0.836 m <sup>2</sup>
<b>1 acre</b>	4 840 yd <sup>2</sup> = 0.405 ha
<b>1 mi<sup>2</sup></b>	640 acres = 2.59 km <sup>2</sup>

### TEMPERATURE:

---

<b>°F</b>	$(9 \div 5 \times ^\circ\text{C}) + 32$
<b>°C</b>	$(^\circ\text{F} - 32) \times 5 \div 9$

### PRESSURE:

---

<b>1 psi</b>	70.307 g/cm <sup>2</sup>
--------------	--------------------------

## Scientific units

---

Scientists have a different way of writing some of the units described in this glossary. They use what is called the Système International (SI). The units are referred to as SI units. For example: 1 ppt, which can be written as 1 g/L (see concentration above) is written as 1 g L<sup>-1</sup> in scientific journals. 1 g/kg is written as 1 g kg<sup>-1</sup>. 12 mg/kg would be written as 12 mg kg<sup>-1</sup>. 95 µg/kg would be written as 95 µg kg<sup>-1</sup>. A stocking density of 11 kg/m<sup>3</sup> would be written as 11 kg m<sup>-3</sup>. This system of standardisation is not normally used in commercial aquaculture hatcheries and grow-out units and has therefore not been used in this manual. More information about this topic can be found on the internet by searching for SI Units (e.g. [www.ashree.org/book/siguide.htm](http://www.ashree.org/book/siguide.htm))

# Financial considerations

**SOME COMMENTS ON THE NECESSITY** of keeping proper farm records have been made in several places in this manual. Without such records you cannot be sure whether your management is successful or not. In addition, you cannot forecast what future resource requirements or income may be, or estimate what the effect of changes in management or market opportunities could be.

The details of economics and business management are beyond the scope of this manual. However, information on this topic, in relation to freshwater prawn culture, can be found in Rhodes (2000). In addition, an FAO manual on simple economics and farm bookkeeping is available (FAO 1992a).

# Acknowledgements

**THE AUTHOR WOULD LIKE TO THANK** the Fisheries Department of the Food and Agriculture Organization of the United Nations for suggesting and sponsoring the preparation of this manual. My personal thanks go to all those who provided information on modern culture techniques during the preparation of a recent book, whose contributions were acknowledged earlier (New and Valenti 2000). The existence of this book helped me prepare the current manual and I am grateful to Blackwell Science for allowing me to reproduce some of its illustrations.

Many friends and colleagues kindly reviewed parts of the manual, namely Claude Boyd (Chapter 2), Eudes Correia (Chapter 4), Lou D'Abramo (Table 19), Bill Daniels (Chapter 3 and parts of Chapter 4), Jean Dhont and Chris Dinneweth (Part of Section 4.2 and Annex 4), Deborah Ismael (Chapter 1), Ken Johnson (Parts of Sections 4.2 and 6.4), Ilan Karplus (Annex 8), Hassanai Kongkeo (Chapter 6), Spencer Malecha (Annex 8), James Muir (Chapter 2), Harold Phillips (Chapters 7 and 8), Patrick Sorgeloos (Part of Section 4.2 and Annex 4), James Tidwell (Part of Section 6.2), Wagner Valenti (Chapters 4, 5 and 6) and Sergio Zimmermann (Part of Section 6.2). I am grateful to Joanne Morgante, who was responsible for the final layout and production stages of the publication, and Emanuela D'Antoni, who was responsible for the artwork. Special thanks also go to the many colleagues who provided photographs specifically for this manual, whose names appear beneath the relevant illustrations. I would like to extend my gratitude to the FAO staff who contributed specific ideas, comments and other inputs to this manual; these included Jiansan Jia, Devin Bartley, Rohana Subasinghe, Erhard Ruckes, Ulf Wijkstrom, Jean Collins, Adele Crispoldi-Hotta, Mairi Page and Rine Sola.

Finally, I wish to thank three friends who have influenced my work with *Macrobrachium*. The first is Somsak Singholka who was my colleague in Thailand in 1979-1981: he co-authored the original FAO manual with me and has remained a close friend ever since. Secondly, I much appreciate the help of Mario Pedini, who stimulated the production of the original manual: his meticulous review considerably improved the draft. Finally, I owe continuing gratitude to the late Takuji Fujimura, a pioneer of freshwater prawn farming, who taught me and many others so much. I have reproduced Fuji's beautiful photographs of the larval stages of *Macrobrachium rosenbergii* again in this new manual.

# References

- Alston, D.E. & Sampaio, C.M.S.** 2000. Nursery systems and management. In M.B. New & W.C. Valenti, eds. *Freshwater prawn culture: the farming of *Macrobrachium rosenbergii**, pp. 112-125. Oxford, England, Blackwell Science.
- Anonymous.** 2001a. Farm-made aquafeed unit launched. *INFOFISH International*, 2/2001:38.
- Anonymous.** 2001b. CPF's meatier strain of *Macrobrachium rosenbergii*. *Asian Aquaculture Magazine*, September/October 2001:10-11.
- Bartley, D.M., Subasinghe, R. & Coates, D.** 1996. *Draft framework for the responsible use of introduced species*. EIFAC Publication EIFAC/XIX/96/Inf. 8. Rome, FAO.
- Boyd, C.E.** 1979. *Water quality in warmwater fish ponds*. Auburn, Alabama, USA, Auburn University Agricultural Experiment Station.
- Boyd, C.E.** 1990. *Water quality in ponds for aquaculture*. Auburn, Alabama, USA, Alabama Agricultural Experiment Station.
- Boyd, C. E. & Tucker, C.S.** 1998. *Aquaculture water quality management*. Boston, USA, Kluwer Academic Publishers.
- Boyd, C. & Zimmermann, S.** 2000. Grow-out systems – water quality and soil management. In M.B. New & W.C. Valenti, eds. *Freshwater prawn culture: the farming of *Macrobrachium rosenbergii**, pp. 221-238. Oxford, England, Blackwell Science.
- Chowdhury, R., Bhattacharjee, H. & Angell, C.** 1993. *A manual for operating a small-scale recirculation freshwater prawn hatchery*. Publication No. BOBP/MAG/13. Madras, India, Bay of Bengal Programme.
- Correia, E.S., Suwannatous, S. & New, M.B.** 2000. Flow-through hatchery systems and management. In M.B. New & W.C. Valenti, eds. *Freshwater prawn culture: the farming of *Macrobrachium rosenbergii**. pp. 52-68. Oxford, England, Blackwell Science.
- D'Abramo, L.R. & New, M.B.** 2000. Nutrition, feeds and feeding. In M.B. New & W.C. Valenti, eds. *Freshwater prawn culture: the farming of *Macrobrachium rosenbergii**. pp. 203-220. Oxford, England, Blackwell Science.
- Daniels, W.H., D'Abramo, L.R. & Parseval, L.D.** 1992. Design and management of a closed, recirculating 'clearwater' hatchery system for freshwater prawns, *Macrobrachium rosenbergii* De Man 1879. *Journal of Shellfish Research*, 11:65-73.
- Daniels, W.H., D'Abramo, L.R., Fondren, M.W. & Durant, M.D.** 1995. Effects of stocking density and feed on pond production characteristics and revenue of harvested freshwater prawns *Macrobrachium rosenbergii* stocked as size-graded juveniles. *Journal of the World Aquaculture Society*, 26:38-47.
- Daniels, W.H., Cavalli, R.O. & Smullen, R.P.** 2000. Broodstock management. In M.B. New & W.C. Valenti, eds. *Freshwater prawn culture: the farming of *Macrobrachium rosenbergii**, pp. 41-51. Oxford, England, Blackwell Science.

- Das, N.N., Saad, C.R., Ang, K.J., Law, A.T. & Harmin, S.A.** 1996. Diet formulation for *Macrobrachium rosenbergii* (de Man) broodstock based on essential amino acid profile of its eggs. *Aquaculture Research*, 27:543-555.
- De Man, J.G.** 1879. On some species of the genus *Palaemon* Fabr. with descriptions of two new forms. *Notes Leden Museum*, 1:165-184.
- FAO.** 1981. *Water for freshwater fish culture*. FAO Training Series No. 4. Rome.
- FAO.** 1985. *Soil and freshwater fish culture*. FAO Training Series No. 6. Rome.
- FAO.** 1988. *Topography for freshwater fish culture: topographical tools*. FAO Training Series No. 16/1. Rome.
- FAO.** 1989a. *Aquaculture production (1984-1986)*. FAO Fisheries Circular No. 815. Rome.
- FAO.** 1989b. *Topography for freshwater fish culture: topographical surveys*. FAO Training Series No. 16/2. Rome.
- FAO.** 1992a. *Simple economics and bookkeeping for fish farmers*. FAO Training Series No. 19. Rome.
- FAO.** 1992b. *Pond construction for freshwater fish culture: pond farm structures and layouts*. FAO Training Series No. 20/2. Rome.
- FAO.** 1994. *Handbook on small-scale freshwater fish farming*. FAO Training Series No. 24. Rome.
- FAO.** 1995. *Pond construction for freshwater fish culture: building earthen ponds*. FAO Training Series No. 20/1. Rome.
- FAO.** 1996. *Management for freshwater fish culture: ponds and water practices*. FAO Training Series No. 21/1. Rome.
- FAO.** 1998. *Management for freshwater fish culture: fish stocks and farm management*. FAO Training Series No. 21/2. Rome.
- FAO.** 2001. *Fishery statistics: aquaculture production (1999)*. FAO Fisheries Series No. 58/FAO Statistics Series No. 160. Rome.
- FAO.** 2002. *Fishstat Plus (v.2.30)*, 15.03.2002. Rome, FAO.
- FAO/WHO.** 2001. *Recommended international code of practice for shrimps or prawns*. FAO/WHO - Codex Alimentarius Commission Report No. CAC/RCP/17-1978. Rome.
- Fincham, A.A. & Wickins, J.F.** 1976. *Identification of commercial prawns and shrimps*. British Museum Publication No. 779. London, British Museum.
- Flegel, T.** 2001. Shrimp head meal – does it spread disease ? *Asian Aquaculture Magazine*, July/August 2001:30-31.
- Fonnesbeck, P.V., Harris, L.E. & Kearl, L.C.** 1977. *Proceedings of the First International Symposium on Feed Composition, Animal Requirements, and Computerisation of Diets, 11-16 July, Logan, Utah, USA*. Logan, Utah, USA, Utah Agricultural Experimental Station, Utah State University.
- Fuller, M.J., Kelly, R.A. & Smith, A.P.** 1992. Economic analysis of commercial production of freshwater prawn, *Macrobrachium rosenbergii* De Man 1879 PL using a recirculating 'clearwater' culture system. *Journal of Shellfish Research*, 11:75-80.

- Fujimura, T. & Okamoto, H.** 1972. Notes on progress made in developing a mass culturing technique for *Macrobrachium rosenbergii* in Hawaii. In T.V.R. Pillay, ed. *Coastal aquaculture in the Indo-Pacific region*, pp. 313-327. West Byfleet, England, Fishing News Books.
- Gohl, B.** 1981. *Tropical feeds: feed information summaries and nutritive values*. FAO Animal Production and Health Series No. 12. Rome.
- Graham, J., Johnston, W.A. & Nicholson, F.J.** 1993. *Ice in fisheries*. FAO Fisheries Technical Paper No. 331. Rome.
- Holthuis, L.B.** 1980. *FAO species catalogue. Vol. I. Shrimps and prawns of the world (an annotated catalogue of species of interest to fisheries)*. FAO Fisheries Synopses No. 125 Vol. 1. Rome.
- Holthuis, L.B.** 2000. Nomenclature and taxonomy. In M.B. New & W.C. Valenti, eds. *Freshwater prawn culture: the farming of Macrobrachium rosenbergii*, pp. 12-17. Oxford, England, Blackwell Science.
- ILACO. eds.** 1981. *Agricultural compendium for rural development in the tropics and sub-tropics*. Amsterdam, Elsevier.
- IUCN.** 1996. *1996 IUCN Red List of Threatened Animals*. Gland, Switzerland, IUCN.
- Ismael, D. & New, M.B.** 2000. Biology. In M.B. New & W.C. Valenti, eds. *Freshwater prawn culture: the farming of Macrobrachium rosenbergii*, pp. 18-40. Oxford, England, Blackwell Science.
- Johnson, S.K. & Bueno, S.L.S.** 2000. Health management. In M.B. New & W.C. Valenti, eds. *Freshwater prawn culture: the farming of Macrobrachium rosenbergii*, pp. 239-258. Oxford, England, Blackwell Science.
- Johnston, W.A., Nicholson, F.J., Roger, A. & Stroud, G.D.** 1994. *Freezing and refrigerated storage in fisheries*. FAO Fisheries Technical Paper No. 340. Rome.
- Karplus, I., Malecha, S.R. & Sagi, A.** 2000. The biology and management of size variation. In M.B. New & W.C. Valenti, eds. *Freshwater prawn culture: the farming of Macrobrachium rosenbergii*, pp. 259-289. Oxford, England, Blackwell Science.
- Karplus, I., Hulata, G., Wohlfarth, G.W. & Halevy, A.** 1986. The effect of density of *Macrobrachium rosenbergii* raised in earthen ponds on their population structure and weight distribution. *Aquaculture*, 52:307-320.
- Kutty, M.N., Herman, F. & Le Menn, H.** 2000. Culture of other prawn species. In M.B. New & W.C. Valenti, eds. *Freshwater prawn culture: the farming of Macrobrachium rosenbergii*, pp. 393-410. Oxford, England, Blackwell Science.
- Lavens, P. & Sorgeloos, P. eds.** 1996. *Manual on the production and use of live food for aquaculture*. FAO Fisheries Technical Paper No. 361. Rome.
- Lavens, P., Thongrod, S. & Sorgeloos, P.** 2000. Larval prawn feeds and the dietary importance of *Artemia*. In M.B. New & W.C. Valenti, eds. *Freshwater prawn culture: the farming of Macrobrachium rosenbergii*, pp. 91-111. Oxford, England, Blackwell Science.
- Law, A.T., Wong, Y.P. & Abol-Munafi, A.B.** 2001. Effect of hydrogen ion on *Macrobrachium rosenbergii* (de Man) egg hatchability in brackish water. *Aquaculture* (submitted for publication).

- Ling, S.W.** 1969. Methods of rearing and culturing *Macrobrachium rosenbergii*. *FAO Fisheries Reports* No. 57 Vol. 3:607-619.
- Madrid, R.M.M. & Phillips, H.** 2000. Post-harvest handling and processing. In M.B. New & W.C. Valenti, eds. *Freshwater prawn culture: the farming of Macrobrachium rosenbergii*, pp. 326-344. Oxford, England, Blackwell Science.
- Merchie, G.** 1996. Use of nauplii and meta-nauplii. In P. Lavens & P. Sorgeloos, eds. *Manual on the production and use of live food for aquaculture*, pp. 137-163. FAO Fisheries Technical Paper No. 361. Rome.
- Miao, W. & Ge, X.** 2002. Freshwater prawn farming in China: an overview. *Aquaculture Asia*, VII(1):9-12.
- Moretti, A., Pedini Fernandez-Criado, M., Cittolin, G. & Guidastrì, R.** 1999. *Manual on hatchery production of seabass and gilthead seabream, Volume 1*. Rome, FAO.
- Moretti, A. et al.** 2002. *Manual on hatchery production of seabass and gilthead seabream, Volume 2*. Rome, FAO. (in preparation)
- Muir, J.F. & Lombardi, J.V.** 2000. Grow-out systems – site selection and pond construction. In M.B. New & W.C. Valenti, eds. *Freshwater prawn culture: the farming of Macrobrachium rosenbergii*, pp. 126-156. Oxford, England, Blackwell Science.
- New, M.B.** 1987. *Feed and feeding of fish and shrimp - a manual on the preparation and presentation of compound feeds for shrimp and fish in aquaculture*. Report No. ADCP/REP/87/26. Rome, FAO. [also published in Mandarin and Farsi]
- New, M.B.** 1995. Status of freshwater prawn farming: a review. *Aquaculture Research*, 26:1-54.
- New, M.B.** 2000a. History and global status of freshwater prawn farming. In M.B. New & W.C. Valenti, eds. *Freshwater prawn culture: the farming of Macrobrachium rosenbergii*. pp. 1-11. Oxford, England, Blackwell Science.
- New, M.B.** 2000b. Commercial freshwater prawn farming around the world. In M.B. New & W.C. Valenti, eds. *Freshwater prawn culture: the farming of Macrobrachium rosenbergii*, pp. 290-325. Oxford, England, Blackwell Science.
- New, M.B. & Singholka, S.** 1982. *Freshwater prawn farming: a manual for the culture of Macrobrachium rosenbergii*. FAO Fisheries Technical Paper No. 225. Rome.
- New, M.B. & Singholka, S.** 1985. *Freshwater prawn farming: a manual for the culture of Macrobrachium rosenbergii*. FAO Fisheries Technical Paper No. 225 Rev. 1. Rome. [also published in Farsi, French, Hindi, Spanish, and Vietnamese]
- New, M.B. & Valenti, W.C.** 2000. *Freshwater prawn culture: the farming of Macrobrachium rosenbergii*. Oxford, England, Blackwell Science.
- New, M.B., D'Abramo, L.R., Valenti, W.C. & Singholka, S.** 2000. Sustainability of freshwater prawn culture. In M.B. New & W.C. Valenti, eds. *Freshwater prawn culture: the farming of Macrobrachium rosenbergii*, pp. 429-434. Oxford, England, Blackwell Science.
- New, M.B., Singholka, S. & Kutty, M.N.** 2000. Prawn capture fisheries and enhancement. In M.B. New & W.C. Valenti, eds. *Freshwater prawn culture: the farming of Macrobrachium rosenbergii*, pp. 411-428. Oxford, England, Blackwell Science.



- New, M.B., Singholka, S. & Vorasayan, P.** 1982. Current status of freshwater prawn farming in Thailand. In M.B. New, ed. *Developments in aquaculture and fisheries science, Volume 10: Giant prawn farming*. pp. 333-349. Amsterdam, Elsevier.
- New, M.B., Tacon, A.G.J. & Csavas, I.** 1995. *Farm-made aquafeeds*. FAO Fisheries Technical Paper No. 343. Rome.
- Pinheiro, M.A.A. & Hebling, N.J.** 1998. Biologia de *Macrobrachium rosenbergii* (De Man, 1879). In W.C. Valenti. (ed). *Carcinicultura de água doce. Tecnologia para produção de camarões*, pp. 21-46. Brasília, IBAMA.
- Phillips, H. & Lacroix, D.** 2000. Marketing and preparation for consumption. In M.B. New & W.C. Valenti, eds. *Freshwater prawn culture: the farming of Macrobrachium rosenbergii*, pp. 345-368. Oxford, England, Blackwell Science.
- Reddy, G.A. & Rao, P.L.M.K.** 2001. Freshwater prawn farming: a proven success in India. *Fish Farmer*, 24(5):32-34.
- Rhodes, R.J.** 2000. Economics and business management. In M.B. New & W.C. Valenti, eds. *Freshwater prawn culture: the farming of Macrobrachium rosenbergii*, pp. 369-392. Oxford, England, Blackwell Science.
- Spotte, S.** 1970. *Fish and invertebrate culture: water management in closed systems*. New York, Wiley-Interscience.
- Suwannatous, S. & New, M.B.** 1982. Development of a shallow beach well for hatcheries requiring seawater. In M.B. New. ed. *Developments in aquaculture and fisheries science, Volume 10: Giant prawn farming*, pp. 303-307. Amsterdam, Elsevier.
- Tacon, A.G.J.** 1987. *The nutrition and feeding of farmed fish and shrimp - a training manual, Volume 2: nutrient sources and composition*. Report No. GCP/RLA/075/ITA Field Document 5/E. Rome, FAO.
- Tacon, A.G.J.** 1993a. *Feed ingredients for warmwater fish: fish meal and other processed feedstuffs*. FAO Fisheries Circular No. 856. Rome.
- Tacon, A.G.J.** 1993b. *Feed ingredients for crustaceans: natural foods and processed feedstuffs*. FAO Fisheries Circular No. 866. Rome.
- Tayamen, M. & Brown, J.H.** 1999. A condition index for evaluating larval quality of *Macrobrachium rosenbergii* (De Man, 1879). *Aquaculture Research*, 30:917-922.
- Tave, D.** 1996. *Selective breeding programmes for medium-sized fish farms*. FAO Fisheries Technical Paper No. 352. Rome.
- Tave, D.** 1999. *Inbreeding and broodstock management*. FAO Fisheries Technical Paper No. 392. Rome.
- Tidwell, J.H. & D'Abramo, L.R.** 2000. Grow-out systems - culture in temperate zones. In M.B. New & W.C. Valenti, eds. *Freshwater prawn culture: the farming of Macrobrachium rosenbergii*, pp. 177-186. Oxford, England, Blackwell Science.
- Tidwell, J.H., Coyle, S.D. & Schulmeister, G.** 1998. Effects of added substrate on the production and population characteristics of freshwater prawns *Macrobrachium rosenbergii* in ponds. *Journal of the World Aquaculture Society*, 29:17-22.

- Uno, Y. & Kwon, S.** 1969. Larval development of *Macrobrachium rosenbergii* reared in the laboratory. *Journal of the Tokyo University of Fisheries*, 55(2):179-190.
- Valenti, W.C. & Daniels, W.** 2000. Recirculation hatchery systems and management. In M.B. New & W.C. Valenti, eds. *Freshwater prawn culture: the farming of Macrobrachium rosenbergii*, pp. 69-90. Oxford, England, Blackwell Science.
- Valenti, W.C. & New, M.B.** 2000. Grow-out systems - monoculture. In M.B. New & W.C. Valenti, eds. *Freshwater prawn culture: the farming of Macrobrachium rosenbergii*, pp. 157-176. Oxford, England, Blackwell Science.
- Van Stappen, G.** 1996. Introduction, biology and ecology of *Artemia*. In P. Lavens & P. Sorgeloos, eds. *Manual on the production and use of live food for aquaculture*, pp. 79-136. FAO Fisheries Technical Paper No. 361. Rome.
- Van Wyk, P. et al.** 1999. *Farming marine shrimp in recirculating freshwater systems*. Report under Contract No. 4520, Florida Department of Agriculture and Consumer Services. Harbor Branch Oceanographic Institution. USA, Fort Pierce, Florida.
- Wheaton, F.W.** 1977. *Aquacultural engineering*. New York, John Wiley & Sons.
- Wickins, J.F.** 1972. *Experiments on the culture of the spot prawn Pandalus platyceros and the giant freshwater prawn Macrobrachium rosenbergii*. Fisheries Investigations, London, Series 2, 27(5). London, Ministry of Agriculture, Fisheries & Food.
- Zimmermann, S. & New, M.B.** 2000. Grow-out systems - polyculture and integrated culture. In M.B. New & W.C. Valenti, eds. *Freshwater prawn culture: the farming of Macrobrachium rosenbergii*, pp. 187-202. Oxford, England, Blackwell Science.

This new manual, which replaces an earlier manual first issued in 1982, is an up-to-date practical guide to the farming of *Macrobrachium rosenbergii*. Many of the techniques described are also applicable to the culture of other species of freshwater prawns. The principal target audience is farmers and extension workers but it is also hoped that it will be useful for aquaculture lecturers and students. After a preliminary section on the biology of freshwater prawns, the manual covers site selection for hatcheries, nurseries and grow-out facilities, and the management of the broodstock, hatchery, nursery and grow-out phases of rearing. Harvesting and post-harvest handling are also covered and there are some notes on marketing freshwater prawns. The reference and bibliography section contains a list of relevant reviews, as well as other (mainly FAO) manuals on general aquaculture themes, such as water and soil management, topography, pond construction and simple economics. The management principles described are illustrated by photographs and drawings. The manual contains annexes on specific topics such as the production of larval feeds, size variation and stock estimation. The final annex is a glossary that lists not only the terms used in the manual itself but also those that may be found in other documents.

